

COOL NEW PRODUCTS

8808



Oil Drain Plug & Gasket Assortment

BACK OF TRAY							
# 8808 Oil Drain Plug & Gasket Assortment							
17618PK 1/2" .20 x 13/16" 5/8" Hex Size 1.332" O.D. Flange Size Black Finish W/ Rubber Gasket, Oil Drain Plugs	17614PK 12-1.25 x 11mm 14mm Hex Size 20mm O.D. Flange Size Zinc Finish Oil Drain Plugs	17617PK 12-1.25 x 12mm 14mm Hex Size 32mm O.D. Flange Size Yellow Zinc Oil Drain Plugs	17615PK 12-1.25 x 17mm 14mm Hex Size 20mm O.D. Flange Size Zinc Finish Oil Drain Plugs	17623PK 12-1.75 x 25mm 13mm Hex Size 26mm O.D. Flange Black Finish W/Rubber Gasket, Oil Drain Plugs	11972PK 12mm-1.75 x 26mm 15mm Hex Size 22mm O.D. Flange Size Bright Zinc Finish Oil Drain Plugs W/Gasket	17620PK 12-1.75 x 30mm 13mm Hex Size 26mm O.D. Flange Bright Zinc W/Rubber Gasket, Magnetic Oil Drain Plugs	17616PK 14-1.50 x 10mm 17mm Hex Size 24mm O.D. Flange Size Yellow Zinc Finish Oil Drain Plug
17625PK 12-1.75 x 25mm 15mm Hex Size 26mm O.D. Flange Size Yellow Zinc W/Gasket Oil Drain Plug	17624PK 14-1.50 x 15mm 17mm Hex Size 24mm O.D. Flange Size Yellow Zinc Oil Drain Plug	17612PK 14-1.50 x 16mm 13mm Hex Size 23mm O.D. Flange Size Zinc Finish Oil Drain Plug	17613PK 14-1.50 x 20 mm 16mm Hex Size 25mm O.D. Flange Size Zinc Finish Oil Drain Plug	17622PK 14-1.50 x 20mm 16mm Hex Size 28mm O.D. Flange Black Finish W/Rubber Gasket, Oil Drain Plugs	17621PK 14-1.50 x 20mm 13mm Hex Size 28mm O.D. Flange Size Black Finish W/Rubber Gasket, Oil Drain Plugs	11970PK 14-1.50 x 20mm 13mm Hex Size 28.5mm O.D. Flange Size Bright Zinc Finish W/Gasket, Oil Drain Plug	17744PK 14-1.50 x 34mm 13mm Hex Size 19mm O.D. Flange Size Yellow Zinc Finish Oil Drain Plugs
17634PK 1/2" Inside Diameter 15/16" Outside Diameter 5/64" Thickness Black Fiber Oil Drain Plug Gaskets	17631PK 1/2" Inside Diameter 1" Outside Diameter 3/64" Thickness Steel With Rubber Seal Oil Drain Plug Gaskets	11969PK 11mm I.D., 21mm O.D. 3mm Thickness For 12-1.75 Drain Plugs Black Rubber Oil Drain Plug Gaskets	17626PK 12mm Inside Diameter 18mm Outside Diameter 2mm Thickness Copper Finish Oil Drain Plug Gaskets	9994PK 12mm I.D., 21mm O.D. 1.75mm Thickness Blue Coated Aluminum & Fibre Oil Plug Gaskets	17630PK 12mm Inside Diameter 22mm Outside Diameter 1.50mm Thickness Copper Finish Oil Drain Plug Gaskets	12134PK 12mm Inside Diameter 22mm Outside Diameter 2mm Thickness Black Fiber Oil Drain Gaskets	17629PK 12mm Inside Diameter 22mm Outside Diameter 2mm Thickness Aluminum Type Oil Drain Plug Gaskets
12097PK 14mm Inside Diameter 20mm Outside Diameter 2mm Thickness Copper Crushable Oil Drain Plug Gaskets	15138PK 14mm Inside Diameter 20mm Outside Diameter 2mm Thickness Aluminum Type Oil Drain Plug Gaskets	11971PK 14mm Inside Diameter 22mm Outside Diameter 1.5mm Thickness Copper Oil Drain Plug Gaskets	11999PK 14mm Inside Diameter 22mm Outside Diameter 2mm Thickness Aluminum Type Oil Drain Plug Gaskets	12096PK 14mm Inside Diameter 24mm Outside Diameter 2mm Thickness Black Fiber Oil Drain Plug Gaskets	17632PK 14mm Inside Diameter 25mm Outside Diameter 1.00mm Thickness Steel With Rubber Seal Oil Drain Plug Gaskets	17627PK 16mm Inside Diameter 21mm Outside Diameter 2mm Thickness Steel Crushable Oil Drain Plug Gaskets	17754PK 20mm Inside Diameter 28mm Outside Diameter 2mm Thickness Steel Finish Oil Drain Plug Gaskets
FRONT OF TRAY							

Contains 32 Different Sizes
224 Total Pieces
Adjustable Gray Plastic Tray
Oil Drain Plug &
Gasket Assortment



Part #	Tray Type	Material	Tray #	Tray Color	Lid Color	Label Type	Clear Pocket	Qty.	
8808	Adjustable	Plastic	80132	Gray	Gray	Adhesive	No	1 Pc.	NEW
8808BCP	Adjustable	Plastic	80156BC	Dark Blue	Clear	Paper	Yes	1 Pc.	NEW
8808GCP	Adjustable	Plastic	80132GC	Gray	Clear	Paper	Yes	1 Pc.	NEW
8808RCP	Adjustable	Plastic	80153RC	Red	Clear	Paper	Yes	1 Pc.	NEW
8808YCP	Adjustable	Plastic	80132YC	Yellow	Clear	Paper	Yes	1 Pc.	NEW

Disco Automotive Hardware

Ph: 580-622-3090

Fax: 580-622-3781

discosales@discoautomotive.com

CNP1

COOL NEW PRODUCTS

8809



Oil Drain Plug Assortment

BACK OF TRAY																							
# 8809																							
Oil Drain Plug Assortment																							
17736PK		1/2-20 x 13/16" 9/16" Hex Size 7/8" O.D. Flange Size Bright Zinc Finish Oil Drain Plugs	1	17614PK		12-1.25 x 11mm 14mm Hex Size 20mm O.D. Flange Size Zinc Finish Oil Drain Plugs	2	17617PK		12-1.25 x 12mm 14mm Hex Size 32mm O.D. Flange Size Yellow Zinc Oil Drain Plugs	3	17615PK		12-1.25 x 17mm 14mm Hex Size 20mm O.D. Flange Size Zinc Finish Oil Drain Plugs	4	17623PK		12-1.75 x 25mm 13mm Hex Size 26mm O.D. Flange Black Finish W/Rubber Gasket Oil Drain Plugs	5	17618PK		1/2" - 20 x 13-16" 14mm Hex Size 1-3/32" O.D. Flange Size Black Finish W/Rubber Gasket Oil Drain Plugs	6
11972PK		12mm-1.75 x 26mm 15mm Hex Size 22mm O.D. Flange Size Bright Zinc Finish Oil Drain Plugs W/ Gasket	7	17620PK		12-1.75 x 30mm 13mm Hex Size 26mm O.D. Flange Bright Zinc W/Rubber Gasket Oil Drain Plugs	8	17616PK		14-1.50 x 10mm 17mm Hex Size 24mm O.D. Flange Size Yellow Zinc Finish Oil Drain Plug	9	12095PK		14-1.50 x 11mm 16mm Hex Size 25mm O.D. Flange Size Bright Zinc Finish Oil Drain Plug With Gasket	10	17624PK		14-1.50 x 15mm 17mm Hex Size 24mm O.D. Flange Size Yellow Zinc Finish Oil Drain Plugs	11	17746PK		12-1.75 x 19mm 14mm Hex Size 31mm O.D. Flange Size Black W/Rubber Gasket Oil Drain Plug	12
17745PK		14-1.25 x 16mm 13mm Hex Size 23mm O.D. Flange Size Zinc Finish Oil Drain Plug	13	17747PK		14-1.25 x 17mm 19mm Hex Size Zinc Finish Oversize Oil Drain Plug	14	17612PK		14-1.50 x 16mm 13mm Hex Size 23mm O.D. Flange Size Zinc Finish Oil Drain Plug	15	17619PK		14-1.50 x 18mm 17mm Hex Size 28mm O.D. Flange Size Black Finish W/Rubber Gasket Oil Drain Plug	16	17613PK		14-1.50 x 20mm 16mm Hex Size 25mm O.D. Flange Size Zinc Finish Oil Drain Plug	17	17625PK		12-1.75 x 25mm 15mm Hex Size 26mm O.D. Flange Size Yellow Zinc With Gasket Oil Drain Plug	18
17622PK		14-1.50 x 20mm 16mm Hex Size 28mm O.D. Flange Black Finish W/Rubber Gasket Oil Drain Plugs	19	17621PK		14-1.50 x 20mm 13mm Hex Size 28mm O.D. Flange Black Finish W/Rubber Gasket Oil Drain Plugs	20	11970PK		14-1.50 x 20mm 13mm Hex Size 28.5mm O.D. Flange Size Bright Zinc Finish Oil Drain Plug With Gasket	21	17744PK		14-1.50 x 24mm 19mm O.D. Flange Size Yellow Zinc Finish Oil Drain Plugs	22	17751PK		14-1.50 x 20mm 19mm Hex Size 20mm O.D. Sems® Washer Zinc Finish Oil Drain Plugs	23	17749PK		1/2-3/4" or 12-18mm Hole Size 2" Shaft Length Steel Yellow Zinc Finish Universal Winged Oil Drain Plugs	24

FRONT OF TRAY

Contains 24 Different Sizes
 96 Total Pieces
 1/2-20, 12x1.25, 12x1.75
 14x1.25, 14x1.50 Hole Sizes
 Oil Drain Plug Assortment



Part #	Tray Type	Material	Tray #	Tray Color	Lid Color	Label Type	Clear Pocket	Qty.	
8809	24 Hole	Plastic	80123	Gray	Gray	Adhesive	No	1 Pc.	NEW
8809BCP	24 Hole	Plastic	80155BC	Dark Blue	Clear	Paper	Yes	1 Pc.	NEW
8809GCP	24 Hole	Plastic	80123GC	Gray	Clear	Paper	Yes	1 Pc.	NEW
8809RCP	24 Hole	Plastic	80152RC	Red	Clear	Paper	Yes	1 Pc.	NEW
8809YCP	24 Hole	Plastic	80123YC	Yellow	Clear	Paper	Yes	1 Pc.	NEW

Disco Automotive Hardware

Ph: 580-622-3090

Fax: 580-622-3781

discosales@discoautomotive.com

CNP2

COOL NEW PRODUCTS

8810



Oil Drain Gasket Assortment

BACK OF TRAY							
# 8810							
Oil Drain Gasket Assortment							
17634PK 1 1/2" Inside Diameter 15/16" Outside Diameter 5/64" Thickness Black Fiber Oil Drain Plug Gaskets 1	17752PK 1/2" Inside Diameter 3/4" Outside Diameter 5/64" Thickness Copper Crushable Oil Drain Gaskets 2	17757PK 1/2" Inside Diameter 7/8" Outside Diameter 7/64" Thickness Black Fiber Oil Drain Gaskets 3	17755PK 1/2" Inside Diameter 7/8" Outside Diameter 1/16" Thickness Aluminum Type Oil Drain Gaskets 4	17631PK 1 1/2" Inside Diameter 1" Outside Diameter 3/64" Thickness Steel With Rubber Seal Oil Drain Plug Gaskets 5	11969PK 11mm I.D. 21mm O.D. 3mm Thickness For 12-1.75 Drain Plugs Black Rubber Oil Drain Plug Gaskets 6	17910PK 12mm Inside Diameter 22mm Outside Diameter 1.6mm Thickness Green Synthetic Oil Drain Plug Gaskets 7	12188PK 12mm I.D. 17.7mm O.D. 3mm Thickness For 12-1.25mm Oil Drain Plugs Copper Crushable Oil Drain Plug Gaskets 8
17626PK 12mm Inside Diameter 18mm Outside Diameter 2mm Thickness Copper Finish Oil Drain Plug Gaskets 9	9994PK 12mm I.D. 21mm O.D. 1.75mm Thickness Blue Coated Aluminum & Fiber Oil Plug Gaskets 10	12590PK 12mm Inside Diameter 22mm Outside Diameter 1.50mm Thickness Natural Nylon Oil Drain Gaskets 11	17633PK 12mm Inside Diameter 21mm Outside Diameter 1.80mm Thickness Blue Coated Aluminum & Fiber Oil Drain Plug Gaskets 12	17630PK 12mm Inside Diameter 22mm Outside Diameter 1.50mm Thickness Copper Finish Oil Drain Plug Gaskets 13	12134PK 12mm Inside Diameter 22mm Outside Diameter 2mm Thickness Black Fiber Oil Drain Gaskets 14	17629PK 12mm Inside Diameter 22mm Outside Diameter 2mm Thickness Aluminum Type Oil Drain Plug Gaskets 15	17756PK 14mm Inside Diameter 20mm Outside Diameter 1.50mm Thickness Copper Finish Oil Drain Plug Gaskets 16
11846PK 14mm Inside Diameter 20mm Outside Diameter 1.50mm Thickness Aluminum Type Oil Drain Plug Gaskets 17	15138PK 14mm Inside Diameter 20mm Outside Diameter 2mm Thickness Aluminum Type Oil Drain Plug Gaskets 18	12097PK 14mm Inside Diameter 20mm Outside Diameter 2mm Thickness Copper Crushable Oil Drain Plug Gaskets 19	11971PK 14mm Inside Diameter 22mm Outside Diameter 1.50mm Thickness Copper Oil Drain Plug Gaskets 20	11999PK 14mm Inside Diameter 22mm Outside Diameter 2mm Thickness Aluminum Type Oil Drain Plug Gaskets 21	12096PK 14mm Inside Diameter 24mm Outside Diameter 2mm Thickness Black Fiber Oil Drain Plug Gaskets 22	17632PK 14mm Inside Diameter 25mm Outside Diameter 1.00mm Thickness Steel With Rubber Seal Oil Drain Plug Gaskets 23	17627PK 16mm Inside Diameter 21mm Outside Diameter 2mm Thickness Steel Crushable Oil Drain Plug Gaskets 24
17753PK 16mm Inside Diameter 22mm Outside Diameter 2mm Thickness Copper Finish Oil Drain Plug Gaskets 25	11847PK 18mm Inside Diameter 20mm Outside Diameter 1.50mm Thickness Aluminum Type Oil Drain Plug Gaskets 26	12000PK 18mm Inside Diameter 25.50mm Outside Diameter 2mm Thickness Aluminum Type Oil Drain Plug Gaskets 27	17628PK 20mm Inside Diameter 26mm Outside Diameter 2mm Thickness Copper Crushable Oil Drain Plug Gaskets 28	17754PK 20mm Inside Diameter 26mm Outside Diameter 2mm Thickness Steel Finish Oil Drain Plug Gaskets 29			
FRONT OF TRAY							

Contains 29 Different Sizes
290 Total Pieces
1/2", 11mm, 12mm, 14mm
Oil Drain Gasket Assortment



Part #	Tray Type	Material	Tray #	Tray Color	Lid Color	Label Type	Clear Pocket	Qty.	
8810	Adjustable	Plastic	80132	Gray	Gray	Adhesive	No	1 Pc.	NEW
8810BCP	Adjustable	Plastic	80156BC	Dark Blue	Clear	Paper	Yes	1 Pc.	NEW
8810GCP	Adjustable	Plastic	80132GC	Gray	Clear	Paper	Yes	1 Pc.	NEW
8810RCP	Adjustable	Plastic	80153RC	Red	Clear	Paper	Yes	1 Pc.	NEW
8810YCP	Adjustable	Plastic	80132YC	Yellow	Clear	Paper	Yes	1 Pc.	NEW

Disco Automotive Hardware

Ph: 580-622-3090

Fax: 580-622-3781

discosales@discoautomotive.com

CNP3

COOL NEW PRODUCTS

8811



Self Piercing Rivet (SPR) Assortment

BACK OF TRAY					
# 8811 Self Piercing Rivet (SPR) Assortment					
18121PK 3.35 x 3.5mm Silver Steel H4 ALMAC Self Piercing Rivets (SPR) 1	18122PK 3.35 x 4.0mm Silver Steel H4 ALMAC Self Piercing Rivets (SPR) 2	18123PK 3.35 x 5.0mm Silver Steel H4 ALMAC Self Piercing Rivets (SPR) 3	18124PK 3.35 x 6.0mm Silver Steel H4 ALMAC Self Piercing Rivets (SPR) 4	18125PK 5.3 x 4.0mm Silver Steel H4 ALMAC Self Piercing Rivets (SPR) 5	18219 Removes 5.30mm Diameter Self Piercing Rivets Uses a Grade 8 Bolt Heavy Duty 6
7	18126PK 5.3 x 5.0mm Silver Steel H4 ALMAC Self Piercing Rivets (SPR) 8	18127PK 5.3 x 6.0mm Silver Steel H4 ALMAC Self Piercing Rivets (SPR) 9	18128PK 5.3 x 6.5mm Silver Steel H4 ALMAC Self Piercing Rivets (SPR) 10	18129PK 5.3 x 7.0mm Silver Steel H4 ALMAC Self Piercing Rivets (SPR) 11	12
18130PK 5.3 x 7.5mm Silver Steel H4 ALMAC Self Piercing Rivets (SPR) 13	18131PK 5.3 x 8.0mm Silver Steel H4 ALMAC Self Piercing Rivets (SPR) 14	18132PK 5.3 x 9.0mm Silver Steel H4 ALMAC Self Piercing Rivets (SPR) 15	16	17	18220 Installs 5.30mm Diameter Self Piercing Rivets Uses a Grade 8 Bolt Heavy Duty SPR Installs Tool 18
19	13328PK 1/4" (6.30mm) Diameter 1/2" Flange Size .060" - .138" Grip Range F-150 Trucks With Alum. Body All Steel Pop Rivets 20	12623PK 1/4" (6.30mm) Diameter 1/2" Flange Size .110" - .189" Grip Range F-150 Trucks With Alum. Body All Steel Pop Rivets 21	12625PK 1/4" (6.30mm) Diameter 1/2" Flange Size .189" - .238" Grip Range F-150 Trucks With Alum. Body All Steel Pop Rivets 22	13329PK 1/4" (6.30mm) Diameter 1/2" Flange Size .268" - .346" Grip Range F-150 Trucks With Alum. Body All Steel Pop Rivets 23	24
FRONT OF TRAY					

Contains 12 Different SPR
 Contains 4 Different Pop Rivets
 1,160 Total Rivets
 1 Extraction & 1 Insertion Tool
 Self Piercing Rivet Assortment



Part #	Tray Type	Material	Tray #	Tray Color	Lid Color	Label Type	Clear Pocket	Qty.	
8811	24 Hole	Plastic	80123	Gray	Gray	Adhesive	No	1 Pc.	NEW
8811BCP	24 Hole	Plastic	80155BC	Dark Blue	Clear	Paper	Yes	1 Pc.	NEW
8811GCP	24 Hole	Plastic	80123GC	Gray	Clear	Paper	Yes	1 Pc.	NEW
8811RCP	24 Hole	Plastic	80152RC	Red	Clear	Paper	Yes	1 Pc.	NEW
8811YCP	24 Hole	Plastic	80123YC	Yellow	Clear	Paper	Yes	1 Pc.	NEW

Disco Automotive Hardware

Ph: 580-622-3090

Fax: 580-622-3781













discosales@discoautomotive.com

CNP4

COOL NEW PRODUCTS

Assortments

Rivets Self Piercing (SPR)

# 8214 Self Piercing Rivet Assortment					
# 18121PK  3.35 x 3.50mm Silver Steel H4 ALMAC Self Piercing Rivets	# 18122PK  3.35 x 4.0mm Silver Steel H4 ALMAC Self Piercing Rivets	# 18123PK  3.35 x 5.0mm Silver Steel H4 ALMAC Self Piercing Rivets	# 18124PK  3.35 x 6.0mm Silver Steel H4 ALMAC Self Piercing Rivets	# 18125PK  5.30 x 4.0mm Silver Steel H4 ALMAC Self Piercing Rivets	# 18126PK  5.30 x 5.0mm Silver Steel H4 ALMAC Self Piercing Rivets
# 18127PK  5.30 x 6.0mm Silver Steel H4 ALMAC Self Piercing Rivets	# 18128PK  5.30 x 6.50mm Silver Steel H4 ALMAC Self Piercing Rivets	# 18129PK  5.30 x 7.0mm Silver Steel H4 ALMAC Self Piercing Rivets	# 18130PK  5.30 x 7.50mm Silver Steel H4 ALMAC Self Piercing Rivets	# 18131PK  5.30 x 8.0mm Silver Steel H4 ALMAC Self Piercing Rivets	# 18132PK  5.30 x 9.0mm Silver Steel H4 ALMAC Self Piercing Rivets



Contains 12 Different Sizes
 1,100 Total Pieces
 6 3/4" x 11" Plastic Tray
 Silver Steel H4 ALMAC
 Self Piercing Rivet Assortment

**Sold
 Each**

Tools & Supplies

High Tungsten Steel Reamers



Gold surface treated body, these reamers are especially designed for the reaming of structural steel plates found in truck frames, rail cars, bridges and pressure vessels. For use only to enlarge previously formed or drilled holes.

Part #	Shank Diameter	Starting Hole	Flats On Shank	Overall Length	Finish	Qty.
18195	1/2"	3/8" Min.	3	5 7/8"	Gold	1 Pc.
18197	5/8"	7/16" Min.	3	6 3/8"	Gold	1 Pc.
18200	3/4"	1/2" Min.	3	6 7/8"	Gold	1 Pc.
18205	1"	7/8" Min.	3	6 7/8"	Gold	1 Pc.

Disco Automotive Hardware

Ph: 580-622-3090

Fax: 580-622-3781

discosales@discoautomotive.com

CNP5

06/19/19

COOL NEW PRODUCTS

8812



Universal Door Panel Assortment

BACK OF TRAY

8812
Universal Door Panel Assortment

1646PK 1/4" (6.50mm) Hole Size 21mm Stem Length 6.30mm x 11.50mm Head Dia. Natural Nylon Door Trim Panel Retainers 1	9339PK 9/32" (7mm) Hole Size 19mm Stem Length 7mm x 12.50mm Head Size White Nylon Door Trim Panel Retainers 2	2034PK 13/64" (5mm) Hole Size 15mm Stem Length 20mm Head Diameter Black Nylon Door Trim Panel Retainers 3	10403PK 9/32" (7mm) Hole Size 22mm Stem Length 19mm Head Diameter Black Nylon Door Trim Panel Retainers 4	9861PK 15/64" (6mm) Hole Size 24mm Stem Length 18mm Head Diameter White Nylon Door Trim Panel Retainers 5	2063PK 9/32" (7mm) Hole Size 15mm Stem Length 13mm Head Diameter White Nylon Door Trim Panel Retainers 6	2112PK 9/32" (7mm) Hole Size 19mm Stem Length 12.50mm Top Head Diameter Black Nylon Door Trim Panel Retainers 7	10649PK 9/32" (7mm) Hole Size 14.50mm Stem Length 15mm Head Diameter Yellow Nylon Door Trim Panel Retainers 8
1558PK 9/32" (7mm) Hole Size 19mm Stem Length 13.30mm Top Head Diameter Natural Nylon Door Trim Panel Retainers 9	9514PK 9/32" (7mm) Hole Size 22mm Stem Length 13mm Top Head Diameter Natural Nylon Door Trim Panel Retainers 10	1742PK 5/16" (8mm) Hole Size 1" Stem Length 1/2" Top Head Diameter Natural Nylon Door Trim Panel Retainers 11	1807PK 9/32" (7mm) Hole Size 24mm Stem Length 18mm Head Diameter White Nylon Door Trim Panel Retainers 12	10576PK 5/16" (8mm) Hole Size 14mm Stem Length 12.80mm Head Diameter Orange Nylon With Sealer Door Trim Panel Retainers 13	12886PK 5/16" (8mm) Hole Size 3/4" Stem Length 1/2" Top Head Diameter Yellow Nylon Door Trim Panel Retainers 14	9372PK 5/16" (8mm) Hole Size 21/32" Stem Length 13mm Head Diameter White Nylon Door Trim Panel Retainers 15	9444PK 5/16" (8mm) Hole Size 15mm Stem Length 13mm Head Diameter White Nylon Door Trim Panel Retainers 16
9539PK 5/16" (8mm) Hole Size 17.50mm Stem Length 13mm Head Diameter Natural Nylon Door Trim Panel Retainers 17	1575PK 5/16" (8mm) Hole Size 12.70mm Top Head Diameter Black Nylon Door Trim Panel Retainers 18	10573PK 21/64" (6.50mm) Hole Size 13mm Stem Length 13mm Top Head Diameter Blue Nylon Door Trim Panel Retainers 19	10724PK 23/64" (8mm) Hole Size 13mm Stem Length 13mm Top Head Diameter White Nylon With Sealer Door Trim Panel Retainers 20	2108PK 3/8" (9.50mm) Hole Size 15mm Stem Length 15mm Top Head Diameter White Nylon Door Trim Panel Retainers 21	10701PK 3/8" (9.50mm) Hole Size 17mm Stem Length 19.50mm Top Head Diameter White Nylon With Sealer Door Trim Panel Retainers 22	4020PK 1/4" (6.50mm) Hole Size 6.30mm x 11.50mm Top Head Natural Nylon Door Trim Panel Retainers 23	9242PK 1/4" (6.50mm) Hole Size 21mm Stem Length 17mm Head Diameter Natural Nylon Door Trim Panel Retainers 24
592PK 9/32" (7mm) Hole Size 14.80mm Stem Length 17.6mm Head Diameter Natural Nylon Door Trim Panel Retainers 25	9373PK 9/32" (7mm) Hole Size 18mm Stem Length 13mm Head Diameter Black Nylon Door Trim Panel Retainers 26	1716PK 9/32" (7mm) Hole Size 25mm Stem Length 17mm Head Diameter Natural Nylon Door Trim Panel Retainers 27	9502PK 9/32" (7mm) Hole Size 27mm Stem Length 22mm Head Diameter White Nylon Door Trim Panel Retainers 28	12463PK 23/64" (8mm) Hole Size 15mm Stem Length 14mm Top Head Diameter White Nylon Door Trim Panel Retainers 29	5264PK 1/4" (6.50mm) Hole Size 29/32" Stem Length 29/32" Head Diameter Natural Nylon Door Trim Panel Retainers 30	1648PK 9/32" (7mm) Hole Size 24mm Stem Length 20mm Top Head Diameter White Nylon Door Trim Panel Retainers 31	9368PK 9/32" (7mm) Hole Size 32mm Stem Length 20mm Top Head Diameter Natural Nylon Door Trim Panel Retainers 32

FRONT OF TRAY

Contains 32 Different Sizes
320 Total Pieces
Adjustable Gray Tray
Universal Door Trim
Panel Assortment



Part #	Tray Type	Material	Tray #	Tray Color	Lid Color	Label Type	Clear Pocket	Qty.	
8812	Adjustable	Plastic	80132	Gray	Gray	Adhesive	No	1 Pc.	NEW
8812BCP	Adjustable	Plastic	80156BC	Dark Blue	Clear	Paper	Yes	1 Pc.	NEW
8812GCP	Adjustable	Plastic	80132GC	Gray	Clear	Paper	Yes	1 Pc.	NEW
8812RCP	Adjustable	Plastic	80153RC	Red	Clear	Paper	Yes	1 Pc.	NEW
8812YCP	Adjustable	Plastic	80132YC	Yellow	Clear	Paper	Yes	1 Pc.	NEW

Disco Automotive Hardware

Ph: 580-622-3090

Fax: 580-622-3781

discosales@discoautomotive.com

CNP6

10/21/19

COOL NEW PRODUCTS

Standard Fasteners

Nuts Hex SAE Prevailing Torque Lock Grade "C" Zinc & Wax Finish



Part #	Size	Hex Size	Grade	Material	Qty.
12870PK	1/4-28 (SAE)	7/16"	"C"	Zinc & Waxed	100 Pcs. NEW
12871PK	5/16-24 (SAE)	1/2"	"C"	Zinc & Waxed	100 Pcs. NEW
12872PK	3/8-24 (SAE)	9/16"	"C"	Zinc & Waxed	100 Pcs. NEW
12873PK	7/16-20 (SAE)	11/16"	"C"	Zinc & Waxed	50 Pcs. NEW
12874PK	1/2-20 (SAE)	3/4"	"C"	Zinc & Waxed	50 Pcs. NEW
12875PK	9/16-18 (SAE)	7/8"	"C"	Zinc & Waxed	25 Pcs. NEW
12876PK	5/8-18 (SAE)	15/16"	"C"	Zinc & Waxed	25 Pcs. NEW
12877PK	3/4-16 (SAE)	1-1/8"	"C"	Zinc & Waxed	25 Pcs. NEW
12878PK	7/8-14 (SAE)	1-5/16"	"C"	Zinc & Waxed	10 Pcs. NEW
12879PK	1-14 (SAE)	1-1/2"	"C"	Zinc & Waxed	10 Pcs. NEW

Metric Fasteners

Bolts Hex Flange Class 10.9 DIN 6921 Bright Zinc



Part #	Size	Hex Size	Flange Size	Finish	Qty.
17948PK	10-1.50 x 20mm	15mm Indented	22.30mm	Bright Zinc	10 Pcs. NEW
17949PK	10-1.50 x 25mm	15mm Indented	22.30mm	Bright Zinc	10 Pcs. NEW
17950PK	10-1.50 x 30mm	15mm Indented	22.30mm	Bright Zinc	10 Pcs. NEW
17951PK	10-1.50 x 35mm	15mm Indented	22.30mm	Bright Zinc	10 Pcs. NEW
17952PK	10-1.50 x 40mm	15mm Indented	22.30mm	Bright Zinc	10 Pcs. NEW
17953PK	10-1.50 x 45mm	15mm Indented	22.30mm	Bright Zinc	10 Pcs. NEW
17954PK	10-1.50 x 50mm	15mm Indented	22.30mm	Bright Zinc	10 Pcs. NEW
17956PK	10-1.50 x 60mm	15mm Indented	22.30mm	Bright Zinc	10 Pcs. NEW
17958PK	10-1.50 x 70mm	15mm Indented	22.30mm	Bright Zinc	10 Pcs. NEW
17960PK	10-1.50 x 80mm	15mm Indented	22.30mm	Bright Zinc	10 Pcs. NEW
17962PK	10-1.50 x 90mm	15mm Indented	22.30mm	Bright Zinc	10 Pcs. NEW

Nuts Hex Flange Class 10 DIN 6923 Bright Zinc

17946PK 10-1.50mm Class 10
15mm Hex Size
21.80mm Serrated Flange
Bright Zinc Finish
Metric Spin Lock Nuts
DIN 6923

25 Pcs.



Disco Automotive Hardware

Ph: 580-622-3090

Fax: 580-622-3781

discosales@discoautomotive.com

CNP7

06/26/19

COOL NEW PRODUCTS

Ford Clips & Fasteners

Nuts Specialty

18096PK #8 (4.20mm) Screw Size
11.70mm Width
16.50mm Length
Gray Finish With Sealer
Specialty Nuts
Ford # W713617-S439

15 Pcs.



17908PK #10 (4.80mm) Screw Size
11mm Stem Length
20mm Head Diameter
11.50 x 7.50mm Hole Size
Red Nylon Radiator Grille
Screw Grommets
Ford # W702438-S300

25 Pcs.



Rivets Black All Aluminum

13517PK 3/16" (4.80mm) Rivet Diameter
9.50mm Flange Size
1.60mm-3.18mm Grip Range
Black All Aluminum
Countersunk Closed End Pop Rivets
Ford # W717984-S417

15 Pcs.



Retainers Shield

18166PK 13/32" (10.50mm) Hole Size
45mm Stem Length
25mm Head Diameter
Black Nylon
Rear Body & Trim Retainers
Ford # W715951-S300

15 Pcs.



Retainers Push Type

17922PK 1/4" (6.50mm) Hole Size
11mm Stem Length
25mm Flange Diameter
Black Nylon
Splash & Heat Shield
Push Type Retainers
Ford # W717823-S300

15 Pcs.



Retainers Moulding

13090PK 23/64" (9mm) Hole Size
14mm Stem Length
12 x 20mm Top Head Size
White Nylon With Sealer
Rocker Panel Moulding Retainers
Ford # W716352-S300

25 Pcs.



Disco Automotive Hardware

Ph: 580-622-3090

Fax: 580-622-3781

discosales@discoautomotive.com

CNP8

06/26/19

COOL NEW PRODUCTS

G.M. Clips & Fasteners

Screws License Plate

12556PK 6.30-1.81 x 20mm
14mm Head Diameter
Duo-Drive Truss Head
Silver Dacromet Finish
License Plate Screws
G.M. # 25732397

50 Pcs.



Nuts Specialty

9335PK 10 x 1.50mm Screw Size
20mm Outside Diameter Flange
Black Finish
Push On Type Retainers
G.M. # 11502759

50 Pcs.



18094PK 6-1.00 Screw Size
.70mm-3.80mm Panel Range
9.25 x 13.75mm Hole Size
Organic Zinc
Rear Bumper Bracket Nuts
G.M. # 11547582

25 Pcs.



Retainers Push Type

13089PK 21/64" (8.50mm) Hole Size
12mm Stem Length
20mm Flange Diameter
Black Nylon
Front Fender & Body Side Liner
Push Type Retainers
G.M. # 11612035

25 Pcs.



Retainers Moulding

12600PK 23/64" (9mm) Hole Size
11mm Stem Length
12 x 20mm Top Head Size
White Nylon With Sealer
Body Side & Trim Moulding Retainer
GM # 11547581

25 Pcs.



18095PK 11mm Stem Length
17 x 20mm Top Head Size
Blue Nylon W/Metal Reinforced
Windshield Pillar, Interior &
Trunk Trim Moulding Retainers
G.M. # 24405740

15 Pcs.



Disco Automotive Hardware

Ph: 580-622-3090

Fax: 580-622-3781

discosales@discoautomotive.com

CNP9

07/03/19

COOL NEW PRODUCTS

G.M. Clips & Fasteners

Rivets Automotive

9176PK 1/4" (6.30mm) Diameter
21/32" Flange Size
5/32"-13/32" Grip Range
White Nylon
Blind Rivets
G.M. # 15506827

25 Pcs.



Retainers Weatherstrip

10974PK 13/64" (5mm) Hole Size
9mm Stem Length
5 x 15mm Head Diameter
Natural Nylon
Weatherstrip Retainers
G.M. # 10283414, 10405030

100 Pcs.



Retainers Push Type

18167PK 5/16" (8mm) Hole Size
15mm Stem Length
20mm Head Diameter
Black Nylon
Front Fender Retainers
G.M. # 11546805

50 Pcs.

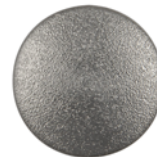

Retainers Door Trim Panel

18217PK 7/16" (11mm) Hole Size
7/16" Stem Length
15/32 x 25/32" Top Head Size
White Nylon With Sealer
Door Trim Panel Retainers
G.M. # 91176726

15 Pcs.



Retainers Moulding

18236PK 23/64" (9mm) Hole Size
20mm Stem Length
9.50 x 20mm Top Head Size
Yellow Nylon With Sealer
Rocker Moulding Clips
G.M. # 15864780, 11569921

10 Pcs.



18119PK 19mm Stem Length
19mm Overall Height
17.50 x 25mm Head Size
Black Finish
Grille Assembly Retainer
G.M. # 11546500

10 Pcs.



Disco Automotive Hardware

Ph: 580-622-3090

Fax: 580-622-3781

discosales@discoautomotive.com

CNP10

07/03/19

COOL NEW PRODUCTS

Toyota Clips & Fasteners

Nuts Specialty

18164PK #12 (5.50mm) Screw Size
17mm Stem Length
20mm Flange Diameter
9mm Hole Size
Black Nylon
Fender Liner Screw Grommets
Toyota # 90189-06236

25 Pcs.



Retainers Phillips Screw

17931PK 17/64" (6.70mm) Hole Size
24mm Stem Length
Red Nylon W/Phillips Drive
Body Side Retainers
Toyota # 90467-09237

25 Pcs.



Retainers Door Trim Panel

17876PK 5/16" (8mm) Hole Size
13mm Stem Length
13mm Top Head Diameter
White Nylon
Door Trim Panel Retainers
Toyota # 67771-06010, 67771-32090

10 Pcs.



Retainers Moulding

17909PK 9/32" (7mm) Hole Size
10mm Stem Length
20mm x 30mm Head Size
Black Nylon With Sealer
Front Fender Moulding Retainers
Toyota # 53857-12010

15 Pcs.



17611PK 32mm Width
39mm Length
Black Nylon
Front Bumper
Cover Retainers
Use With Disco # 11950
Toyota # 53879-30040

5 Pcs.

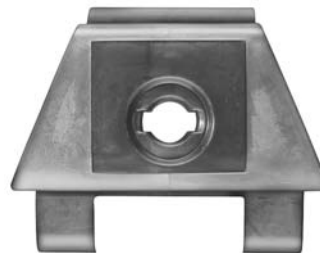

11950PK 10mm Head Diameter
24mm Stem Length
Black Nylon Front Bumper
Cover & Fender Liner Pins
Use With # 11951 & 17611
Lexus # 47749-50090
Toyota # 53879-30040

15 Pcs.



Disco Automotive Hardware

Ph: 580-622-3090

Fax: 580-622-3781

discosales@discoautomotive.com

CNP11

07/03/19

COOL NEW PRODUCTS

Toyota Clips & Fasteners

Retainers Bumper

18163PK 3/8" (9.50mm) Hole Size
14mm Top Rubber Diameter
16.50mm Overall Length
Rubber & Nylon
Rear Door Bumper Retainers
Toyota # 90541-09124

25 Pcs.



Retainers Push Type

18239PK 9/32" (7mm) Hole Size
12mm Stem Length
20mm Head Diameter
Black Nylon Bumper Cover,
Radiator Support & Under Cover
Push Type Retainers
Toyota # 90467-09242

25 Pcs.



18238PK 9/32" (7mm) Hole Size
15mm Stem Length
22 Head Diameter
Black Nylon Cowl Grille
Push Type Retainers
Toyota # 90767-09242

15 Pcs.



Retainers Door Trim Panel

18218PK 3/8" (9.50mm) Hole Size
15mm Stem Length
13mm Top Head Diameter
White Nylon With Sealer
Door Trim Panel Retainers
Toyota # 90467-09206

15 Pcs.



Retainers Moulding

9340PK 21mm Overall Height
7.50mm Width
Pink Nylon Door Trim,
Instrument Panel, Rear Deck &
Roof Garnish Trim Moulding Retainers
Toyota # 90467-12080

25 Pcs.



18231PK 17 x 22mm Hole Size
10mm Stem Length
28 x 37mm Head Size
Black Nylon Rocker & Quarter
Moulding Retainers
Toyota # 76924-12030

25 Pcs.



Disco Automotive Hardware

Ph: 580-622-3090

Fax: 580-622-3781

discosales@discoautomotive.com



CNP12



07/10/19

COOL NEW PRODUCTS



Mazda Clips & Fasteners

Retainers Push Type



18234PK	5/16" (8mm) Hole Size 13mm Stem Length 20mm Flange Diameter Black Nylon Bumper, Engine Cover, Fender & Quarter Panel Push Type Retainers Mazda # B45A-56-146A Toyota # 90118-WB048	25 Pcs.		
----------------	---	----------------	--	---



18109PK	5/16" (8mm) Hole Size 14mm Stem Length 20mm Head Diameter Black Nylon Bumper Cover & Fender Liner Push Type Retainers Mazda # BGV4-56-145	25 Pcs.		
----------------	---	----------------	--	---



Retainers Grille

18107PK	9mm Stem Width 13mm Stem Length 9 x 22mm Head Size Black Nylon Grille Emblem Retainers Mazda # G46L-50-EB1	25 Pcs.		
----------------	---	----------------	--	---

Retainers Moulding

18112PK	25/64" (10mm) Hole Size 14mm Stem Length 14mm Top Head Diameter Gray Nylon Wheel Arch Moulding Retainers Mazda # KD53-51-W24	25 Pcs.		
----------------	---	----------------	--	---

18114PK	25/64" (10mm) Hole Size 14mm Stem Length 15mm Top Head Diameter White Nylon With Sealer Wheel Opening Moulding Retainers Mazda # KD51-51-W24	15 Pcs.		
----------------	---	----------------	--	---

18104PK	7/16" (11mm) Hole Size 9mm Stem Length 10 x 15mm Top Head Size Gray Nylon W/Sealer Stone Guard Moulding Retainers Mazda # KD53-51-SJ3A	25 Pcs.		
----------------	---	----------------	--	---

Disco Automotive Hardware

Ph: 580-622-3090

Fax: 580-622-3781

discosales@discoautomotive.com

CNP13

07/10/19

COOL NEW PRODUCTS

Screws

Screws Phillips Trim

12904PK 4.8-1.61 x 16mm
11mm Head Diameter
Black Finish
Phillips Trim Screws

100 Pcs.



Electrical Products

Cable Ties

12354PK 5" Length .14" Width
1.30" Max Bundle Diameter
40lbs Tensile Strength
Black Nylon
Cable Ties

100 Pcs.



9655PK 11" Length .189" Width
3.20" Max Bundle Diameter
50 lbs. Tensile Strength
Black Nylon
#10 Screw Mounting Cable Ties

100 Pcs.



Not Actual Size



G.M. Clips & Fasteners

Nuts Specialty

13423PK 6-1.00 Thread Size
11mm Overall Height
Zinc Organic
Radiator Grille & Front
End Panel Nuts
G.M. # 11518937

10 Pcs.



17945PK #10 (4.80mm) Screw Size
11mm Stem Length
9.50mm Head Diameter
Natural Nylon
Lower Door & Handle
Interior Trim Grommets
GM # 90230846, 94515248

25 Pcs.



Retainers Moulding

18165PK 12mm Stem Length
17 x 20mm Top Head Size
Black Nylon W/Metal Reinforced
Windshield Pillar & Interior
Moulding Retainers
G.M. # 24405739

15 Pcs.



Disco Automotive Hardware

Ph: 580-622-3090

Fax: 580-622-3781

discosales@discoautomotive.com

CNP14

12/11/19

COOL NEW PRODUCTS

Chrysler Clips & Fasteners

Nuts Specialty

12023PK 5 -0.80mm Screw Size
11mm Outside Diameter Flange
Zinc Finish
Push On Type Retainers
Chrysler # 6100839

100 Pcs.



Retainers Push Type

18221PK 1/4" (6.30mm) Hole Size
7/8" Stem Length
11/16" Diameter Flange
Black Nylon Body
Push Type Retainers
Chrysler # 34202672
Ford # N803362-S
G.M. # 20510029

25 Pcs.



Retainer Door Trim Panel

17942PK 7/16" (11mm) Hole Size
19mm Stem Length
16mm Top Head Diameter
White Nylon
Door Trim Panel Retainer
Chrysler # 55116997AB, 55116997AA

25 Pcs.



Retainers Grille

11912PK 1/2" Width
23/32" Height
Black Finish
Grille To Fascia Retainers
Chrysler # 4676356

15 Pcs.



Retainers Moulding

17943PK 3/8" (9mm) Hole Size
13mm Stem Length
11 x 12mm Top Head Size
White Nylon With Sealer
Body Moulding Retainer
Citroen & Peugeot # 856543
Chrysler # 68093998-AA
Fiat # 71728806

25 Pcs.



18251PK 23/64" (9mm) Hole Size
15mm Stem Length
14 x 20mm Top Head Size
Black Nylon With Sealer
Rocker Moulding Retainer
Chrysler # 68283229AA

10 Pcs.



Disco Automotive Hardware

Ph: 580-622-3090

Fax: 580-622-3781

discosales@discoautomotive.com





CNP15

07/17/19



COOL NEW PRODUCTS

Honda Clips & Fasteners



Nuts Specialty

18229PK	17mm Stem Length 22mm Overall Length 13mm Top Head Diameter Black Nylon Engine Cover Retainers Honda # 91547-TZ5-A02	50 Pcs.		
18230PK	13.50 x 7.60mm Hole Size 16mm Stem Length 22 x 14mm Head Size Dark Gray Engine Cover Grommets Honda # 91548-TZ5-A02	25 Pcs.		

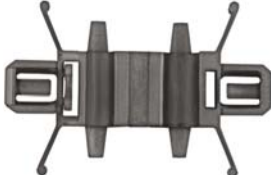

Retainers Wheel Well

18110PK	9/64" (3.50mm) Hole Size 16mm Stem Length 18mm Head Diameter Black Nylon Inner Fender Wheel Well Retainers Honda # 91512-SED-003	25 Pcs.		
----------------	---	----------------	--	---

Clips Hood Release Cable

18106PK	9/32" (7mm) Hole Size 6.50mm Stem Length Holds 5mm Diameter Cable Black Nylon Hood Release Cable Clip Honda # 91504-SDA-003	25 Pcs.		
----------------	--	----------------	--	---

Retainers Moulding

17940PK	13/32" (10mm) Hole Size 9mm Stem Length 10 x 12mm Head Size White Nylon With Sealer Lower Door Moulding Retainer Honda # 75316-TP6-A01	25 Pcs.		
----------------	---	----------------	--	---

Disco Automotive Hardware

Ph: 580-622-3090

Fax: 580-622-3781

discosales@discoautomotive.com

CNP16

07/17/19

COOL NEW PRODUCTS

Hyundai Clips & Fasteners

Nuts Specialty

17932PK 14mm Hex Size
30mm Flange Diameter
Black Nylon
Wheel Well Liner &
Splash Shield Nuts
Hyundai # 84145-26000

15 Pcs.



17939PK #6 (3.5mm) Screw Size
12mm Stem Length
8 x 10mm Head Size
White Nylon
Bumper Grommet
Hyundai # 86518-3M000

25 Pcs.



Retainers Hood Prop

18118PK 8mm Rod Size
14mm Hole Size
24mm Length 20mm Width
Black Nylon
Hood Prop Rod Clips
Hyundai # 81174-2L000

15 Pcs.



18117PK Holds 8mm Rod
9mm Stem Length
20 x 20mm Bottom Base Size
Black Nylon
Hood Prop Retainers
Hyundai # 81174-21000,
81174-11011, 81174-21010

15 Pcs.



Retainers Weatherstrip

18100PK 13/64" (5mm) Hole Size
6mm Stem Length
5 x 13mm Head Size
Red Nylon
Weatherstrip Retainers
Hyundai # 82133-37000

50 Pcs.



17933PK 13/64" (5mm) Hole Size
11mm Stem Length
5 x 15mm Top Head Size
White Nylon
Door Weatherstrip Retainers
Hyundai # 82132-27100

25 Pcs.



17937PK 1/4" (6mm) Hole Size
8mm Stem Length
5 x 15mm Head Size
Red Nylon
Weatherstrip Retainers
Hyundai # 87756-2W000

100 Pcs.



Disco Automotive Hardware

Ph: 580-622-3090

Fax: 580-622-3781

discosales@discoautomotive.com

CNP17

07/17/19

COOL NEW PRODUCTS

Hyundai Clips & Fasteners

Retainers Moulding

17938PK 1/2" (12mm) Hole Size
10mm Stem Length
14 x 18mm Head Size
Blue Nylon With Sealer
Door Moulding Retainers
Hyundai # 87756-D3000

25 Pcs.



18116PK 25/64" (10mm) Hole Size
9mm Stem Length
13 x 16mm Head Size
Pink Nylon With Sealer
Side Garnish Moulding Retainers
Hyundai # 87756-2J000

15 Pcs.



17935PK 1/2" (12mm) Hole Size
17mm Stem Length
12 x 12mm Top Head Size
Yellow Nylon With Sealer
Moulding Retainers
Hyundai # 87759-3V000

25 Pcs.



Nissan Clips & Fasteners

Screw Grommets

18102PK #12 (5.50mm) Screw Size
9mm Stem Length
10mm Top Head Size
Yellow Nylon Front & Rear Bumper
Screw Grommets
Nissan # 85099-1MA0A

25 Pcs.



Retainers Moulding

18101PK 5/16" (8mm) Hole Size
12mm Stem Length
10 x 17mm Top Head Size
Green Nylon With Sealer
Rocker Panel Moulding Retainers
Nissan 76882-1KA1A

25 Pcs.



18242PK 23/64" (9mm) Hole Size
12mm Stem Length
14 x 21.50mm Top Head Size
Black Nylon
Rocker Panel Moulding Retainers
Nissan # N/A

25 Pcs.



Disco Automotive Hardware

Ph: 580-622-3090

Fax: 580-622-3781

discosales@discoautomotive.com

CNP18

07/24/19

COOL NEW PRODUCTS

BMW Clips & Fasteners

Screws Sems®

13096PK 4.8-1.61 x 16mm
8mm Indented Hex Head
18mm Outside Diameter Loose Washer
Black Zinc
Sems® Screws
BMW # 17-14-7-129-160

50 Pcs.



Nuts Specialty

18099PK 23/64" (9mm) Hole Size
9mm Overall Height
30mm Head Diameter
Gray Nylon
Sound Insulation Grommet
BMW # 51-48-8-126-849

25 Pcs.



Rivets Trim Cover

18243PK 15/64" (6mm) Diameter
20mm Flange Size
1.50mm - 10mm Grip Range
White Nylon Wheel Arch
Trim Cover Rivets
BMW # 07147391324

25 Pcs.



18244PK 15/64" (6mm) Diameter
20mm Flange Size
2.50mm - 10.75 Grip Range
Black Nylon Wheel Arch
Trim Cover Rivets
BMW # 07147293278

25 Pcs.



Retainers Shield

18115PK 5/32" (4mm) Hole Size
23mm Stem Length
24mm Head Diameter
Black Nylon T27 Drive
Side Shield & Trim Retainers
BMW # 07-14-7-296-886

25 Pcs.



18103PK 19/64" (7.50mm) Hole Size
25mm Stem Length
14mm Head Diameter
Black Nylon Seat Back Panel
Shield Retainer
BMW # 52-20-1-964-201

25 Pcs.



Disco Automotive Hardware

Ph: 580-622-3090

Fax: 580-622-3781

discosales@discoautomotive.com

CNP19

07/24/19

COOL NEW PRODUCTS

Mazda Clips & Fasteners

Clips Hood Release Cable

18108PK 15/64" (6mm) Hole Size
9mm Stem Length
Holds 5mm Diameter Cable
Black Nylon
Hood Release Cable Clips
Mazda # D001-56-731

25 Pcs.



Retainers Moulding

18113PK 25/64" (10mm) Hole Size
12mm Stem Length
13 x 17mm Top Head Size
Green Nylon With Sealer
Rocker Panel Moulding Retainers
Mazda # D10E-51-SJ3

15 Pcs.



Toyota Clips & Fasteners

Retainers Moulding

17944PK 25/64" (10mm) Hole Size
19mm Stem Length
10.30 x 16.50mm Top Head Size
Yellow Nylon With Sealer
Rocker Moulding Retainers
Toyota # 75494-42010, 75395-42020

25 Pcs.



Volvo Clips & Fasteners

Retainers Moulding

18232PK 5/16" (8mm) Hole Size
18mm Stem Length
13 x 22mm Top Head Size
White Nylon
Rocker Panel Moulding Retainers
Volvo # 31214496

15 Pcs.



Retainers Hood Insulation

18233PK 15mm Stem Length
25 x 30mm Head Size
Black Nylon
Hood Insulation Retainers
Volvo # 9182822

15 Pcs.



Disco Automotive Hardware

Ph: 580-622-3090

Fax: 580-622-3781

discosales@discoautomotive.com

CNP20

07/24/19

COOL NEW PRODUCTS

Oil Drain Hardware

Gaskets Oil Drain Plug

18228PK 13mm Inside Diameter
22mm Outside Diameter
2.40mm Thickness
Black Rubber
Oil Drain Gaskets
Ford # F5TZ-6734-BA

10 Pcs.



18224PK 18mm Inside Diameter
24mm Outside Diameter
2.50mm Thickness
Steel Crushable
Oil Drain Gaskets
Toyota # 12157-10010

10 Pcs.



Plugs Oil Drain

18225PK 24-1.50 x 11mm
10mm Internal Hex Drive
36mm Top Head Diameter
Black Plastic With Rubber Seal
Oil Drain Plugs
BMW # 11-13-7-605-018

1 Pcs.



18227PK 13/16" Head Diameter
1 13/16" Overall Length
3/8" Square Drive
Yellow Plastic W/ O-Ring Seal
Oil Drain Plug
Ford # BC3Z-6730-A

1 Pcs.



Not Actual Size

18226PK 23mm Head Diameter
20mm Overall Length
Slot For Screw Driver
Black Plastic With O-Ring Seal
Oil Drain Plugs
Volkswagen # 06L-103-801

1 Pcs.



Disco Automotive Hardware

Ph: 580-622-3090

Fax: 580-622-3781

discosales@discoautomotive.com

CNP21

08/21/19

COOL NEW PRODUCTS

Assortments

Assortment Bolts & Nuts Class 10.9 Flange All Coarse Threads



3213PK



8-1.25 x 25mm

Class 10.9 Hex Flange Bolts

Part #	Class	Diameter	Length	Cabinet	Labels	Total Pcs.	Qty.	
8713A	Metric 10.9	6 to 10mm	12 to 90mm	# 80341 Gray Bin	Set #17822	915	1 Pc.	NEW
8713RA	Metric 10.9	6 to 10mm	12 to 90mm	# 80343 Red Bin	Set #17822	915		DISCONTINUED
8713BA	Metric 10.9	6 to 10mm	12 to 90mm	# 80365 Black Bin	Set #17822	915		DISCONTINUED

8-1.25 x 25mm

Class 10.9 Hex Flange Bolts

Part #	Class	Diameter	Length	Cabinet	Labels	Total Pcs.	Qty.	
8713B	Metric 10.9	6 to 10mm	12 to 90mm	# 80341 Gray Bin	Set #17831	915	1 Pc.	NEW
8713RB	Metric 10.9	6 to 10mm	12 to 90mm	# 80343 Red Bin	Set #17831	915		DISCONTINUED
8713BB	Metric 10.9	6 to 10mm	12 to 90mm	# 80365 Black Bin	Set #17831	915		DISCONTINUED

Disco Automotive Hardware

Ph: 580-622-3090

Fax: 580-622-3781

discosales@discoautomotive.com

CNP22

08/21/19

COOL NEW PRODUCTS

Specialty Nuts

Nuts Washer Lock

11865PK 1/4"-20 Screw Size
7/16" Hex Size
19/32" Flange Diameter
Zinc Finish
Washer Lock Nuts

100 Pcs.



Ford Clips & Fasteners

Nuts Specialty

18145PK 3/8" (9.50mm) Hole Size
21mm Stem Length
Natural Rubber
Rear Bumper Cover Grommets
Use With # 17832

25 Pcs.



18255PK 3/8" (9.50mm) Hole Size
21mm Stem Length
Black Rubber
Rear Bumper Cover Grommets
Use With # 17832
Ford # W708045-S300

25 Pcs.



Retainers Shield

17832PK 9/32" (7mm) Hole Size
25mm Stem Length
21mm Head Diameter
Black Nylon
Rear Bumper Cover Retainers
Use With # 18145
Ford # W708035-S300

25 Pcs.



Retainers Moulding

15304PK 23/64" (9mm) Hole Size
16mm Stem Length
14 x 18mm Top Head Size
White Nylon With Sealer
Rocker Moulding Clips
Ford N/A

10 Pcs.



BMW Clips & Fasteners

Retainers Moulding

13228PK 5/16" (8mm) Hole Size
8mm Stem Length
13mm Top Head Diameter
Black Nylon Rear Quarter
Wheel Opening Moulding Clips
BMW # 07-13-0-702-516

25 Pcs.



Disco Automotive Hardware

Ph: 580-622-3090

Fax: 580-622-3781

discosales@discoautomotive.com

CNP23

08/28/19

COOL NEW PRODUCTS

Service Equipment

Storage Bins, 72 Hole



80364



80345



80366

Part #	Width	Depth	Height	Finish	Use With Stand	Qty.
80364	35 1/4"	11 7/8"	42"	Gray	#80353 or #80356	DISCONTINUED
80345	35 1/4"	11 7/8"	42"	Red	#80344	DISCONTINUED
80366	35 1/4"	11 7/8"	42"	Black	#80367	DISCONTINUED

Assortments

Assortment Honda Bumper Retainer

8216 Contains 6 Different Sizes
89 Total Pieces
Black Nylon
Honda Cars
Bumper Retainer Assortment

Sold
Each



Disco Automotive Hardware

Ph: 580-622-3090

Fax: 580-622-3781

discosales@discoautomotive.com

CNP24

08/28/19

COOL NEW PRODUCTS

Kia Clips & Fasteners

Retainers Moulding

17914PK 15/32" (12mm) Hole Size
10mm Stem Length
10 x 12mm Top Head Size
Red Nylon With Sealer Fender,
Rocker & Wheel Moulding Retainers
Kia # 87756-C5000

25 Pcs.



Mitsubishi Clips & Fasteners

Retainers Moulding

18111PK 9/32" (7mm) Hole Size
10mm Stem Length
12mm Top Head Diameter
White Nylon
Moulding Retainers
Mitsubishi # MU000573

25 Pcs.



SPR Extraction Tool

18219 Removes 3.35mm and 5.30mm Diameter
Self Piercing Rivets
Heavy Duty
SPR Extraction Tool
Use with a 3/4" Socket on a 1/2" Impact Gun

1 Pc.



SPR Insertion Tool

18220 Installs 3.35mm and 5.30mm Diameter
Self Piercing Rivets
Heavy Duty
SPR Insertion Tool
Use with a 3/4" Socket on a 1/2" Impact Gun

1 Pc.



Disco Automotive Hardware

Ph: 580-622-3090

Fax: 580-622-3781

discosales@discoautomotive.com

CNP25

08/28/19

COOL NEW PRODUCTS

8813



Black Nylon Tie Strap Assortment

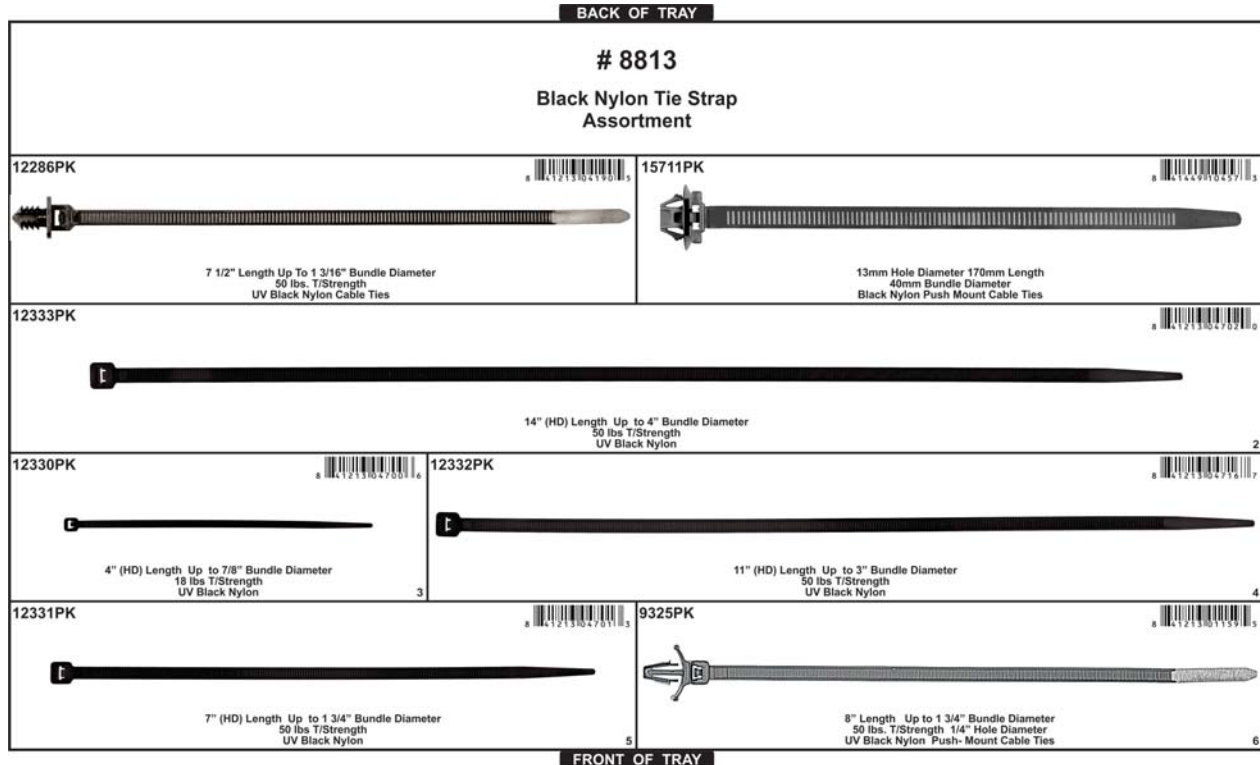

Contains 7 Different Sizes
475 Total Pieces
Sizes from 4" to 14"
Black Nylon
Tie Strap Assortment



Part #	Tray Type	Material	Tray #	Tray Color	Lid Color	Label Type	Clear Pocket	Qty.	
8813	Adjustable	Plastic	80132	Gray	Gray	Adhesive	No	1 Pc.	NEW
8813BCP	Adjustable	Plastic	80156BC	Dark Blue	Clear	Paper	Yes	1 Pc.	NEW
8813GCP	Adjustable	Plastic	80132GC	Gray	Clear	Paper	Yes	1 Pc.	NEW
8813RCP	Adjustable	Plastic	80153RC	Red	Clear	Paper	Yes	1 Pc.	NEW
8813YCP	Adjustable	Plastic	80132YC	Yellow	Clear	Paper	Yes	1 Pc.	NEW

Disco Automotive Hardware

Ph: 580-622-3090

Fax: 580-622-3781

discosales@discoautomotive.com

CNP26

09/04/19

COOL NEW PRODUCTS

Honda Clips & Fasteners

Retainers Push Type

18250PK 5/16" (8mm) Hole Size
11.50mm Stem Length
10 x 10mm Top Head Size
Black Nylon With Sealer
Wheel Arch Protective
Push Type Retainers
Honda # 91513-T0A-A01

25 Pcs.



Retainers Moulding

18249PK 20mm Width
38mm Length
Green Nylon
Door Belt Moulding Clips
Honda # 91503-SWA-A01

25 Pcs.



Hyundai Clips & Fasteners

Retainers Moulding

17934PK 7/16" (11mm) Hole Size
14mm Stem Length
17 x 25mm Head Size
White Nylon With Sealer
Rocker Moulding Retainers
Hyundai # 87758-2S000

25 Pcs.



17936PK 1/2" (12mm) Hole Size
9mm Stem Length
10 x 13mm Head Size
White Nylon With Sealer
Rocker Moulding Retainers
Hyundai # 87758-38000

50 Pcs.



Mazda Clips & Fasteners

Nuts Specialty

18105PK #10 (4.80mm) Screw Size
Up to 1mm Panel Range
11mm Center of Hole to Edge
Gray Nylon Front Bumper
"U" Type Nuts
Mazda # C274-50-133

25 Pcs.



Disco Automotive Hardware

Ph: 580-622-3090

Fax: 580-622-3781

discosales@discoautomotive.com

CNP27

09/04/19

COOL NEW PRODUCTS

Electrical Products

Connectors Self Stripping

17923PK 22-14 Gauge Wire
Connects 2 or 3
Unstripped Wires
With Sealant
Self Stripping Connectors
For use to 600V maximum

10 Pcs.



G.M. Clips & Fasteners

Screws Pan Head Metric Torx®

13421PK 4.2-1.41 x 20mm
9.50mm Pan Head
17mm O.D. Loose Washer
Black Zinc Metric Torx®
With Dog Point Tap Screws
G.M. # 11570637

50 Pcs.



Screws Pozi-Drive Sems® Tapping

17609PK 4.2-1.41 x 25mm
17mm Outside Diameter Loose Washer
Black Zinc Pozi-Drive
Round Washer Head
Sems® Tapping Screws
G.M. # 11609762

50 Pcs.



Retainers Weatherstrip

18247PK 9/64" (3.50mm) Hole Size
7/16" Stem Length
13/32" Flange Diameter
Black Nylon
Weatherstrip Retainers
G.M. # 4801268

100 Pcs.



Ford Clips & Fasteners

Screws Pan Head Sems®

17930PK 5-2.2 x 20mm
20mm Outside Diameter Loose Washer
Black Finish T30 Torx® Drive
Pan Head Sems® Screws
Use With 17833 & 17908
Ford # W702413-S450B, W702413-S307

15 Pcs.



Disco Automotive Hardware

Ph: 580-622-3090

Fax: 580-622-3781

discosales@discoautomotive.com

CNP28

09/11/19

COOL NEW PRODUCTS

Windshield Retainers

Blocks Windshield Setting

13237PK 51mm Overall Length
Adhesive Backing
Windshield Glass
Setting Block
G.M. # 15061964

10 Pcs.



Toyota Clips & Fasteners

Retainers Moulding

18252PK 7/8" (22mm) Hole Size
11mm Stem Length
38mm Head Diameter
Black Nylon With Sealer
Rocker Moulding Retainers
Toyota # 90467-22014

10 Pcs.



18253PK 7/8" (22mm) Hole Size
35mm Stem Length
47mm Head Diameter
Black Nylon With Sealer
Rocker Moulding Retainers
Toyota # 90467-22015

10 Pcs.



Not Actual Size

Electrical Products

Washers Terminal Protector

15837PK For Post & Side Terminals
Fights Battery Corrosion
Prolongs Battery Life
Contains 1 Red & 1 Black
Terminal Protector Washers

1 Set



Not Actual Size

Disco Automotive Hardware

Ph: 580-622-3090

Fax: 580-622-3781

discosales@discoautomotive.com

CNP29

10/02/19

COOL NEW PRODUCTS

Screws

Screws Sheet Metal

482PK 6 x 1/4"
Phillips Pan Head
Bright Zinc Finish
Sheet Metal Screws

100 Pcs.



Screws Phillips Pozi Drive

13114PK 4.2-1.41 x 10mm
Phillips Pozi Drive
11mm Outside Diameter Washer Head
Black Oxide
Phillips Pozi Drive Screws
G.M. # 11501903

100 Pcs.



Oil Drain Hardware

Plugs Steel Pipe

17748PK 1/2"-14
Square Drive
Zinc Finish
Steel Pipe Plugs

10 Pcs.



Electrical Products

Bulb Halogen Headlight

7H16 Clear
12 Volt 19 Watt
Base Type: PGJ19-3
Bulb Shape: T-3 1/2
Halogen Headlight Bulb

1 Pc.

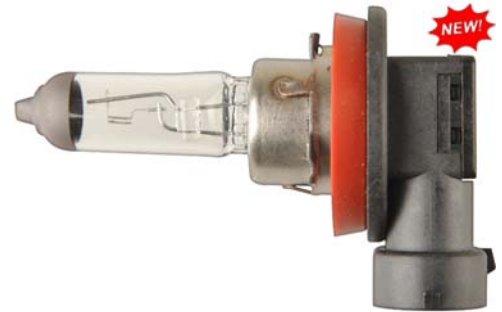

Shield Retainers

Retainers Weatherstrip

18246PK 13/32" (10.60mm) Hole Size
10mm Stem Length
12 x 15mm Top Head Size
White Nylon Door
Weatherstrip Retainers

15 Pcs.



Disco Automotive Hardware

Ph: 580-622-3090

Fax: 580-622-3781

discosales@discoautomotive.com

CNP30

10/02/19

COOL NEW PRODUCTS

Standard Fasteners

Nuts Hex USS Nylon Lock Insert Bright Zinc Finish



	Size	Hex Size	Type	Finish	Qty.
12767PK	1/4"-20	7/16"	USS	Bright Zinc	100 Pcs.
12768PK	5/16"-18	1/2"	USS	Bright Zinc	100 Pcs.
12769PK	3/8"-16	9/16"	USS	Bright Zinc	50 Pcs.
12770PK	7/16"-14	5/8"	USS	Bright Zinc	25 Pcs.
12771PK	1/2"-13	3/4"	USS	Bright Zinc	25 Pcs.
12772PK	9/16"-12	7/8"	USS	Bright Zinc	25 Pcs. NEW
12773PK	5/8"-11	15/16"	USS	Bright Zinc	25 Pcs. NEW
12774PK	3/4"-10	1 1/8"	USS	Bright Zinc	25 Pcs. NEW

Nuts Hex SAE Nylon Lock Insert Bright Zinc Finish



Part #	Size	Hex Size	Type	Finish	Qty.
12777PK	1/4"-28	7/16"	SAE	Bright Zinc	100 Pcs.
12778PK	5/16"-24	1/2"	SAE	Bright Zinc	100 Pcs.
12779PK	3/8"-24	9/16"	SAE	Bright Zinc	50 Pcs.
12780PK	7/16"-20	5/8"	SAE	Bright Zinc	25 Pcs.
12781PK	1/2"-20	3/4"	SAE	Bright Zinc	25 Pcs.
12782PK	9/16"-18	7/8"	SAE	Bright Zinc	25 Pcs. NEW
12783PK	5/8"-18	15/16"	SAE	Bright Zinc	25 Pcs.
12784PK	3/4"-16	1 1/8"	SAE	Bright Zinc	25 Pcs. NEW

Ford Clips & Fasteners

Screws Hex Head Sems®

12034PK 6.3-1.81 x 16mm
16mm Outside Diameter Washer
8mm Hex Head
Black Finish
Hex Head Sems® Screws
Ford # N800312-S2

50 Pcs.



Disco Automotive Hardware

Ph: 580-622-3090

Fax: 580-622-3781

discosales@discoautomotive.com

CNP31

10/02/19

COOL NEW PRODUCTS

TRIM-KUT® DISCS NEW!

This is the exclusive manufacturer in the world for Trim-Kut. Trim-Kut is a revolutionary abrasive disc designed to grind and finish a wide variety of materials faster and cooler than any other abrasive disc available today. The patented process of fusing premium abrasive grains to a durable polymer backing results in a highly versatile grinding tool that requires no backing pad. Trim-Kut is readily trimmable to either renew the cutting surface or reduce the diameter. Trim-Kut discs are available in 3" and 5" for use on a drill or die grinder and 4.5" for use on an angle grinder. These durable discs can be used for grinding or sanding. Another major feature is that the discs can be trimmed. When the outside edge is loaded to the point where it is not grinding effectively, trim it off.

TRIM KUT® DISC



15826PK

Mandrel tool comes included in each box of Trim Kut Discs & also sold in packages of 2.

Revolutionary trim down feature eliminates need for small disc for hard to get at areas.

Trim down feature reduces diameter of disc exposing a new grinding surface at operating R.P.M.

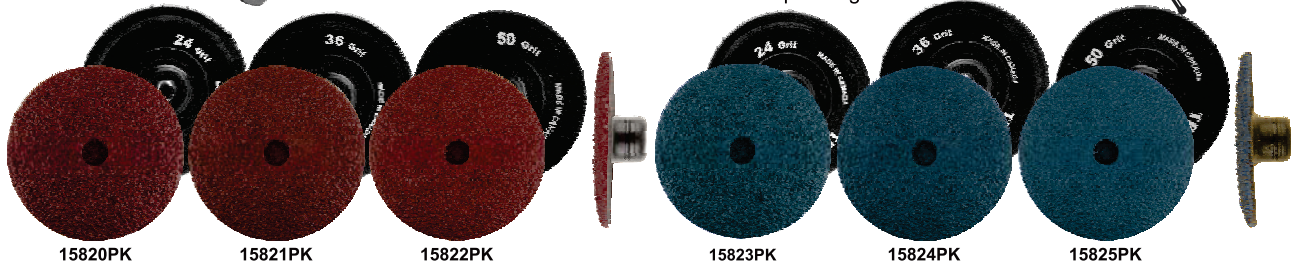
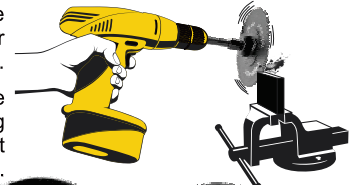

15820PK

15821PK

15822PK

15823PK

15824PK

15825PK

Part #	Grit	RPM	Color	Size	Contains	Qty.
15820PK	24	21,000 Max	Aluminum Oxide Maroon	3"	One 1/4" Mandrel	25 Discs
15821PK	36	21,000 Max	Aluminum Oxide Maroon	3"	One 1/4" Mandrel	25 Discs
15822PK	50	21,000 Max	Aluminum Oxide Maroon	3"	One 1/4" Mandrel	25 Discs
15823PK	24	21,000 Max	Zirconia Blue	3"	One 1/4" Mandrel	25 Discs
15824PK	36	21,000 Max	Zirconia Blue	3"	One 1/4" Mandrel	25 Discs
15825PK	50	21,000 Max	Zirconia Blue	3"	One 1/4" Mandrel	25 Discs

ABRASIVE HAND PADS NEW!



Green

15835PK
10 per pack
Grit Industrial



Maroon

15836PK
10 per pack
Grit Medium



Gray

15866PK
10 per pack
Grit Ultra Fine

6" x 9"

Non-Woven Pads
Impregnated with Resin

Used to prepare surfaces that contain rust or just general cleaning

Disco Automotive Hardware

Ph: 580-622-3090

Fax: 580-622-3781

discosales@discoautomotive.com

CNP32

10/30/19

COOL NEW PRODUCTS

Rivets

Rivets Multi Grip Pop Aluminum & Steel

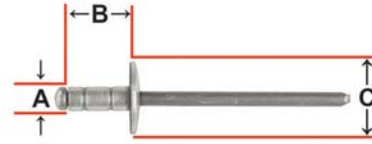
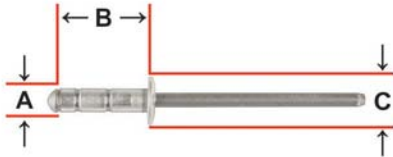

The Multi-Grip rivet will serve in applications where solid, soft materials and thicknesses normally require several rivet sizes. Oversize, irregular or misaligned holes are automatically compensated for by self adjusting hole-filling capability. The mandrel head is retained in the rivet body, forming a tight, weather resistant seal.

Part #	A-Rivet Diameter	Hole Size	Grip Range	B-Rivet Length	C-Flange Diameter	Flange Style	Material Type	Qty.	
17051PK	1/8"	.129 - .142"	5/32 - 5/16"	15/32"	1/4"	Dome	Alum/Steel	100 Pcs.	NEW
17052PK	1/8"	.129 - .142"	5/32 - 5/16"	15/32"	3/8"	Large Flange	Alum/Steel	100 Pcs.	NEW
17053PK	1/8"	.129 - .142"	1/4 - 7/16"	39/64"	1/4"	Dome	Alum/Steel	100 Pcs.	NEW
17054PK	5/32"	.160 - .173"	3/64 - 1/4"	13/32"	5/16"	Dome	Alum/Steel	100 Pcs.	NEW
17057PK	3/16"	.192 - .205"	1/16 - 1/4"	7/16"	3/8"	Dome	Alum/Steel	50 Pcs.	NEW
17058PK	3/16"	.192 - .205"	1/16 - 1/4"	7/16"	5/8"	Large Flange	Alum/Steel	50 Pcs.	NEW
17059PK	3/16"	.192 - .205"	3/16 - 3/8"	5/8"	3/8"	Dome	Alum/Steel	50 Pcs.	NEW
17060PK	3/16"	.192 - .205"	1/4 - 1/2"	47/64"	3/8"	Dome	Alum/Steel	50 Pcs.	NEW
17061PK	3/16"	.192 - .205"	1/4 - 1/2"	47/64"	5/8"	Large Flange	Alum/Steel	50 Pcs.	NEW
17062PK	3/16"	.192 - .205"	7/16 - 3/4"	1 1/16"	3/8"	Dome	Alum/Steel	50 Pcs.	NEW
17063PK	1/4"	.261 - .275"	5/64 - 11/32"	39/64"	1/2"	Dome	Alum/Steel	25 Pcs.	NEW

Nissan Clips & Fasteners

Screw Grommets

9688PK #8 (4.20mm) Screw Size
 10mm Stem Length
 16mm Head Diameter
 9mm Hole Size
 Natural Nylon
 Bumper, Fender & Light
 Screw Grommets
 Nissan # 01281-00831

25 Pcs.



G.M. Clips & Fasteners

Grommets Tail Light

15816PK 25/64" (10mm) Hole Size
 15mm Stem Length
 18mm Head Diameter
 White Nylon With Sealer
 Tail Light Grommets
 G.M. # 22884291

10 Pcs.



Disco Automotive Hardware

Ph: 580-622-3090

Fax: 580-622-3781

discosales@discoautomotive.com

CNP33

11/20/19

COOL NEW PRODUCTS

G.M. Clips & Fasteners

Screws Tek®

12816PK 4.2-1.41 x 16mm
7mm Indented Hex Head
12mm Outside Diameter Loose Washer
Black Finish
Tek® Screws
G.M. # 11503578, 11503785

50 Pcs.



Screws Sheet Metal

12669PK 4.2-1.41 x 20mm
7mm Indented Hex Head
20mm Outside Diameter Loose Washer
Black Finish
Sheet Metal Screws
Chrysler # 6506161-AA
G.M. # 14090382

50 Pcs.



Screws Hex Head Sems®

12035PK 6.3-1.81 x 30mm
10mm Indented Hex Head
17mm Outside Diameter Loose Washer
Black Finish
Hex Head Sems® Screws
G.M. # 11500997

50 Pcs.



10457PK 6.3-1.81 x 30mm
10mm Indented Hex Head
24mm Outside Diameter Loose Washer
Black Finish
Hex Head Sems® Screws
G.M. # 11504981

50 Pcs.



Nuts Extruded "U"

11043PK #8 (4.20-1.41mm) Screw Size
.65mm - 3.80mm Panel Range
15mm Center of Hole To Edge
Zinc Organic Prevailing Torque
Extruded "U" Nuts
G.M. # 11515638

25 Pcs.



Nuts Bracket Retainer

15864PK #8 (4.20-1.41mm) Screw Size
1.40 - 5mm Panel Range
10.90 x 13mm Hole Size
Green Metallic Finish
Bracket Retainer Nuts
G.M. # 11548673

15 Pcs.



Disco Automotive Hardware

Ph: 580-622-3090

Fax: 580-622-3781

discosales@discoautomotive.com

CNP34

11/20/19

COOL NEW PRODUCTS

Chrysler Clips & Fasteners

Screws Phillips Flat Top Trim Bright Zinc

11415PK 10 x 1/2"
Phillips Flat Top
15/32" Outside Diameter Washer Head
Bright Zinc Finish
Trim Screws
Chrysler # 9428273

100 Pcs.



15682PK 10 x 3/4"
Phillips Flat Top
15/32" Outside Diameter Washer Head
Bright Zinc Finish
Trim Screws
Chrysler # 9427977

50 Pcs.



Ford Clips & Fasteners

Retainers Weatherstrip

12067PK 13/64" (5mm) Hole Size
10mm Stem Length
5 x 15mm Head Diameter
Natural Nylon
Weatherstrip Retainers
Ford # N806340-S

100 Pcs.



Retainers Fender Liner

11250PK 1/4" (6.30mm) Hole Size
28mm Stem Length
26mm Head Diameter
Black Nylon
Fender Liner Retainers
Ford # W706635-SSW

50 Pcs.



Retainers Door Trim Panel

10448PK 5/16" (7.90mm) Hole Size
1 1/2" Stem Length
1" Head Diameter
Gray Nylon
Trim Panel Retainers
Ford # N806344-S

25 Pcs.

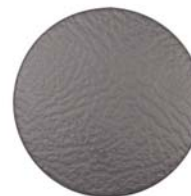

Subaru Clips & Fasteners

Retainers Push Type

15337PK 7/16" (11mm) Hole Size
16mm Stem Length
25mm Head Diameter
Black Nylon With Sealer
Rocker, Pillar, Floor & Trim
Push Type Retainers
Subaru # 90914-0002







25 Pcs.



COOL NEW PRODUCTS

Hyundai Clips & Fasteners

Retainers Door Trim Panel



15827PK	16mm Overall Height 11mm Width Black Nylon Interior Trim Retainers Hyundai # 85858-3S000	50 Pcs.		
15828PK	19mm Overall Height 15mm Width Black Nylon Interior Trim Retainers Hyundai # 85859-3S100	50 Pcs.		
15876PK	21/64" (8.50mm) Hole Size 10mm Stem Length 13mm Top Head Diameter Green Nylon Interior Garnish Door Trim Panel Retainers Hyundai # 82315-2W000	25 Pcs.		

Retainers Moulding

15875PK	5/16" (8mm) Hole Size 12mm Stem Length 17mm Flange Diameter Gray Nylon Rocker Panel Moulding Retainers Hyundai # 85815-24100	25 Pcs.		
15874PK	23/64" (9mm) Hole Size 15mm Stem Length 13mm Top Head Diameter Gray Nylon Garnish & Interior Moulding Retainers Hyundai # 85849-3L000	50 Pcs.		

Kia Clips & Fasteners

Retainers Moulding

15873PK	5/16" (8mm) Hole Size 12mm Stem Length 13mm Top Head Diameter Gray Nylon Exterior & Interior Moulding Retainers Kia # 0K95-A-68401	50 Pcs.		
----------------	---	----------------	--	---

Disco Automotive Hardware

Ph: 580-622-3090

Fax: 580-622-3781

discosales@discoautomotive.com

CNP36

12/11/19

COOL NEW PRODUCTS

Ford Clips & Fasteners

Nuts Specialty

15839PK #12 (5.50mm) Screw Size
15mm Stem Length
16mm Head Diameter
10mm Hole Size
Natural Nylon Back Panel
Attachment Grommets
Ford # W700566-S300

25 Pcs.



Plugs Oil Drain

18257PK 13/16" Diameter
2 1/4" Overall Length
Tab for Removal
Yellow Plastic With Green "O" Ring
Oil Drain Plug
Ford KX6Z-6730-B

1 Pc.



Not Actual Size

Retainers Shield

9523PK 9/32" (7mm) Hole Size
1 3/32" Stem Length
1 1/32" Head Diameter
Black Nylon
Headliner Retainers
Ford # W710923-S300
G.M. # 10229437, 10242316

25 Pcs.



Retainers Push Type

15852PK 1/4" (6.40mm) Hole Size
17/32" Stem Length
5/8" Head Diameter
Black Nylon
Push Type Retainers
Ford # N805231S

50 Pcs.



15838PK 9/32" (7mm) Hole Size
10mm Stem Length
13mm Flange Diameter
Black Nylon Front Fender
Push Type Retainers
Ford # W707365-S300

10 Pcs.



Retainers Phillips Screw

9600PK 25/64" (10mm) Hole Size
11mm Stem Length
20 x 30mm Head Size
Nylon
Phillips Screw Retainers
Ford E7ZG-17A904-B
Mazda BF67-50-033

10 Pcs.



Disco Automotive Hardware

Ph: 580-622-3090

Fax: 580-622-3781

discosales@discoautomotive.com

CNP37

01/08/20

COOL NEW PRODUCTS

G.M. Clips & Fasteners

Nuts Specialty

15829PK #10 (4.8mm) Screw Size
8mm Stem Length
13mm Head Diameter
8mm Hole Size
White Nylon
License Plate Grommets
G.M. # 3783006

50 Pcs.



Bolts Body Metric

12057PK 8-1.25 x 35mm
13mm Indented Hex Head
24mm Outside Diameter Loose Washer
Black Finish
Metric Body Bolts
G.M. # 11503668

25 Pcs.



Chrysler Clips & Fasteners

Screws Hex Head Sems®

18097PK 4.8-1.61 x 32mm
8mm Indented Hex Head
19mm Outside Diameter Loose Washer
Black Phosphate
Sems® Screws
Chrysler # 6509539-AA

50 Pcs.



Audi Clips & Fasteners

Nuts Specialty

15862PK 5mm Stud Size
10mm Hex Size
18.50mm Flange Diameter
10.50mm Overall Height
Black Nylon
Moulding Flange Nuts
Audi # 171-201-969

25 Pcs.

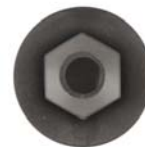

Honda Clips & Fasteners

Retainers Push Type

13236PK 9/32" (7mm) Hole Size
14mm Stem Length
16mm Head Diameter
Black Nylon Interior Trim
Push Type Retainers
Honda # 91550-S50-000ZL

15 Pcs.



Disco Automotive Hardware

Ph: 580-622-3090

Fax: 580-622-3781

discosales@discoautomotive.com

CNP38

01/08/20

COOL NEW PRODUCTS

Toyota Clips & Fasteners

Retainers Hood Seal

11978PK 13/64" (5mm) Hole Size
8mm Stem Length
5 x 13mm Head Size
Black Nylon
Hood Seal Retainers
Toyota # 65487-60010

25 Pcs.



Retainers Fender Seal

11979PK 5/16" (8mm) Hole Size
16mm Stem Length
16mm Head Diameter
Black Nylon
Fender Seal Retainers
Toyota # 90467-07208

25 Pcs.



Retainers Door Trim Panel

11976PK 23/64" (9mm) Hole Size
15mm Stem Length
10mm Top Head Size
Yellow Nylon With Sealer
Door Garnish Retainers
Toyota # 76817-68010

25 Pcs.



11977PK 23/64" (9mm) Hole Size
10mm Stem Length
13mm Top Head Diameter
Blue Nylon With Sealer
Door Trim Retainers
Toyota # 67771-26240

25 Pcs.



Retainers Moulding

11974PK 9/32" (7mm) Hole Size
11mm Stem Length
8mm Top Head Size
Yellow Nylon With Sealer
Rocker Moulding Retainers
Toyota # 62955-50010

25 Pcs.



11975PK 5/16" (8mm) Hole Size
10mm Stem Length
14.50 x 16mm Head Size
Black Nylon
Fender Liner Retainers
Toyota # 90467-06192

25 Pcs.



11973PK 9/16" (14mm) Hole Size
11mm Stem Length
25mm Head Diameter
Black Nylon
Rocker Moulding Retainers
Toyota # 76924-13020

25 Pcs.



Disco Automotive Hardware

Ph: 580-622-3090

Fax: 580-622-3781

discosales@discoautomotive.com

CNP39

01/22/20

COOL NEW PRODUCTS

Screws

Screws Phillips Flat Washer Head Teks

12647PK 8 x 1/2"
#2 Tek[®]
13/32" Outside Diameter Washer
Bright Zinc Finish
Phillips Flat Washer Head Screws



Screws Phillips Truss Head Trim

13362PK 4.2-1.41 x 16mm
Phillips Truss Head
9.50mm Head Diameter
Black Finish
Trim Screws



G.M. Clips & Fasteners

Screws Torx Truss Head

10123PK 5.50 x 20mm
Torx[®] Truss Head
15mm Outside Diameter Washer
Black Zinc Finish Screws
Use With # 15729
G.M. # 13144822



Ford Clips & Fasteners

Screws Phillips Oval Washer Head Tek[®]

12595PK 8 x 3/4"
Phillips Oval Washer Head
7/16" O.D. Washer
Bright Zinc Tek[®]
Door Scuff Plate
Ford # 382413-S9, 382413-S2



Retainers Shield

9510PK 1/4" (6.30mm) Hole Size
1 1/8" Stem Length
1" Head Diameter
Black Nylon Cowl Side Trim
Shield Retainers
Ford # E9SB-6302354-ACW



Chrysler Clips & Fasteners

Nuts Specialty

15868PK 8.50 x 11.00mm Hole Size
36mm Stem Length
18mm Head Diameter
Black Nylon Rocker Panel &
Splash Sheild Screw Grommet
With Specialty Screw
Chrysler # 6510123AA



Disco Automotive Hardware

Ph: 580-622-3090

Fax: 580-622-3781

discosales@discoautomotive.com

CNP40

01/22/20

COOL NEW PRODUCTS

Service Equipment

Cabinet Large 4 Drawer

80371

23 1/2" Width 22" Depth 15" Height
Gray Finish
Large 4 Drawer Cabinet
Does Not Include, Trays or Dividers

1 Pc.



Not Actual Size

Service Equipment

Drawer Dividers, Gray Finish

80370

Cabinet Drawer Dividers
5 1/8" Width x 2 7/8" Height
Gray Plastic
Use With # 80369

1 Pc.



Not Actual Size

Jumbo Tray Gray Plastic

80369

20 5/8" x 21 1/4" x 3"
Adjustable
Gray Plastic Jumbo Tray
Used With Cabinets # 80360 & 80371

1 Pc.



Not Actual Size

Disco Automotive Hardware

Ph: 580-622-3090

Fax: 580-622-3781

discosales@discoautomotive.com

CNP41

05/20/20

COOL NEW PRODUCTS

Base Gray Finish

80361 23 1/2" Width 22" Depth 6" Height
Gray Finish
Large Cabinet Base
Use With # 80360 & # 80371

1 Pc.



Not Actual Size

G.M. Clips & Fasteners

Nuts Specialty

15691PK 4.2-1.41 #8 Screw Size
Zinc Organic
Center Console Door,
Front Lights, Grille,
Lift Gate Nuts With Silicone Pad
G.M. # 11610157

10 Pcs.

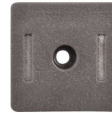

Nuts Well Black Rubber

15953PK 10-24 Screw Size
3/8" Hole Size 37/64" Length
.030-.227" Grip Range
Black Rubber
Well Nuts
G.M. # 3876130

25 Pcs.



Retainers Moulding

14995PK 10mm Stem Length
17 x 24mm Top Head Size
Blue Nylon With Sealer
Interior Trim & Windshield Pillar
Moulding Retainers
G.M. # 11611367

10 Pcs.



Ford Clips & Fasteners

Nuts Specialty

15983PK #8 (4.80mm) Screw Size
7mm Stem Length
14mm x 23mm Head Size
Zinc Organic
Front & Rear Bumper
Specialty Nuts With Pastisol Pad
Ford # W715197-S439

10 Pcs.



Disco Automotive Hardware

Ph: 580-622-3090

Fax: 580-622-3781

discosales@discoautomotive.com

CNP42

05/20/20

COOL NEW PRODUCTS

BMW Clips & Fasteners

Nuts Specialty

11954PK #8 (4.20mm) Screw Size
3mm-4mm Panel Range
7mm Center of Hole to Edge
Zinc Finish
Speed Type "U" Nuts
BMW # 0712-9-925-708
Mercedes # 000-994-25-45

50 Pcs.



Honda Clips & Fasteners

Retainers Push Type

13221PK 25/64" (10mm) Hole Size
12mm Stem Length
30mm Head Diameter
Black Nylon
Engine Cover Push Retainers
Honda # 91505-TY2-003

15 Pcs.

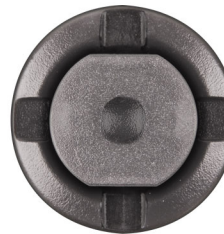

Mazda Clips & Fasteners

Retainers Push Type

15853PK 15/64" (6mm) Hole Size
16mm Stem Length
14mm Head Diameter
Black Nylon
Interior Trim
Push Type Retainers
Mazda # B101-68-252-00

25 Pcs.



Toyota Clips & Fasteners

Nuts Specialty

15812PK #12 (5.50mm) Screw Size
17mm Stem Length
20mm Head Diameter
9mm Square Hole Size
Black Nylon
Screw Grommets
Toyota # 90189-A0002

25 Pcs.

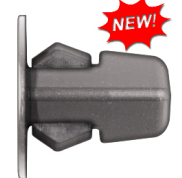
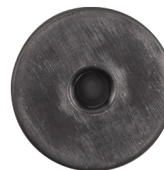

Retainers Cowl Panel

15947PK 9/32" (7mm) Hole Size
14mm Stem Length
8mm x 17mm Head Size
Black Nylon
Cowl Panel Retainers
Toyota # 90467-10146

25 Pcs.



Disco Automotive Hardware

Ph: 580-622-3090

Fax: 580-622-3781

discosales@discoautomotive.com

CNP43

05/20/20

COOL NEW PRODUCTS

Rivets



Rivets Self Piercing (SPR)

18133PK	5.30 x 10.00mm Silver Steel H4 ALMAC Self Piercing Rivets (SPR) Check OEM or OE Vendor Specs. Before Using This Part	100 Pcs.		 NEW!
----------------	--	-----------------	---	---



18134PK	5.30 x 12.00mm Silver Steel H4 ALMAC Self Piercing Rivets (SPR) Check OEM or OE Vendor Specs. Before Using This Part	100 Pcs.		 NEW!
----------------	--	-----------------	---	---

G.M. Clips & Fasteners

Retainers Fascia



9311PK	1/4" (6.30mm) Hole Size 1 1/16" Stem Length 1/2" Head Diameter Black Nylon Rear Bumper Fascia Retainers G.M. # 22536642	50 Pcs.		 NEW!
---------------	--	----------------	--	---

Retainers Moulding

15870PK	23/64" (9mm) Hole Size 16mm Stem Length 12 x 20mm Top Head Size Blue Nylon With Sealer Rocker Moulding Retainers G.M. # 11547211	10 Pcs.		 NEW!
----------------	---	----------------	---	--

Kia Clips & Fasteners

Retainers Moulding

15978PK	7/16" (11mm) Hole Size 12mm Stem Length 10 x 12mm Top Head Size Gray Nylon With Sealer Liftgate Moulding Clips Kia # 87382-2W000	25 Pcs.		 NEW!
----------------	---	----------------	--	---

Disco Automotive Hardware

Ph: 580-622-3090

Fax: 580-622-3781

discosales@discoautomotive.com

CNP44

06/24/20

COOL NEW PRODUCTS

Standard Fasteners

Screws Grade 8 Hex Head Yellow Zinc

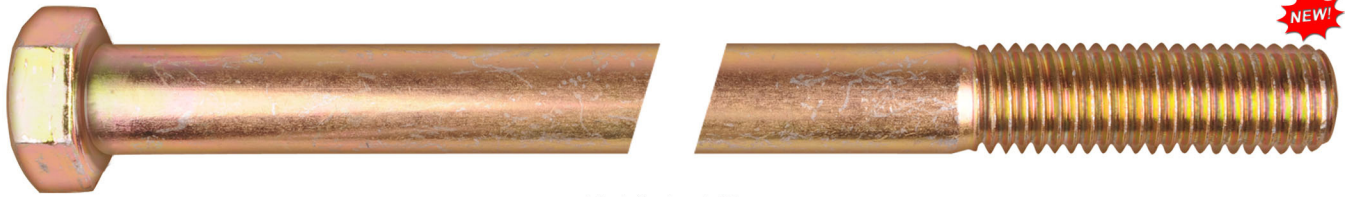

Not Actual Size

Part #	Size	Hex Head	Qty.
11569PK	5/8-11 x 7" USS	15/16"	1Pc.
11591PK	3/4-10 x 7" USS	1 1/8"	1 Pc.
11594PK	3/4-10 x 8 1/2" USS	1 1/8"	1 Pc.
11624PK	1-8 x 8 1/2" USS	1 1/2"	1 Pc.

Shield Retainers

Retainers Shield

15980PK 13/64" (5.20mm) Hole Size
11/16" Stem Length
3/4" Head Diameter
.065-.515" Panel Range
Black Nylon
Shield Retainers

50 Pcs.



Chrysler Clips & Fasteners

Retainers Grille

15688PK 19/64" (7.50mm) Hole Size
14mm Stem Length
10 x 42mm Head Size
Black Nylon Front Bumper
Fascia To Grille Retainers
Chrysler # 4857699-AA

25 Pcs.



Subaru Clips & Fasteners

Retainers Push Type

15321PK 9/32" (7mm) Hole Size
10mm Stem Length
15mm Head Diameter
Black Nylon
Cowl & Bumper
Push Type Retainers
Subaru # 90914-0062

15 Pcs.



Disco Automotive Hardware

Ph: 580-622-3090

Fax: 580-622-3781

discosales@discoautomotive.com

CNP45

06/24/20

COOL NEW PRODUCTS

Ford Clips & Fasteners

Nuts Specialty

11909PK 10-1.50mm Screw Size
15mm Hex Size
24mm O.D. Loose Washer
Black Finish
Metric Hex Nuts
Chrysler # 6100053
Ford # N621942-S301, N621942-S441,
N621942-S2

25 Pcs.



Mazda Clips & Fasteners

Retainers Push Type

15951PK 9/32" (7mm) Hole Size
11mm Stem Length
11mm Head Diameter
Black Nylon
Push Type Retainers
Mazda # S51S-51-833

15 Pcs.



Assortments

Assortments Windshield Pillar Moulding

# 8102 Windshield Pillar Moulding Clip Assortment					
# 18095PK 11mm Stem Length 17 x 20mm Top Hd. Size Blue Nylon W/Metal Reinforced Windshield Pillar, Interior & Trunk Trim Moulding Retainers	# 13519PK 10mm Stem Length 17 x 24mm Top Head Red Nylon Metal Reinforced Door Sill Plate Retainers	# 13104PK 10mm Stem Length 17 x 24mm Top Hd. Size Blue Nylon W/Metal Reinforced Interior Trim & Windshield Pillar Moulding Retainers	# 17588PK 10mm Stem Length 17 x 24mm Top Hd. Size Red Nylon W/Metal Reinforced Case Fuses Interior Trim & Windshield Garnish Moulding Retainers	# 18165PK 12mm Stem Length 17mm x 20mm Top Hd. Sz. Black Nylon W/Metal Reinforced Windshield Pillar & Interior Moulding Retainers	# 14995PK 10mm Stem Length 17 x 24mm Top Head Size Blue Nylon W/ Sealer W/Metal Reinforced Interior Trim & Windshield Pillar Moulding Retainers



8102 Contains 6 Different Sizes
90 Total Pieces
Interior & Trunk Trim
Windshield Pillar
Moulding Clip Assortment

Sold Each

Disco Automotive Hardware

Ph: 580-622-3090

Fax: 580-622-3781

discosales@discoautomotive.com























CNP46

08/19/20

COOL NEW PRODUCTS

Assortments

Assortment Multi Grip Rivet

# 8218 Multi Grip Rivet Assortment					
# 17051PK  1/8" Diameter 5/32" - 5/16" Grip Range 1/4" Flange Size Aluminum Steel Multi Grip Pop Rivets 	# 17052PK  1/8" Diameter 5/32" - 5/16" Grip Range 3/8" Flange Size Aluminum Steel Multi Grip Pop Rivets 	# 17053PK  1/8" Diameter 1/4" - 7/16" Grip Range 1/4" Flange Size Aluminum Steel Multi Grip Pop Rivets 	# 17054PK  5/32" Diameter 3/64" - 1/4" Grip Range 13/32" Flange Size Aluminum Steel Multi Grip Pop Rivets 	# 17057PK  3/16" Diameter 1/16" - 1/4" Grip Range 3/8" Flange Size Aluminum Steel Multi Grip Pop Rivets 	# 17058PK  3/16" Diameter 1/16" - 1/4" Grip Range 5/8" Flange Size Aluminum Steel Multi Grip Pop Rivets 
# 17059PK  3/16" Diameter 3/16" - 3/8" Grip Range 3/8" Flange Size Aluminum Steel Multi Grip Pop Rivets 	# 17060PK  3/16" Diameter 1/4" - 1/2" Grip Range 3/8" Flange Size Aluminum Steel Multi Grip Pop Rivets 	# 17061PK  3/16" Diameter 1/4" - 1/2" Grip Range 5/8" Flange Size Aluminum Steel Multi Grip Pop Rivets 	# 17062PK  3/16" Diameter 7/16" - 3/4" Grip Range 3/8" Flange Size Aluminum Steel Multi Grip Pop Rivets 	# 17063PK  1/4" Diameter 5/64" - 1/32" Grip Range 1/2" Flange Size Aluminum Steel Multi Grip Pop Rivets 	



8218 Contains 11 Different Sizes
 150 Total Pieces
 1/8 to 1/4" Hole Size
 Aluminum Rivet Steel Mandrel
 Pop Multi Grip Rivets

1 Pc.

Standard Fasteners

Nuts Serrated Flange Zinc



Part #	Screw Size	Hex Size	Flange	Type	Finish	Qty.
15784PK	1/4"-20	7/16"	19/32"	USS	Zinc	100 Pcs.
15785PK	5/16"-18	1/2"	11/16"	USS	Zinc	100 Pcs. NEW
256PK	3/8"-16	9/16"	3/4"	USS	Zinc	100 Pcs.
9078PK	7/16"-14	11/16"	15/16"	USS	Zinc	50 Pcs.

Electrical Products

Bulb Miniature Light

75202 Clear 12 Volt 24 Watt
 Bulb Shape G-6
 Bass Type PG20-3
 Usage: Fog Lights
 Miniature Light Bulbs
 Industrial # 5202

1 Pc.



Disco Automotive Hardware

Ph: 580-622-3090

Fax: 580-622-3781

discosales@discoautomotive.com

CNP47

09/02/20

COOL NEW PRODUCTS

Standard Fasteners

Nuts Hex Grade 8 Nylon Insert Lock Bright Yellow Zinc Finish

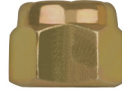

Part #	Size	Hex Size	Type	Finish	Qty.	
12378PK	1/4"-20	7/16"	USS	Yellow Zinc	100 Pcs.	NEW
12379PK	5/16"-18	1/2"	USS	Yellow Zinc	100 Pcs.	NEW
12380PK	3/8"-16	9/16"	USS	Yellow Zinc	100 Pcs.	
12381PK	7/16"-14	11/16"	USS	Yellow Zinc	50 Pcs.	NEW
12382PK	1/2"-13	3/4"	USS	Yellow Zinc	50 Pcs.	
12383PK	9/16"-12	7/8"	USS	Yellow Zinc	25 Pcs.	
12384PK	5/8"-11	15/16"	USS	Yellow Zinc	25 Pcs.	
12385PK	3/4"-10	1 1/8"	USS	Yellow Zinc	25 Pcs.	
12386PK	7/8"-9	1 5/16"	USS	Yellow Zinc	10 Pcs.	
12387PK	1"-8	1 1/2"	USS	Yellow Zinc	10 Pcs.	NEW

Honda Clips & Fasteners

Retainers Moulding

15976PK

16.50mm Overall Height
9mm Width
White Nylon
Grille Moulding Clips
Honda # 90666-SDA-A01

25 Pcs.



Toyota Clips & Fasteners

Retainers Push Type

15952PK

9/32" (7mm) Hole Size
10mm Stem Length
20mm Head Diameter
Black Nylon Fender Liner
Push Type Retainers
Toyota # 90467-07215

25 Pcs.



15954PK

42mm Width
29.50mm Length
Black Nylon
Fender Liner Retainers
Use With # 11950
Toyota # 53879-30050

15 Pcs.



Disco Automotive Hardware

Ph: 580-622-3090

Fax: 580-622-3781

discosales@discoautomotive.com

CNP48

10/24/20

COOL NEW PRODUCTS

BMW Clips & Fasteners

Retainers Torx Screw

15979PK

11/16" (7mm) Hole Size
T10 Torx® Drive
7mm Stem Length
20mm Head Diameter
Black Nylon
Rocker Trim Wheelhouse Retainers
Use With # 13372 & 13377
BMW # 07-14-7-122-913

15 Pcs.



Retainers Door Trim Panel

13377PK

1/2" (12.70mm) Hole Size
27mm Stem Length
30mm Head Diameter
Black Nylon Rocker Moulding &
Door Sill Trim Retainers
Use With # 15979
BMW # 51717066226

15 Pcs.



13372PK

1/2" (12.70mm) Hole Size
32mm Stem Length
30mm Head Diameter
Black Nylon
Rocker Panel & Wheelhouse
Trim Retainers
Use With # 15979
BMW # 07147122912

15 Pcs.



Retainers Moulding

15977PK

5/16" (8mm) Hole Size
11mm Stem Length
11 x 19mm Top Head Size
Gray Nylon
Moulding Retainers
BMW # 07-13-2-757-821, 003-80-14348

15 Pcs.



Honda Clips & Fasteners

Retainers Push Type

15981PK

5/16" (8mm) Hole Size
21mm Stem Length
16mm Head Diameter
Black Nylon Rear Panel
Push Type Retainers
Honda # 91561-S84-A00-M1,
91561-S84-A21ZB

10 Pcs.



Disco Automotive Hardware

Ph: 580-622-3090

Fax: 580-622-3781

discosales@discoautomotive.com

CNP49

12/23/20

COOL NEW PRODUCTS

Service Equipment

Storage Bins, 72 Hole



80375

This Cabinet will not fit
Old discontinued numbers below:
Gray Base 80356
Gray Stand 80353
Gray Storage Bin 80341

Part #	Width	Depth	Height	Finish	Use With	Qty.	
80375	33 3/4"	12"	42"	Gray	# 80372 & 80378	1 Pc.	NEW

Storage Bins, 40 Hole

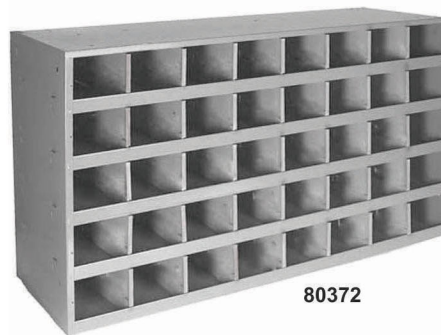

80372

These Cabinets will not fit
Old discontinued numbers below:
Gray Base 80356
Gray Stand 80353
Gray Storage Bin 80364

Part #	Width	Depth	Height	Finish	Use With	Qty.	
80372	33 3/4"	12"	23 7/8"	Gray	# 80375 & 80378	1 Pc.	NEW

Storage Bins, Stand



80378

These Stands will not fit
Old discontinued numbers below:
Gray Storage Bin 80364
Gray Storage Bin 80341

Part #	Width	Depth	Height	Finish	Use With	Qty.	
80378	33 3/4"	12 1/4"	5 3/4"	Gray	# 80372 & 80375	1 Pc.	NEW

Disco Automotive Hardware

Ph: 580-622-3090

Fax: 580-622-3781

discosales@discoautomotive.com

CNP50

12/23/20

COOL NEW PRODUCTS

Service Equipment

Trays Large Metal Gray Finish

80382

18" Width x 12" Depth x 3" Height
24 Hole with Catch
Large Gray Metal Tray

1 Pc.



Not Actual Size

Racks 4 Rods Wire Spool Gray Finish

80381

26 1/8" Width x 5 7/8" Depth 36 1/2" Height
Gray Finish
Wire Spool Rack

1 Pc.



Not Actual Size

Disco Automotive Hardware

Ph: 580-622-3090

Fax: 580-622-3781

discosales@discoautomotive.com

CNP51

12/23/20

COOL NEW PRODUCTS

Service Equipment

Stands Large 4 Drawer Cabinet Gray Finish



NEW!

This stand made to fit slider #80328 only.

80329 20 3/4" Width 14 1/4" Depth 15" Height
Gray Finish
Metal Slider Stand
Use With # 80328

1 Pc.

Cabinets With Ball Bearing Sliders Gray Finish

High Quality Ball Bearing Sliders



NEW!

This slider made to fit stand #80329 only.

80328 20 1/2" Width 14" Depth 15" Height
Gray Finish Holds 4 Trays
With Ball Bearings
Large Metal Slider
Use With # 80329

1 Pc.

Disco Automotive Hardware

Ph: 580-622-3090

Fax: 580-622-3781

discosales@discoautomotive.com

CNP52

01/13/21

COOL NEW PRODUCTS

G.M. Clips & Fasteners

Nuts Specialty

18261PK

4.80mm Stud Size
17mm Head Diameter
9.80mm Hole Size
Black Rubber
Tail Lamp Grommet
G.M. # 11571225

10 Pcs.



Retainers Headliner

16062PK

9mm Stem Length
12 x 22mm Top Head Size
Black Nylon
Headliner Retainers
G.M. # 11547523, 11601777

15 Pcs.



Retainers Door Trim Panel

15985PK

15/64" (6mm) Hole Size
9mm Stem Length
10mm Top Head Diameter
White Nylon
Door Panel Retainers
G.M. # 11602522, 11603260

25 Pcs.



Ford Clips & Fasteners

Retainers Door Trim Panel

16061PK

6mm (15/64") Hole Size
9mm Stem Length
12.50mm Head Diameter
Black Nylon Bumper &
Mud Guard Retainers
Ford # W718046-S300

25 Pcs.

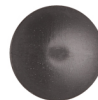

16060PK

8mm (5/16") Hole Size
17mm Stem Length
20mm Head Diameter
Black Nylon Fender, Bumper &
Interior Trim Retainers
Ford # W715926-S300

25 Pcs.



Disco Automotive Hardware

Ph: 580-622-3090

Fax: 580-622-3781

discosales@discoautomotive.com

CNP53

01/13/20

COOL NEW PRODUCTS

Metric Fasteners

Screws Metric Class 10.9 Hex Head Cap Yellow Zinc Finish



DIN # 933
Full Threaded



DIN # 931
Partially Threaded

Part #	Size	Hex Size	Din	Qty.
14424PK	6-1.00 x 10mm	10mm	933	50 Pcs.
14425PK	6-1.00 x 12mm	10mm	933	50 Pcs. NEW
14426PK	6-1.00 x 16mm	10mm	933	25 Pcs. NEW
14427PK	6-1.00 x 20mm	10mm	933	25 Pcs.
14428PK	6-1.00 x 25mm	10mm	933	25 Pcs.
14429PK	6-1.00 x 30mm	10mm	933	25 Pcs.
14431PK	6-1.00 x 40mm	10mm	933	25 Pcs.
14433PK	6-1.00 x 50mm	10mm	931	25 Pcs.
14435PK	6-1.00 x 60mm	10mm	931	25 Pcs.
14437PK	6-1.00 x 70mm	10mm	931	25 Pcs.
14439PK	6-1.00 x 80mm	10mm	931	25 Pcs.

Shield Retainers

Weatherstrip Retainers

12066PK 13/64" (5mm) Hole Size 50 Pcs.
10mm Stem Length
5 x 15mm Head Diameter
White Nylon
Weatherstrip Retainers



Tools & Supplies

Bits Carbide Spot Weld Drill

16066PK 8mm Drill Size 1 Pc.
For 5/16" Spot Welds
3-Edged High Speed
Drills Through Boron Steel
Black Finish
Carbide Spot Weld Drill Bits



Nissan Clips & Fasteners

Retainers Door Trim Panel

15896PK 8mm Hole Size 25 Pcs.
14mm Stem Length
13mm Top Head Diameter
White Nylon
Quarter Panel Trim Retainers
Nissan # 01553-0162U



Disco Automotive Hardware

COOL NEW PRODUCTS

8814



Self Piercing & Blind Rivets Assortment

BACK OF TRAY					
# 8814 Self Piercing & Blind Rivets Assortment					
18121PK 3.35 x 3.5mm Silver Steel H4 ALMAC Self Piercing Rivets (SPR) Check OEM or OE Vendor Specs. Before Using This Part 1	18122PK 3.35 x 4.0mm Silver Steel H4 ALMAC Self Piercing Rivets (SPR) Check OEM or OE Vendor Specs. Before Using This Part 2	18123PK 3.35 x 5.0mm Silver Steel H4 ALMAC Self Piercing Rivets (SPR) Check OEM or OE Vendor Specs. Before Using This Part 3	18124PK 3.35 x 6.0mm Silver Steel H4 ALMAC Self Piercing Rivets (SPR) Check OEM or OE Vendor Specs. Before Using This Part 4	18125PK 5.3 x 4.0mm Silver Steel H4 ALMAC Self Piercing Rivets (SPR) Check OEM or OE Vendor Specs. Before Using This Part 5	9054PK 17/64" (6.80mm) Diameter 1/2" Flange Size 3/32" - 3/16" Grip Range Black Nylon Blind Rivets 6
18126PK 5.3 x 5.0mm Silver Steel H4 ALMAC Self Piercing Rivets (SPR) Check OEM or OE Vendor Specs. Before Using This Part 7	18127PK 5.3 x 6.0mm Silver Steel H4 ALMAC Self Piercing Rivets (SPR) Check OEM or OE Vendor Specs. Before Using This Part 8	18128PK 5.3 x 6.5mm Silver Steel H4 ALMAC Self Piercing Rivets (SPR) Check OEM or OE Vendor Specs. Before Using This Part 9	18129PK 5.3 x 7.0mm Silver Steel H4 ALMAC Self Piercing Rivets (SPR) Check OEM or OE Vendor Specs. Before Using This Part 10	18130PK 5.3 x 7.5mm Silver Steel H4 ALMAC Self Piercing Rivets (SPR) Check OEM or OE Vendor Specs. Before Using This Part 11	1390PK 1/4" (6.40mm) Diameter 1/2" Flange Size 5/32" - 13/32" Grip Range Black Nylon Blind Rivets 12
18131PK 5.3 x 8.0mm Silver Steel H4 ALMAC Self Piercing Rivets (SPR) Check OEM or OE Vendor Specs. Before Using This Part 13	18132PK 5.3 x 9.0mm Silver Steel H4 ALMAC Self Piercing Rivets (SPR) Check OEM or OE Vendor Specs. Before Using This Part 14	18133PK 5.3 x 10.0mm Silver Steel H4 ALMAC Self Piercing Rivets (SPR) Check OEM or OE Vendor Specs. Before Using This Part 15	18134PK 5.3 x 12.00mm Silver Steel H4 ALMAC Self Piercing Rivets (SPR) Check OEM or OE Vendor Specs. Before Using This Part 16	1195PK 13/64" (5.20mm) Diameter 15/32" Flange Size 15/64" - 25/64" Grip Range Black Nylon Blind Rivets 17	5770PK 1/4" (6.40mm) Diameter 21/32" Flange Size 5/32" - 13/32" Grip Range Black Nylon Blind Rivets 18
13328PK 1/4" (6.30mm) Diameter 1/2" Flange Size .060" - .138" Grip Range F-150 Trucks With Alum. Body All Steel Pop Rivets 19	12623PK 1/4" (6.30mm) Diameter 1/2" Flange Size .110" - .189" Grip Range F-150 Trucks With Alum. Body All Steel Pop Rivets 20	12625PK 1/4" (6.30mm) Diameter 1/2" Flange Size .189" - .238" Grip Range F-150 Trucks With Alum. Body All Steel Pop Rivets 21	13329PK 1/4" (6.30mm) Diameter 1/2" Flange Size .268 - .346" Grip Range F-150 Trucks With Alum. Body All Steel Pop Rivets 22	5769PK 13/64" (5.20mm) Diameter 15/32" Flange Size 1/8" - 15/64" Grip Range Black Nylon Blind Rivets 23	5775PK 17/64" (6.80mm) Diameter 23/32" Flange Size 3/32" - 3/16" Grip Range Black Nylon Blind Rivets 24
FRONT OF TRAY					

Contains 24 Different Sizes
1,055 Total Pieces
3.5 - 6.80mm Hole Size
Self Piercing, Nylon &
Pop Rivet Assortment



Part #	Tray Type	Material	Tray #	Tray Color	Lid Color	Label Type	Clear Pocket	Qty.	
8814	24 Hole	Plastic	80123	Gray	Gray	Adhesive	No	1 Pc.	NEW
8814BCP	24 Hole	Plastic	80155BC	Dark Blue	Clear	Paper	Yes	1 Pc.	NEW
8814GCP	24 Hole	Plastic	80123GC	Gray	Clear	Paper	Yes	1 Pc.	NEW
8814RCP	24 Hole	Plastic	80152RC	Red	Clear	Paper	Yes	1 Pc.	NEW
8814YCP	24 Hole	Plastic	80123YC	Yellow	Clear	Paper	Yes	1 Pc.	NEW

Disco Automotive Hardware

Ph: 580-622-3090

Fax: 580-622-3781

discosales@discoautomotive.com

CNP55

02/10/21

COOL NEW PRODUCTS

8815



Hex Washer Head Tek® Screw Assortment

BACK OF TRAY					
# 8815 Hex Washer Head Tek® Screw Assortment					
12215PK 8 x 1/2" 1/4" Indented Hex Head #2 Tek Point Black Finish Tek® Screws	12216PK 8 x 3/4" 1/4" Indented Hex Head #2 Tek Point Black Finish Tek® Screws	12217PK 8 x 1" 1/4" Indented Hex Head #2 Tek Point Black Finish Tek® Screws	12222PK 10 x 1/2" 5/16" Indented Hex Head #2 Tek Point Black Finish Tek® Screws	12223PK 10 x 3/4" 5/16" Indented Hex Head #3 Tek Point Black Finish Tek® Screws	1970PK 14 x 3/4" 3/8" Indented Hex Head #3 Tek Point Bright Zinc Finish Tek® Screws
12224PK 10 x 1" 5/16" Indented Hex Head #3 Tek Point Black Finish Tek® Screws	1077PK 8 x 1/2" 1/4" Indented Hex Head #2 Tek Point Bright Zinc Finish Tek® Screws	1078PK 8 x 3/4" 1/4" Indented Hex Head #2 Tek Point Bright Zinc Finish Tek® Screws	9791PK 8 x 1" 1/4" Indented Hex Head #2 Tek Point Bright Zinc Finish Tek® Screws	9792PK 8 x 1 1/4" 1/4" Indented Hex Head #2 Tek Point Bright Zinc Finish Tek® Screws	1971PK 14 x 1" 1/2" Flange Size #3 Tek Point Bright Zinc Finish Tek® Screws
9353PK 8 x 1 1/2" 1/4" Indented Hex Head #3 Tek Point Bright Zinc Finish Tek® Screws	9841PK 10 x 1/2" 5/16" Indented Hex Head #2 Tek Point Bright Zinc Finish Tek® Screws	1079PK 10 x 5/8" 5/16" Indented Hex Head #3 Tek Point Bright Zinc Finish Tek® Screws	9346PK 10 x 3/4" 5/16" Indented Hex Head #3 Tek Point Bright Zinc Finish Tek® Screws	1080PK 10 x 1" 5/16" Indented Hex Head #3 Tek Point Bright Zinc Finish Tek® Screws	9797PK 14 x 1 1/4" 3/8" Indented Hex Head #3 Tek Point Bright Zinc Finish Tek® Screws
9793PK 10 x 1 1/4" 5/16" Indented Hex Head #3 Tek Point Bright Zinc Finish Tek® Screws	9794PK 10 x 1 1/2" 5/16" Indented Hex Head #3 Tek Point Bright Zinc Finish Tek® Screws	9843PK 12 x 3/4" 5/16" Indented Hex Head #3 Tek Point Bright Zinc Finish Tek® Screws	9795PK 12 x 1" 5/16" Indented Hex Head #3 Tek Point Bright Zinc Finish Tek® Screws	9796PK 12 x 1 1/4" 5/16" Indented Hex Head #3 Tek Point Bright Zinc Finish Tek® Screws	9842PK 14 x 1 1/2" 3/8" Indented Hex Head #3 Tek Point Bright Zinc Finish Tek® Screws
FRONT OF TRAY					

Contains 24 Different Sizes
835 Total Pieces
Black & Bright Zinc Finish
Hex Washer Head
Tek® Screws Assortment

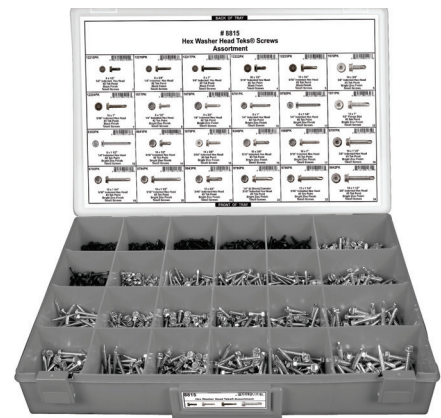

Part #	Tray Type	Material	Tray #	Tray Color	Lid Color	Label Type	Clear Pocket	Qty.	
8815	24 Hole	Plastic	80123	Gray	Gray	Adhesive	No	1 Pc.	NEW
8815BCP	24 Hole	Plastic	80155BC	Dark Blue	Clear	Paper	Yes	1 Pc.	NEW
8815GCP	24 Hole	Plastic	80123GC	Gray	Clear	Paper	Yes	1 Pc.	NEW
8815RCP	24 Hole	Plastic	80152RC	Red	Clear	Paper	Yes	1 Pc.	NEW
8815YCP	24 Hole	Plastic	80123YC	Yellow	Clear	Paper	Yes	1 Pc.	NEW

Disco Automotive Hardware

Ph: 580-622-3090

Fax: 580-622-3781

discosales@discoautomotive.com

CNP56

02/10/21

COOL NEW PRODUCTS

Assortments

Kits Disco Starter

Disco Starter Kit # 8056



NEW!

This Setup Covers
All The Items On
The Disco
1EP Wall Poster



*Shelves Not Included



Contains:

- 5 Bags of the top 50 most popular
- 4 Bags of the next 50 most popular
- 2 Bags of the last 112 items
- 212 of the 4" Storage Boxes
- 5 Catalogs & 10 of the 1EP Wall Posters

- No guessing on what to order & how to stock
- Great system for PBE or Warehouse Suppliers
- Top 212 most popular body shop items
- Ready to sell in 674 packaged bags with photo & description.
- Supplied with bin boxes, labels with photos, quantity & description.
- Includes: Wall Charts, Catalogs & Planographs on how to set up & lots more
- The #8056 Disco Starter System comes with everything you need to get you selling A.S.A.P.

8056

Top Selling 212 Items
674 Total Bags
Includes: Catalogs, Posters,
Labels & Storage Bin Boxes

1 Pc.

Disco Automotive Hardware

Ph: 580-622-3090

Fax: 580-622-3781

discosales@discoautomotive.com

CNP57

04/28/21

COOL NEW PRODUCTS

Tools & Supplies

Wheels Rubber Eraser

16057

Smooth Style
3 1/2" Outside Diameter
15mm Width
5/16 - 24 Spindle/ Adapter
Rubber Eraser Wheel
4000 Max RPM
For the removal vinyl decals, pinstripping,
adhesive tapes from metal, glass,
fiberglass and wood without damaging
sub-surface.

1 Pc.



Not Actual Size

16058

Sun Flower Style
3 1/2" Outside Diameter
20mm Width
5/16 - 24 Spindle/ Adapter
Rubber Eraser Wheel
4000 Max RPM
For the removal vinyl decals, pinstripping,
adhesive tapes from metal, glass,
fiberglass and wood without damaging
sub-surface.

1 Pc.

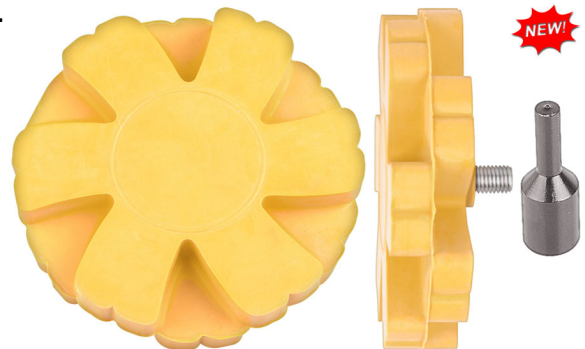

Not Actual Size

16059

Tractor Tire Style
4" Outside Diameter
26mm Width
5/16 - 24 Spindle/ Adapter
Rubber Eraser Wheel
4000 Max RPM
For the removal vinyl decals, pinstripping,
adhesive tapes from metal, glass,
fiberglass and wood without damaging
sub-surface.

1 Pc.

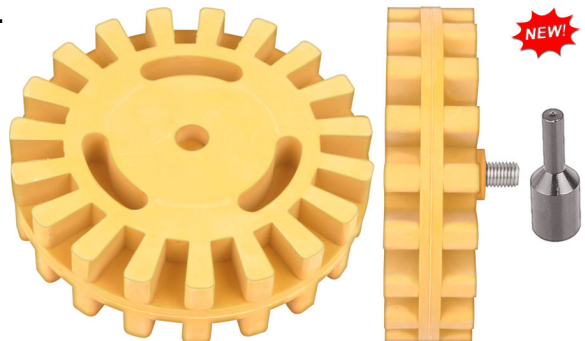

Not Actual Size

Disco Automotive Hardware

Ph: 580-622-3090

Fax: 580-622-3781

discosales@discoautomotive.com







CNP58

04/28/21

COOL NEW PRODUCTS

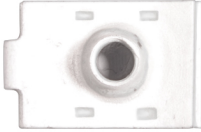
G.M. Clips & Fasteners

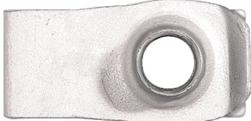

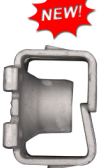

Nuts Extruded "U"

16078PK	4.2-1.41 Screw Size 2 - 3mm Panel Range 9.50mm Center of Hole to Edge Zinc Organic Extruded "U" Nuts G.M. # 11548579	25 Pcs.		
16081PK	6-1.00 Screw Size .70 - 2mm Panel Range 14mm Center of Hole to Edge Zinc Organic Extruded "U" Nuts G.M. # 11611321	10 Pcs.		
16080PK	8-1.25 Screw Size .80 - 4mm Panel Range 21mm Center of Hole to Edge Zinc Finish Extruded "U" Nuts Ford # W520813-S439 G.M. # 11516150	15 Pcs.		



Nuts Specialty

15902PK	6-1.00mm Screw Size 12mm Overall Height Organic Zinc Finish Front Fender Panel Nuts G.M. # 11610544	10 Pcs.		
----------------	---	----------------	--	--

Rivets Automotive

15170PK	5/32" (4mm) Rivet Diameter 7/16" Flange Diameter 3/64" - 3/8" Grip Range Alum Rivet S/Steel Mandrel Front & Rear Bumper Rivets G.M. # 9132667	25 Pcs.		
10962PK	3/16" (4.70mm) Rivet Diameter 5/8" Flange Diameter 1/4" - 3/8" Grip Range Black Finish All Steel Fascia To Bumper Rivets G.M. # 9439719	50 Pcs.		

Retainers Door Trim Panel

16091PK	23/64" (9mm) Hole Size 17mm Stem Length 15mm Top Head Diameter Natural Nylon With Sealer Door Trim Panel Retainers G.M. # 11549307	15 Pcs.		
----------------	---	----------------	--	---

Disco Automotive Hardware

Ph: 580-622-3090

Fax: 580-622-3781

discosales@discoautomotive.com

CNP59

06/09/21

COOL NEW PRODUCTS

G.M. Clips & Fasteners

Retainers Moulding

18263PK

23/64" (9mm) Hole Size
11mm Stem Length
12.50 x 23mm Top Head
White Nylon
Tailgate Cover Retainers
G.M. # 11611626

25 Pcs.

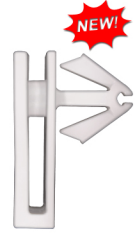

16087PK

25/64" (10mm) Hole Size
17mm Stem Length
22 x 46mm Head Size
Green Nylon
Rocker Moulding Retainers
G.M. # 25744385

15 Pcs.



Ford Clips & Fasteners

Nuts Specialty

12053PK

5 - .80mm Thread Size
8mm Hex Size
10mm O.D. Loose Washer
Yellow Zinc Finish
Metric Hex Nuts
Ford # N802775-S36

50 Pcs.



Retainers Hood Insulation

16082PK

17mm Overall Height
15mm Stem Length
25 x 30mm Head Size
Black Nylon
Hood Insulation Retainers
Ford # W716783-S300

25 Pcs.



Retainers Trim Panel

16083PK

9/32" (7mm) Hole Size
45mm Stem Length
18mm Head Diameter
Black Nylon
Trim Panel Retainers
Ford # W719084-S300

25 Pcs.

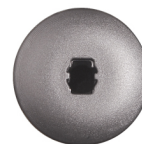

Retainers Moulding

15943PK

3/8" (9.50mm) Hole Size
14mm Stem Length
13mm Top Head Diameter
Black Nylon With Sealer
Rear Bumper Retainers
Ford # W718033-S300

10 Pcs.



Disco Automotive Hardware

Ph: 580-622-3090

Fax: 580-622-3781

discosales@discoautomotive.com

CNP60

06/09/21

COOL NEW PRODUCTS

Electrical Products

Cable Ties



12019PK 6" Length .140" Width **100 Pcs.**
1.42" Max Bundle Diameter
40 lbs. Tensile Strength
Black Nylon
Cable Ties

Cable Ties Mounts

16053PK Use with # 6 Flat Head Screw **100 Pcs.**
Accepts 18 lb To 50 lb Ties
4 Way Insertion Natural Nylon
3/4" Square Cable Tie Mount
With Adhesive



16054PK Use with # 6 Flat Head Screw **100 Pcs.**
Accepts 18 lb To 50 lb Ties
4 Way Insertion Natural Nylon
1" Square Cable Tie Mount
With Adhesive



G.M. Clips & Fasteners

Retainers Moulding

16093PK 23/64" (9mm) Hole Size **10 Pcs.**
10mm Stem Length
12 x 20mm
Green Nylon With Sealer
Moulding Retainers
G.M. # 11547210



Hyundai Clips & Fasteners

Rivets Automotive

16077PK 1/8" (3.20mm) Diameter **25 Pcs.**
6.30mm Flange Size
4.00mm-7.90mm Grip Range
Black Aluminum Rivet Steel Mandrel
Front & Rear Bumper Rivets
Hyundai # 14160-03133



Disco Automotive Hardware

Ph: 580-622-3090

Fax: 580-622-3781

discosales@discoautomotive.com

CNP61

10/15/21

COOL NEW PRODUCTS

Mercedes Clips & Fasteners

Retainers Moulding

16072PK

51/64" (20mm) Hole Size
16mm Stem Length
24mm Head Diameter
White Nylon
Rocker Moulding Retainers
Use With # 9587
Mercedes # 000-991-72-98

15 Pcs.

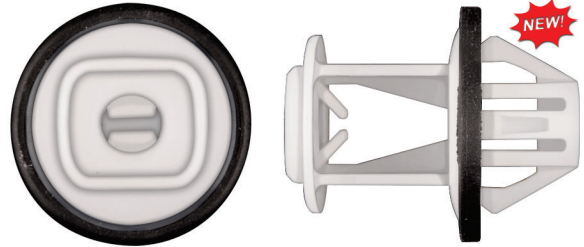

9587PK

1/4" (6.50mm) Hole Size
7mm Stem Length
31mm Slotted Head Diameter
Black Nylon
Rocker Moulding Retainers
Use With # 16072
Mercedes # 000-991-74-98

15 Pcs.

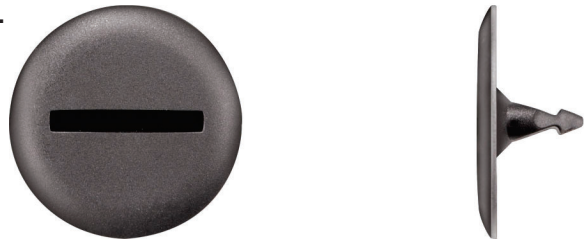

Nissan Clips & Fasteners

Retainers Weatherstrip

16067PK

15/64" (6mm) Hole Size
12mm Stem Length
7 x 16mm Head Size
Blue Nylon
Weatherstrip Retainers
Nissan # 01553-09311

25 Pcs.



Toyota Clips & Fasteners

Clips Retaining

16098PK

43mm Overall Length
39mm Overall Width
Black Nylon
Bumper to Fender
Liner Clips
Toyota # 53879-02150, 53879-33030

5 Pcs.



Disco Automotive Hardware

Ph: 580-622-3090

Fax: 580-622-3781

discosales@discoautomotive.com

CNP62

10/15/21

COOL NEW PRODUCTS

Chrysler Clips & Fasteners

Nuts Specialty

18265PK

6-1.00 Screw Size
10mm Stem Length
15mm Square Hole Size
14.50 x 21mm Head Size
Magni-554 Finish
Door & Fender Nuts
Chrysler # 6506955AA

10 Pcs.

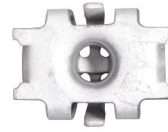

Nuts Extruded "U"

16079PK

6-1.00mm Screw Size
.80 - 4.00mm Panel Range
13.50mm Center of Hole to Edge
Zinc Organic
Extruded U Nut
Chrysler # 6510185-AA, 6101956, 6503694
Ford # W520822-S439

25 Pcs.



Retainers Push Type

18264PK

1/4" (6.30mm) Hole Size
14mm Stem Length
14mm Top Head Diameter
Black Nylon
Spoiler Retainers
Chrysler # 6502632

15 Pcs.



Retainer Door Trim Panel

16074PK

23/64"(9mm) Hole Size
13mm Stem Length
22mm Flange Diameter
Yellow & White Nylon
Door Panel Retainers
Chrysler # 6510766-AA

15 Pcs.



Retainers Moulding

18450PK

23/64" (9mm) Hole Size
12mm Stem Length
12mm Stem Length
14.50 x 38mm Top Head Size
White Nylon
Wheel Flare Retainers

10 Pcs.

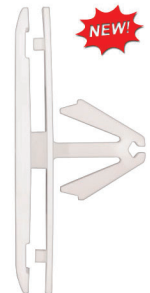

Disco Automotive Hardware

Ph: 580-622-3090

Fax: 580-622-3781

discosales@discoautomotive.com

CNP63

10/15/21

COOL NEW PRODUCTS

Sales Aids

Boards Sample

SB16023

Weatherstrip Retainers,
Nylon Nuts, Screw Grommets,
Door & Moulding Retainers,
Retaining Clips
Toyota Sample Board

Sold Each



SB16024

Extruded "U" Nuts,
Bumper Clips & Pins &
Hood, Shield,
Push & Screw Type Retainers
Toyota Sample Board

Sold Each

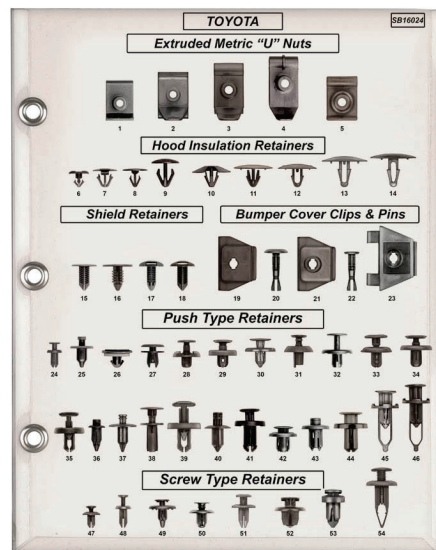

Disco Automotive Hardware

Ph: 580-622-3090

Fax: 580-622-3781

discosales@discoautomotive.com

CNP64

COOL NEW PRODUCTS

Sales Aids

Boards Sample

SB16025

Weatherstrip, Door &
Moulding Retainers,
Screw Grommets &
Nylon Nuts
Honda Sample Board

Sold Each

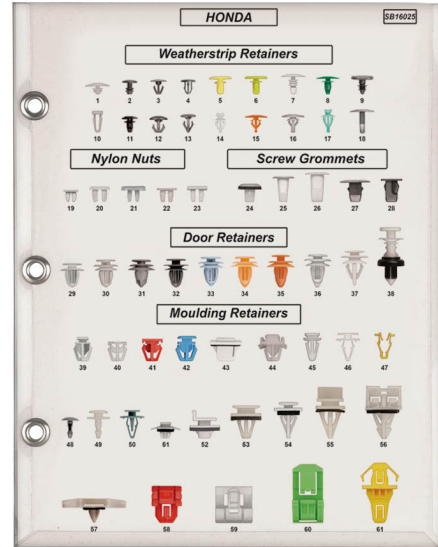

SB16026

Shield, Hood Insulation,
Push & Screw Retainers
Honda Sample Board

Sold Each

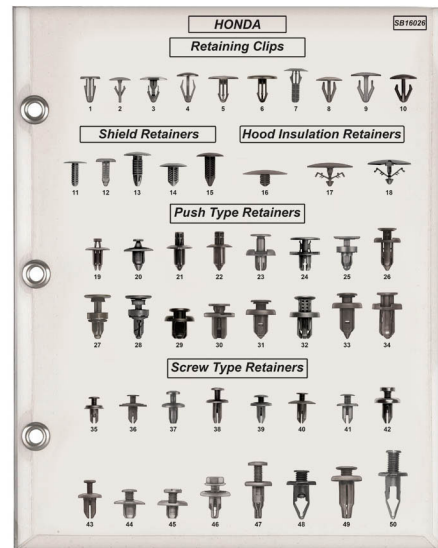

Disco Automotive Hardware

Ph: 580-622-3090

Fax: 580-622-3781

discosales@discoautomotive.com

CNP65

COOL NEW PRODUCTS

Sales Aids

Boards Sample

SB16027

Weatherstrip,
Nylon Nut,
Screw Grommet,
Door & Moulding Retainers
Nissan Sample Board

Sold Each



SB16028

Shield, Hood Insulation,
Screw & Push Type
Retainers
Nissan Sample Board

Sold Each

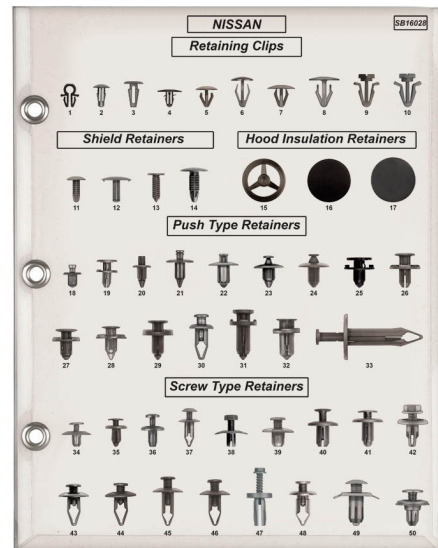

Disco Automotive Hardware

Ph: 580-622-3090

Fax: 580-622-3781

discosales@discoautomotive.com

CNP66

COOL NEW PRODUCTS

Sales Aids

Boards Sample

SB16029

Nylon Nuts, Door,
Moulding &
Weatherstrip Retainers
Ford Sample Board

Sold Each



SB16030

Push, Screw Type &
Hood Retainers
Ford Sample Board

Sold Each

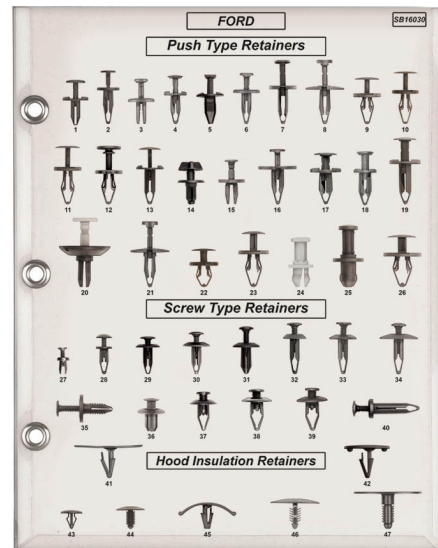

Disco Automotive Hardware

Ph: 580-622-3090

Fax: 580-622-3781

discosales@discoautomotive.com

CNP67

COOL NEW PRODUCTS

Sales Aids

Boards Sample

SB16031

Door & Moulding Retainers
Volkswagen Sample Board

Sold Each



SB16032

Nylon Nut,
Hood, Skid Plate,
Push & Screw Type
Retainers
Volkswagen Sample Board

Sold Each

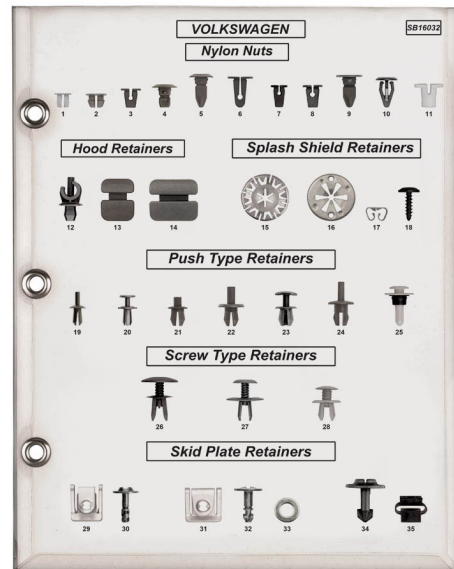

Disco Automotive Hardware

Ph: 580-622-3090

Fax: 580-622-3781

discosales@discoautomotive.com

CNP68

COOL NEW PRODUCTS

Sales Aids

Boards Sample

SB16033

Nut &
Screw Grommets,
Door, Moulding, Weatherstrip,
Push & Screw Type Retainers
Hyundai Sample Board

Sold Each

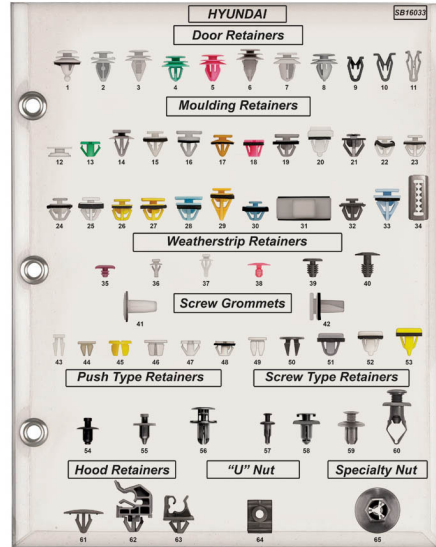

SB16034

Push On Type,
Shield & Weatherstrip
Retainers
Chrysler Sample Board

Sold Each

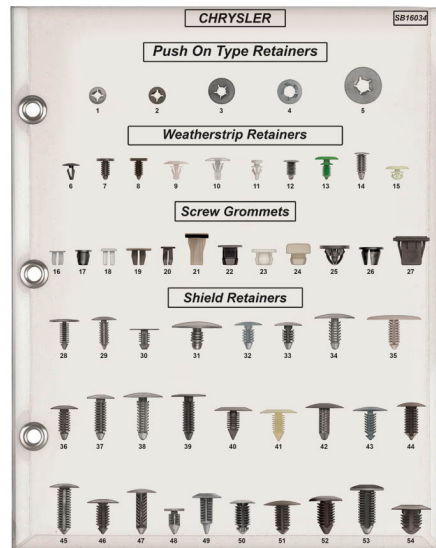

Disco Automotive Hardware

Ph: 580-622-3090

Fax: 580-622-3781

discosales@discoautomotive.com

CNP69

COOL NEW PRODUCTS

Sales Aids

Boards Sample

SB16035

Push & Screw Type,
Hood Retainers
Chrysler Sample Board

Sold Each

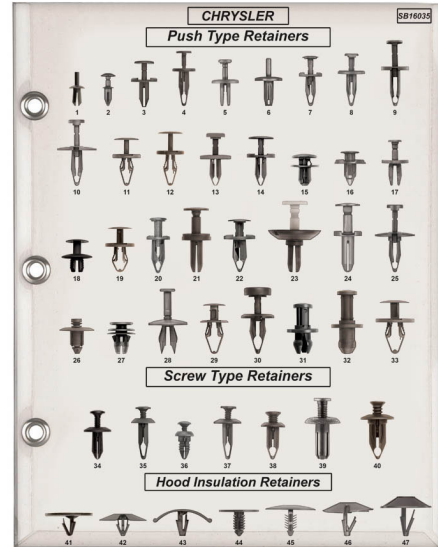

SB16036

Nutserts,
Door & Moulding
Retainers
Chrysler Sample Board

Sold Each

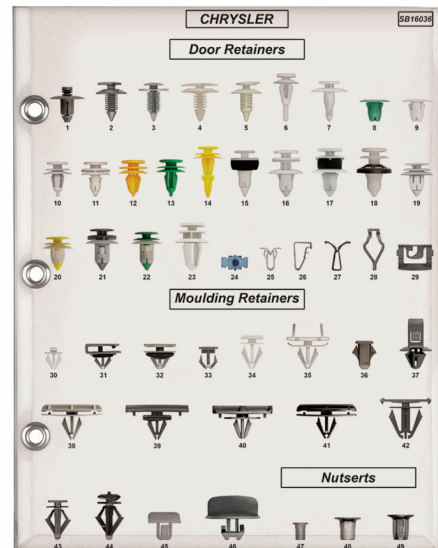

Disco Automotive Hardware

Ph: 580-622-3090

Fax: 580-622-3781

discosales@discoautomotive.com

CNP70

COOL NEW PRODUCTS

Sales Aids

Boards Sample

SB16037

Nuts,
Push On Type,
& Weatherstrip Retainers
General Motors Sample Board

Sold Each

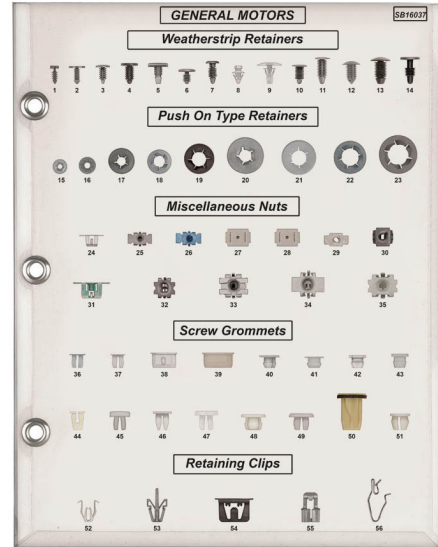

SB16038

Push Type Retainers
General Motors Sample Board

Sold Each



Disco Automotive Hardware

Ph: 580-622-3090

Fax: 580-622-3781

discosales@discoautomotive.com

CNP71

COOL NEW PRODUCTS

Sales Aids

Boards Sample

SB16039

Shield & Screw Type Retainers
General Motors Sample Board

Sold Each



SB16040

Door Panel Retainers
General Motors Sample Board

Sold Each



Disco Automotive Hardware

Ph: 580-622-3090

Fax: 580-622-3781

discosales@discoautomotive.com

CNP72

COOL NEW PRODUCTS

Sales Aids

Boards Sample

SB16041 Flange & Loose Washer
Hex Nuts, Nutserts,
Rubber Well Nuts,
Bushings & Hood Retainers
General Motors Sample Board

Sold Each

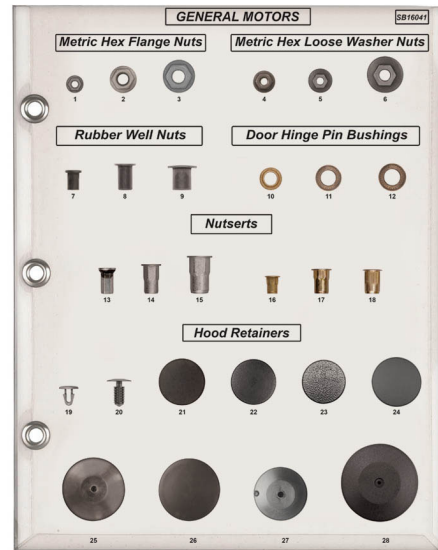

SB16042 Moulding Retainers
General Motors Sample Board

Sold Each



Disco Automotive Hardware

Ph: 580-622-3090

Fax: 580-622-3781

discosales@discoautomotive.com

CNP73

COOL NEW PRODUCTS

Sales Aids

Boards Sample

SB16043

1/2" to 1" O.D. &
11mm to 20mm O.D.
Oil Drain Gasket Sample Board

Sold Each



SB16044

1/2-20,
12-1.25mm, 12-1.75mm,
14-1.25mm, 14-1.50mm
Thread Sizes
Oil Drain Plug Sample Board

Sold Each

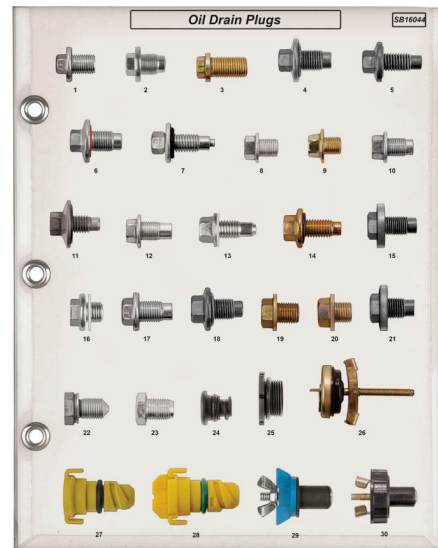

Disco Automotive Hardware

Ph: 580-622-3090

Fax: 580-622-3781

discosales@discoautomotive.com

CNP74

COOL NEW PRODUCTS

G.M. Clips & Fasteners

Retainers Grommets

16309PK

25/64" (10mm) Hole Size
17.50mm Overall Length
19mm Head Diameter
Orange Nylon With Sealer
Tail Lamp Grommets
G.M. # 84221533

10 Pcs.



Retainers Door Trim Panel

16311PK

1/4" (6.50mm) Hole Size
9.30mm Stem Length
15mm Flange Diameter
White Nylon With Sealer
Interior Door Trim &
Exterior Moulding Retainers
G.M. # 11610700

15 Pcs.



Ford Clips & Fasteners

Nuts Nylon

16308PK

15/64" (6.00mm) Screw Size
23mm Stem Length
15mm Square Head
10mm Hole Size
Gray Nylon With Sealer
License Plate Grommets
Ford # W714172-S300

15 Pcs.



Retainers Shield

16312PK

21/64" (8.50mm) Hole Size
63.50mm Stem Length
30mm Head Diameter
Gray Nylon
Headliner Retainers
Ford # W717918-SS34X

15 Pcs.

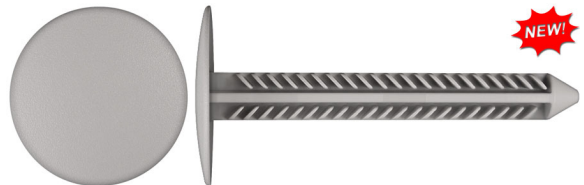

Not Actual Size



Retainers Push Type

16313PK

1/4" (6.30mm) Hole Size
18mm Stem Length
14mm Head Diameter
Black Nylon
Cowl Vent
Push Type Retainers
Ford # W703243-S300

10 Pcs.



Disco Automotive Hardware

Ph: 580-622-3090

Fax: 580-622-3781

discosales@discoautomotive.com

CNP75

COOL NEW PRODUCTS

Specialty Nuts

Nuts License Plate

9597PK

6-1.00mm Screw Size
Zinc Organic
License Plate Nuts
G.M. # 15707256

10 Pc.

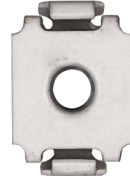

Assortments

Assortments Metric Hex Flange Bolt



Contains 24 Difernt Size
229 Total Pieces
6mm To 10mm Screw Size
Class 10.9 Hex Flange
Nuts & Bolts Assortment

BACK OF TRAY					
# 8716 Bright Zinc Finish 10.9 Grade Metric Hex Flange Bolt Assortment					
3200PK 6 - 1.00mm Class 10 10mm Hex, 14mm Serrated Flange Bright Zinc Finish Metric Spin Lock Nuts JIS B1189 1	3201PK 8 - 1.25mm Class 10 12mm Hex, 17mm Serrated Flange Bright Zinc Finish Metric Spin Lock Nuts JIS B1190 2	17946PK 10 - 1.50mm Class 10 15mm Hex, 21.3mm Serrated Flange Bright Zinc Finish Metric Spin Lock Nuts	3203PK 6 - 1.00 x 12mm Class 10.9 10mm Hex, 14mm Flange Bright Zinc Finish Metric Flange Bolts JIS B1189 3	3204PK 6 - 1.00 x 16mm Class 10.9 10mm Hex, 14mm Flange Bright Zinc Finish Metric Flange Bolts JIS B1189 4	17950PK 10 - 1.50 x 30mm Class 10.9 15mm Hex, 22.3mm Flange Bright Zinc Finish Metric Flange Bolts
3205PK 6 - 1.00 x 20mm Class 10.9 10mm Hex, 14mm Flange Bright Zinc Finish Metric Flange Bolts JIS B1189 7	3206PK 6 - 1.00 x 25mm Class 10.9 10mm Hex, 14mm Flange Bright Zinc Finish Metric Flange Bolts	3207PK 6 - 1.00 x 30mm Class 10.9 10mm Hex, 14mm Flange Bright Zinc Finish Metric Flange Bolts JIS B1189 9	3208PK 6 - 1.00 x 35mm Class 10.9 10mm Hex, 14mm Flange Bright Zinc Finish Metric Flange Bolts JIS B1189 10	3209PK 6 - 1.00 x 40mm Class 10.9 10mm Hex, 14mm Flange Bright Zinc Finish Metric Flange Bolts JIS B1189 11	17951PK 10 - 1.50 x 35mm Class 10.9 15mm Hex, 22.3mm Flange Bright Zinc Finish Metric Flange Bolts
9824PK 6 - 1.00 x 45mm Class 10.9 10mm Hex, 14mm Flange Bright Zinc Finish Metric Flange Bolts JIS B1189 13	3210PK 8 - 1.25 x 12mm Class 10.9 12mm Hex, 17.50mm Flange Bright Zinc Finish Metric Flange Bolts JIS B1189 14	3211PK 8 - 1.25 x 16mm Class 10.9 12mm Hex, 17.50mm Flange Bright Zinc Finish Metric Flange Bolts JIS B1189 15	3212PK 8 - 1.25 x 20mm Class 10.9 12mm Hex, 17.50mm Flange Bright Zinc Finish Metric Flange Bolts JIS B1189 16	3213PK 8 - 1.25 x 25mm Class 10.9 12mm Hex, 17.50mm Flange Bright Zinc Finish Metric Flange Bolts JIS B1189 17	17952PK 10 - 1.50 x 40mm Class 10.9 15mm Hex, 22.3mm Flange Bright Zinc Finish Metric Flange Bolts
3214PK 8 - 1.25 x 30mm Class 10.9 12mm Hex, 17.50mm Flange Bright Zinc Finish Metric Flange Bolts JIS B1189 19	3215PK 8 - 1.25 x 35mm Class 10.9 12mm Hex, 17.50mm Flange Bright Zinc Finish Metric Flange Bolts JIS B1189 20	3216PK 8 - 1.25 x 40mm Class 10.9 12mm Hex, 17.50mm Flange Bright Zinc Finish Metric Flange Bolts JIS B1189 21	17948PK 10 - 1.50 x 20mm Class 10.9 15mm Hex, 22.3mm Flange Bright Zinc Finish Metric Flange Bolts	17949PK 10 - 1.50 x 25mm Class 10.9 15mm Hex, 22.3mm Flange Bright Zinc Finish Metric Flange Bolts	17953PK 10 - 1.50 x 45mm Class 10.9 15mm Hex, 22.3mm Flange Bright Zinc Finish Metric Flange Bolts
FRONT OF TRAY					



Part #	Tray Type	Material	Tray #	Tray Color	Lid Color	Label Type	Clear Pocket	Qty.	
8716	24 Hole	Plastic	80123	Gray	Gray	Adhesive	No	1 Pc.	NEW
8716BCP	24 Hole	Plastic	80155BCP	Dark Blue	Clear	Paper	Yes	1 Pc.	NEW
8716GCP	24 Hole	Plastic	80123GCP	Gray	Clear	Paper	Yes	1 Pc.	NEW
8716RCP	24 Hole	Plastic	80152RCP	Red	Clear	Paper	Yes	1 Pc.	NEW
8716YCP	24 Hole	Plastic	80123YCP	Yellow	Clear	Paper	Yes	1 Pc.	NEW

Disco Automotive Hardware

Ph: 580-622-3090

Fax: 580-622-3781

discosales@discoautomotive.com

CNP76

COOL NEW PRODUCTS

Specialty Nuts

Nuts Emblem

18451PK

5mm Stud Size
10mm Hex Size
15mm Flange Diameter
Zinc Finish
Locking Teeth
Emblem Nuts
Ford # W706675-S439

50 Pcs.



Nuts Hex Loose Washer Metric

12055PK

6 - 1.00mm Screw Size
11mm Hex Size
24mm O.D. Loose Washer
Yellow Zinc Finish
Metric Hex Nuts
Ford # N621907, N621907-S55

25 Pcs.



Nuts Keps®



Part #	Thread Size	Hex Size	Finish	Qty.	
16133PK	6-32	5/16"	Zinc	100 Pcs.	New
16134PK	8-32	11/32"	Zinc	100 Pcs.	New
16135PK	10-24	3/8"	Zinc	100 Pcs.	New
16136PK	10-32	3/8"	Zinc	100 Pcs.	New
16137PK	12-24	7/16"	Zinc	100 Pcs.	New
16138PK	1/4-20	7/16"	Zinc	100 Pcs.	New
16140PK	3/8-16	9/16"	Zinc	100 Pcs.	New
16139PK	5/16-18	1/2"	Zinc	100 Pcs.	New

Nuts Extruded "U" Type Metric

16075PK

8-1.25mm Screw Size
.80mm-4.00mm Panel Range
14.50mm Center of Hole to Edge
Zinc Finish
Extruded "U" Nuts
Ford # W520823-S439, N800296-S439

15 Pcs.



Disco Automotive Hardware

Ph: 580-622-3090

Fax: 580-622-3781

discosales@discoautomotive.com

CNP77

COOL NEW PRODUCTS

Specialty Nuts

Hex Nuts

11896PK 6-1.00mm Screw Size
11mm Hex Size
19mm O.D. Loose Washer
Black Finish
Metric Hex Nuts
G.M. # 11503754, 11503756, 11505005,
11517293, 11609411

25 Pcs.

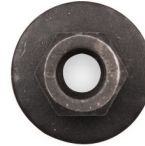

Nuts Extruded Type "U" Metric

11981PK #8 (4.2-1.41) Screw Size
1.80mm-3.50mm Panel Range
9.50mm Center of Hole to Edge
Zinc Organic
Metric "U" Nuts
Ford # W716567-S439

25 Pcs.



16095PK 6 - 1.00mm Screw Size
.50mm - 4.00mm Panel Range
13mm Center of Hole to Edge
Silver Finish
Extruded "U" Nuts
Chrysler # 6105242-AA

25 Pcs.

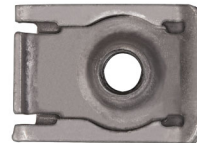

Service Equipment

Storage Bins, Stand



80378



80383

Part #	Width	Depth	Height	Finish	Use With	Qty.	
80378	33 3/4"	12 1/4"	5 3/4"	Gray	# 80372 & 80375	1 Pc.	NEW
80383	33 3/4"	12 1/4"	12"	Gray	# 80372 & 80375	1 Pc.	NEW

Disco Automotive Hardware

Ph: 580-622-3090

Fax: 580-622-3781

discosales@discoautomotive.com

CNP78

COOL NEW PRODUCTS

Screws

Screws Phillips Hex Head Sems®

11867PK 5-1.59 x 16mm
8mm Indented Hex Head
16mm O.D. Loose Washer
Black Finish
Phillips Sems® Screws



Screw Phillips Oval Loose Washer Head Sems® Trim

5764PK 10 x 5/8" # 8 Head
Phillips Oval Loose Washer
15/32" O.D. Washer
Chrome Finish
Sems® Trim Screws



G.M. Clips & Fasteners

























Clips Moulding

16310PK 8mm Width
15mm Height
White Nylon
Quarter Panel &
Exterior Trim Moulding Clips
Ford # W714972-S300
GM # 94748652



Assortments

Assortment G.M. Specialty Nut

# 8219 G.M. Specialty Nut Assortment					
# 9199PK  #8 Screw Size Zinc Finish Aluminum Steel Radiator Grille Nuts 	# 11032PK  #8 (4.20mm) Screw Size .70mm-2.30mm Panel Range 8.70mm Hole Size Blue Finish MFI Panel Nuts 	# 12983PK  #8 (4.20mm) Screw Size 6mm x 16mm Head Size 7mm Overall Height Magni-565 Finish Front Bumper Nuts 	# 11258PK  #8 (4.20mm) Screw Size 8.65mm Hole Size Zinc Finish Fender Bracket Push In Nuts 	# 10143PK  17/32" (13.50mm) Hole Size 11mm Overall Length Headlamp Assembly Nuts 	# 16065PK  #8 (4.20mm) Screw Size 0.5mm-1.00mm Panel Range 8.55mm Square Hole Size Green Finish W/Silicone Pad Door Panel & Bumper Nuts 
# 11034PK  #8 (4.20mm) Screw Size 9 x 11mm Hole Size Black Finish Dash Panel Nuts 	# 18094PK  6-1.00 Screw Size .70mm-3.80mm Panel Range 9.25 x 13.75mm Hole Size Zinc Finish Rear Bumper Bracket Nuts 	# 15691PK  4.2-1.41 #8 Screw Size Zinc Organic Center Console Door, Front Lights, Grille, Lift Gate Nuts W/Silicone Pad 	# 15902PK  6-1.00mm Screw Size 12mm O.A. Height Organic Zinc Finish Front Fender Panel Nuts 	# 15864PK  4.2 x 1.41 Screw Size 10.90 x 13mm Hole Size 1.40-5mm Panel Range Green Metallic Finish Bracket Retainer Nuts 	# 13423PK  6-1.00 Thread Size 11mm O.A. Height Zinc Organic Radiator Grille & Front End Panel Nuts 



8219 Contains 12 Different Sizes
180 Total Pieces
6 3/4" x 11" Plastic Tray
Used on G.M. Cars & Trucks
Specialty Nut Assortment

1 Pc.

Disco Automotive Hardware

Ph: 580-622-3090

Fax: 580-622-3781

discosales@discoautomotive.com

CNP79

COOL NEW PRODUCTS

Specialty Nuts

Nuts Miscellaneous

16065PK #8 (4.20mm) Screw Size
.50mm-1.00mm Panel Range
8.55mm Square Hole Size
Green Finish W/Silicone Pad
Door Panel & Bumper Nuts
G.M. # 11546868

15 Pcs.



16314PK 6-1.00 Screw Size
9/16" (14mm) Square Hole
16.25mm Overall Length
Black Finish Bumper,
Door Glass & Grille Nuts
Chrysler # 6505223AA

10 Pcs.



Hole Plug

Hole Plugs Locking Type Black

16325PK 1 1/2" Hole Size
1 43/64" Head Diameter
1/8" Max Panel Thickness
Black Nylon Flush Type
Locking Hole Plugs

25 Pcs.



Retainers Windshield & Cowl

Clips Windshield Moulding

16307PK 43mm Overall Height
18mm Overall Width
White & Black Nylon
Windshield & Interior Trim
Moulding Clips
Honda # 91561-TV1-E11

50 Pcs.

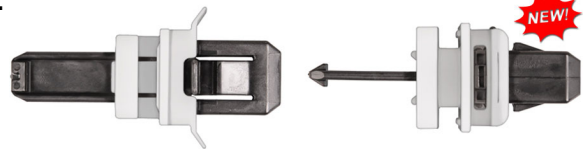

Not Actual Size

Disco Automotive Hardware

Ph: 580-622-3090

Fax: 580-622-3781

discosales@discoautomotive.com

CNP80

COOL NEW PRODUCTS

Specialty Nuts

Nuts Extruded "U"

16328PK

6-1.00 Screw Size
0.70mm-2.00mm Panel Range
12mm Center of Hole to Edge
Zinc Finish
Speed Type "U" Nuts
Ford # W712324-S439

10 Pcs.



Nuts Nylon

16359PK

4mm Screw Size
1 1/32" (8.50mm) Hole Size
9.70mm Stem Length
9.50mm Head Size
Gray Nylon With Sealer
Screw Grommets
Honda # 90656-SJK-J01

15 Pcs.



Sales Aids

Display Poster Wall

1EDP

Oil Drain Hardware
Displayed on a 28" x 40"
English Wall Poster

Sold Each

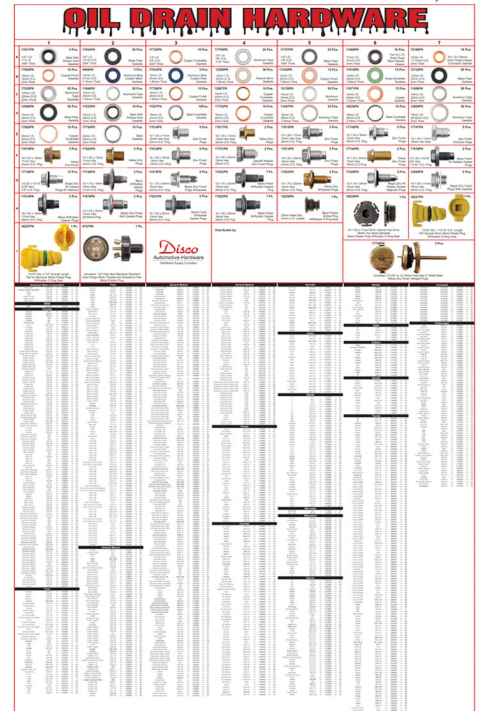

Disco Automotive Hardware

Ph: 580-622-3090

Fax: 580-622-3781

discosales@discoautomotive.com

CNP81

COOL NEW PRODUCTS

Specialty Nuts

Nuts Extruded Type "U" Metric

16365PK

6-1.00 Screw Size
1.80mm - 2.20mm Panel Range
9.20mm Center of Hole to Edge
Zinc Organic
Extruded "U" Nuts
Chrysler # 68073566AA

15 Pcs.



Door Fasteners

Retainers Door Trim Panel

16358PK

11/32" (8.50mm) Hole Size
21.10mm Flange Diameter
24.10mm Overall Length
Black Nylon With Sealer
Tailgate Spoiler Retainers
Honda # 91513-T6A-003

15 Pcs.



16363PK

23/64" (9mm) Hole Size
18.50mm Stem Length
16mm Top Head Size
Black & White Nylon
Door Panel Retainers
Chrysler # 6510359AA

15 Pcs.



16362PK

23/64" (9mm) Hole Size
18.50mm Stem Length
16mm Top Head Size
Black & Yellow Nylon
Door Panel Retainers
Chrysler # 6510747AA

15 Pcs.



Ford Clips & Fasteners

Retainers Push Type

15015PK

3/8" (9.50mm) Hole Size
11mm Stem Length
14 x 40mm Head Size
Black Nylon
Rocker Moulding Retainers
Ford # F57Z-16241-AB, W709767-S300

15 Pcs.



Disco Automotive Hardware

Ph: 580-622-3090

Fax: 580-622-3781

discosales@discoautomotive.com

CNP82