

# COOL NEW PRODUCTS

## # 8808



## Oil Drain Plug & Gasket Assortment

BACK OF TRAY							
# 8808 Oil Drain Plug & Gasket Assortment							
17618PK  1/2" .20 x 13/16" 5/8" Hex Size 1.332" O.D. Flange Size Black Finish W/ Rubber Gasket, Oil Drain Plugs	17614PK  12-1.25 x 11mm 14mm Hex Size 20mm O.D. Flange Size Zinc Finish Oil Drain Plugs	17617PK  12-1.25 x 12mm 14mm Hex Size 32mm O.D. Flange Size Yellow Zinc Oil Drain Plugs	17615PK  12-1.25 x 17mm 14mm Hex Size 20mm O.D. Flange Size Zinc Finish Oil Drain Plugs	17623PK  12-1.75 x 25mm 13mm Hex Size 26mm O.D. Flange Black Finish W/Rubber Gasket, Oil Drain Plugs	11972PK  12mm-1.75 x 26mm 15mm Hex Size 22mm O.D. Flange Size Bright Zinc Finish Oil Drain Plugs W/Gasket	17620PK  12-1.75 x 30mm 13mm Hex Size 26mm O.D. Flange Bright Zinc W/Rubber Gasket, Magnetic Oil Drain Plugs	17616PK  14-1.50 x 10mm 17mm Hex Size 24mm O.D. Flange Size Yellow Zinc Finish Oil Drain Plug
17625PK  12-1.75 x 25mm 15mm Hex Size 26mm O.D. Flange Size Yellow Zinc W/Gasket Oil Drain Plug	17624PK  14-1.50 x 15mm 17mm Hex Size 24mm O.D. Flange Size Yellow Zinc Oil Drain Plug	17612PK  14-1.50 x 16mm 13mm Hex Size 23mm O.D. Flange Size Zinc Finish Oil Drain Plug	17613PK  14-1.50 x 20 mm 16mm Hex Size 25mm O.D. Flange Size Zinc Finish Oil Drain Plug	17622PK  14-1.50 x 20mm 16mm Hex Size 28mm O.D. Flange Black Finish W/Rubber Gasket, Oil Drain Plugs	17621PK  14-1.50 x 20mm 13mm Hex Size 28mm O.D. Flange Size Black Finish W/Rubber Gasket, Oil Drain Plugs	11970PK  14-1.50 x 20mm 13mm Hex Size 28.5mm O.D. Flange Size Bright Zinc Finish W/Gasket, Oil Drain Plug	17744PK  14-1.50 x 24mm 13mm Hex Size 19mm O.D. Flange Size Yellow Zinc Finish Oil Drain Plugs
17634PK  1/2" Inside Diameter 15/16" Outside Diameter 5/64" Thickness Black Fiber Oil Drain Plug Gaskets	17631PK  1/2" Inside Diameter 1" Outside Diameter 3/64" Thickness Steel With Rubber Seal Oil Drain Plug Gaskets	11969PK  11mm I.D., 21mm O.D. 3mm Thickness For 12-1.75 Drain Plugs Black Rubber Oil Drain Plug Gaskets	17626PK  12mm Inside Diameter 18mm Outside Diameter 2mm Thickness Copper Finish Oil Drain Plug Gaskets	9994PK  12mm I.D., 21mm O.D. 1.75mm Thickness Blue Coated Aluminum & Fibre Oil Plug Gaskets	17630PK  12mm Inside Diameter 22mm Outside Diameter 1.50mm Thickness Copper Finish Oil Drain Plug Gaskets	12134PK  12mm Inside Diameter 22mm Outside Diameter 2mm Thickness Black Fiber Oil Drain Gaskets	17629PK  12mm Inside Diameter 22mm Outside Diameter 2mm Thickness Aluminum Type Oil Drain Plug Gaskets
12097PK  14mm Inside Diameter 20mm Outside Diameter 2mm Thickness Copper Crushable Oil Drain Plug Gaskets	15138PK  14mm Inside Diameter 20mm Outside Diameter 2mm Thickness Aluminum Type Oil Drain Plug Gaskets	11971PK  14mm Inside Diameter 22mm Outside Diameter 1.5mm Thickness Copper Oil Drain Plug Gaskets	11999PK  14mm Inside Diameter 22mm Outside Diameter 2mm Thickness Aluminum Type Oil Drain Plug Gaskets	12096PK  14mm Inside Diameter 24mm Outside Diameter 2mm Thickness Black Fiber Oil Drain Plug Gaskets	17632PK  14mm Inside Diameter 25mm Outside Diameter 1.00mm Thickness Steel With Rubber Seal Oil Drain Plug Gaskets	17627PK  16mm Inside Diameter 21mm Outside Diameter 2mm Thickness Steel Crushable Oil Drain Plug Gaskets	17754PK  20mm Inside Diameter 28mm Outside Diameter 2mm Thickness Steel Finish Oil Drain Plug Gaskets
FRONT OF TRAY							

Contains 32 Different Sizes  
224 Total Pieces  
Adjustable Gray Plastic Tray  
Oil Drain Plug &  
Gasket Assortment



Part #	Tray Type	Material	Tray #	Tray Color	Lid Color	Label Type	Clear Pocket	Qty.	
8808	Adjustable	Plastic	80132	Gray	Gray	Adhesive	No	1 Pc.	NEW
8808BCP	Adjustable	Plastic	80156BC	Dark Blue	Clear	Paper	Yes	1 Pc.	NEW
8808GCP	Adjustable	Plastic	80132GC	Gray	Clear	Paper	Yes	1 Pc.	NEW
8808RCP	Adjustable	Plastic	80153RC	Red	Clear	Paper	Yes	1 Pc.	NEW
8808YCP	Adjustable	Plastic	80132YC	Yellow	Clear	Paper	Yes	1 Pc.	NEW

**Disco** Automotive Hardware

Ph: 580-622-3090

Fax: 580-622-3781

discosales@discoautomotive.com

CNP1

# COOL NEW PRODUCTS

## # 8809



## Oil Drain Plug Assortment

BACK OF TRAY																							
# 8809																							
Oil Drain Plug Assortment																							
17736PK		1/2-20 x 13/16" 9/16" Hex Size 7/8" O.D. Flange Size Bright Zinc Finish Oil Drain Plugs	1	17614PK		12-1.25 x 11mm 14mm Hex Size 20mm O.D. Flange Size Zinc Finish Oil Drain Plugs	2	17617PK		12-1.25 x 12mm 14mm Hex Size 32mm O.D. Flange Size Yellow Zinc Oil Drain Plugs	3	17615PK		12-1.25 x 17mm 14mm Hex Size 20mm O.D. Flange Size Zinc Finish Oil Drain Plugs	4	17623PK		12-1.75 x 25mm 13mm Hex Size 26mm O.D. Flange Black Finish W/Rubber Gasket Oil Drain Plugs	5	17618PK		1/2" - 20 x 13-16" 14mm Hex Size 1-3/32" O.D. Flange Size Black Finish W/Rubber Gasket Oil Drain Plugs	6
11972PK		12mm-1.75 x 26mm 15mm Hex Size 22mm O.D. Flange Size Bright Zinc Finish Oil Drain Plugs W/ Gasket	7	17620PK		12-1.75 x 30mm 13mm Hex Size 26mm O.D. Flange Bright Zinc W/Rubber Gasket Oil Drain Plugs	8	17616PK		14-1.50 x 10mm 17mm Hex Size 24mm O.D. Flange Size Yellow Zinc Finish Oil Drain Plug	9	12095PK		14-1.50 x 11mm 16mm Hex Size 25mm O.D. Flange Size Bright Zinc Finish Oil Drain Plug With Gasket	10	17624PK		14-1.50 x 15mm 17mm Hex Size 24mm O.D. Flange Size Yellow Zinc Finish Oil Drain Plugs	11	17746PK		12-1.75 x 19mm 14mm Hex Size 31mm O.D. Flange Size Black W/Rubber Gasket Oil Drain Plug	12
17745PK		14-1.25 x 16mm 13mm Hex Size 23mm O.D. Flange Size Zinc Finish Oil Drain Plug	13	17747PK		14-1.25 x 17mm 19mm Hex Size Zinc Finish Oversize Oil Drain Plug	14	17612PK		14-1.50 x 16mm 13mm Hex Size 23mm O.D. Flange Size Zinc Finish Oil Drain Plug	15	17619PK		14-1.50 x 18mm 17mm Hex Size 28mm O.D. Flange Size Black Finish W/Rubber Gasket Oil Drain Plug	16	17613PK		14-1.50 x 20mm 16mm Hex Size 25mm O.D. Flange Size Zinc Finish Oil Drain Plug	17	17625PK		12-1.75 x 25mm 15mm Hex Size 26mm O.D. Flange Size Yellow Zinc With Gasket Oil Drain Plug	18
17622PK		14-1.50 x 20mm 16mm Hex Size 28mm O.D. Flange Black Finish W/Rubber Gasket Oil Drain Plugs	19	17621PK		14-1.50 x 20mm 13mm Hex Size 28mm O.D. Flange Black Finish W/Rubber Gasket Oil Drain Plugs	20	11970PK		14-1.50 x 20mm 13mm Hex Size 28.5mm O.D. Flange Size Bright Zinc Finish Oil Drain Plug With Gasket	21	17744PK		14-1.50 x 24mm 19mm O.D. Flange Size Yellow Zinc Finish Oil Drain Plugs	22	17751PK		14-1.50 x 20mm 19mm Hex Size 20mm O.D. Sems® Washer Zinc Finish Oil Drain Plugs	23	17749PK		1/2-3/4" or 12-18mm Hole Size 2" Shaft Length Steel Yellow Zinc Finish Universal Winged Oil Drain Plugs	24

FRONT OF TRAY

Contains 24 Different Sizes  
 96 Total Pieces  
 1/2-20, 12x1.25, 12x1.75  
 14x1.25, 14x1.50 Hole Sizes  
 Oil Drain Plug Assortment



Part #	Tray Type	Material	Tray #	Tray Color	Lid Color	Label Type	Clear Pocket	Qty.	
8809	24 Hole	Plastic	80123	Gray	Gray	Adhesive	No	1 Pc.	NEW
8809BCP	24 Hole	Plastic	80155BC	Dark Blue	Clear	Paper	Yes	1 Pc.	NEW
8809GCP	24 Hole	Plastic	80123GC	Gray	Clear	Paper	Yes	1 Pc.	NEW
8809RCP	24 Hole	Plastic	80152RC	Red	Clear	Paper	Yes	1 Pc.	NEW
8809YCP	24 Hole	Plastic	80123YC	Yellow	Clear	Paper	Yes	1 Pc.	NEW

**Disco** Automotive Hardware

Ph: 580-622-3090

Fax: 580-622-3781

discosales@discoautomotive.com

CNP2

# COOL NEW PRODUCTS

## # 8810



## Oil Drain Gasket Assortment

BACK OF TRAY							
# 8810							
Oil Drain Gasket Assortment							
17634PK 1 1/2" Inside Diameter 15/16" Outside Diameter 5/64" Thickness Black Fiber Oil Drain Plug Gaskets 1	17752PK 1/2" Inside Diameter 3/4" Outside Diameter 5/64" Thickness Copper Crushable Oil Drain Gaskets 2	17757PK 1/2" Inside Diameter 7/8" Outside Diameter 7/64" Thickness Black Fiber Oil Drain Gaskets 3	17755PK 1/2" Inside Diameter 7/8" Outside Diameter 1/16" Thickness Aluminum Type Oil Drain Gaskets 4	17631PK 1 1/2" Inside Diameter 1" Outside Diameter 3/64" Thickness Steel With Rubber Seal Oil Drain Plug Gaskets 5	11969PK 11mm I.D. 21mm O.D. 3mm Thickness For 12-1.75 Drain Plugs Black Rubber Oil Drain Plug Gaskets 6	17910PK 12mm Inside Diameter 22mm Outside Diameter 1.6mm Thickness Green Synthetic Oil Drain Plug Gaskets 7	12188PK 12mm I.D. 17.7mm O.D. 3mm Thickness For 12-1.25mm Oil Drain Plugs Copper Crushable Oil Drain Plug Gaskets 8
17626PK 12mm Inside Diameter 18mm Outside Diameter 2mm Thickness Copper Finish Oil Drain Plug Gaskets 9	9994PK 12mm I.D. 21mm O.D. 1.75mm Thickness Blue Coated Aluminum & Fiber Oil Plug Gaskets 10	12590PK 12mm Inside Diameter 22mm Outside Diameter 1.50mm Thickness Natural Nylon Oil Drain Gaskets 11	17633PK 12mm Inside Diameter 21mm Outside Diameter 1.80mm Thickness Blue Coated Aluminum & Fiber Oil Drain Plug Gaskets 12	17630PK 12mm Inside Diameter 22mm Outside Diameter 1.50mm Thickness Copper Finish Oil Drain Plug Gaskets 13	12134PK 12mm Inside Diameter 22mm Outside Diameter 2mm Thickness Black Fiber Oil Drain Gaskets 14	17629PK 12mm Inside Diameter 22mm Outside Diameter 2mm Thickness Aluminum Type Oil Drain Plug Gaskets 15	17756PK 14mm Inside Diameter 20mm Outside Diameter 1.50mm Thickness Copper Finish Oil Drain Plug Gaskets 16
11846PK 14mm Inside Diameter 20mm Outside Diameter 1.50mm Thickness Aluminum Type Oil Drain Plug Gaskets 17	15138PK 14mm Inside Diameter 20mm Outside Diameter 2mm Thickness Aluminum Type Oil Drain Plug Gaskets 18	12097PK 14mm Inside Diameter 20mm Outside Diameter 2mm Thickness Copper Crushable Oil Drain Plug Gaskets 19	11971PK 14mm Inside Diameter 22mm Outside Diameter 1.50mm Thickness Copper Oil Drain Plug Gaskets 20	11999PK 14mm Inside Diameter 22mm Outside Diameter 2mm Thickness Aluminum Type Oil Drain Plug Gaskets 21	12096PK 14mm Inside Diameter 24mm Outside Diameter 2mm Thickness Black Fiber Oil Drain Plug Gaskets 22	17632PK 14mm Inside Diameter 25mm Outside Diameter 1.00mm Thickness Steel With Rubber Seal Oil Drain Plug Gaskets 23	17627PK 16mm Inside Diameter 21mm Outside Diameter 2mm Thickness Steel Crushable Oil Drain Plug Gaskets 24
17753PK 16mm Inside Diameter 22mm Outside Diameter 2mm Thickness Copper Finish Oil Drain Plug Gaskets 25	11847PK 18mm Inside Diameter 20mm Outside Diameter 1.50mm Thickness Aluminum Type Oil Drain Plug Gaskets 26	12000PK 18mm Inside Diameter 25.50mm Outside Diameter 2mm Thickness Aluminum Type Oil Drain Plug Gaskets 27	17628PK 20mm Inside Diameter 26mm Outside Diameter 2mm Thickness Copper Crushable Oil Drain Plug Gaskets 28	17754PK 20mm Inside Diameter 26mm Outside Diameter 2mm Thickness Steel Finish Oil Drain Plug Gaskets 29			
FRONT OF TRAY							

Contains 29 Different Sizes  
290 Total Pieces  
1/2", 11mm, 12mm, 14mm  
Oil Drain Gasket Assortment



Part #	Tray Type	Material	Tray #	Tray Color	Lid Color	Label Type	Clear Pocket	Qty.	
8810	Adjustable	Plastic	80132	Gray	Gray	Adhesive	No	1 Pc.	NEW
8810BCP	Adjustable	Plastic	80156BC	Dark Blue	Clear	Paper	Yes	1 Pc.	NEW
8810GCP	Adjustable	Plastic	80132GC	Gray	Clear	Paper	Yes	1 Pc.	NEW
8810RCP	Adjustable	Plastic	80153RC	Red	Clear	Paper	Yes	1 Pc.	NEW
8810YCP	Adjustable	Plastic	80132YC	Yellow	Clear	Paper	Yes	1 Pc.	NEW

**Disco** Automotive Hardware

Ph: 580-622-3090

Fax: 580-622-3781

discosales@discoautomotive.com

CNP3

# COOL NEW PRODUCTS

## # 8811



### Self Piercing Rivet (SPR) Assortment

BACK OF TRAY					
# 8811 Self Piercing Rivet (SPR) Assortment					
18121PK 3.35 x 3.5mm Silver Steel H4 ALMAC Self Piercing Rivets (SPR) 1	18122PK 3.35 x 4.0mm Silver Steel H4 ALMAC Self Piercing Rivets (SPR) 2	18123PK 3.35 x 5.0mm Silver Steel H4 ALMAC Self Piercing Rivets (SPR) 3	18124PK 3.35 x 6.0mm Silver Steel H4 ALMAC Self Piercing Rivets (SPR) 4	18125PK 5.3 x 4.0mm Silver Steel H4 ALMAC Self Piercing Rivets (SPR) 5	18219 Removes 5.30mm Diameter Self Piercing Rivets Uses a Grade 8 Bolt Heavy Duty 6
7	18126PK 5.3 x 5.0mm Silver Steel H4 ALMAC Self Piercing Rivets (SPR) 8	18127PK 5.3 x 6.0mm Silver Steel H4 ALMAC Self Piercing Rivets (SPR) 9	18128PK 5.3 x 6.5mm Silver Steel H4 ALMAC Self Piercing Rivets (SPR) 10	18129PK 5.3 x 7.0mm Silver Steel H4 ALMAC Self Piercing Rivets (SPR) 11	12
18130PK 5.3 x 7.5mm Silver Steel H4 ALMAC Self Piercing Rivets (SPR) 13	18131PK 5.3 x 8.0mm Silver Steel H4 ALMAC Self Piercing Rivets (SPR) 14	18132PK 5.3 x 9.0mm Silver Steel H4 ALMAC Self Piercing Rivets (SPR) 15	16	17	18220 Installs 5.30mm Diameter Self Piercing Rivets Uses a Grade 8 Bolt Heavy Duty SPR Installs Tool 18
19	13328PK 1/4" (6.30mm) Diameter 1/2" Flange Size .060" - .138" Grip Range F-150 Trucks With Alum. Body All Steel Pop Rivets 20	12623PK 1/4" (6.30mm) Diameter 1/2" Flange Size .110" - .189" Grip Range F-150 Trucks With Alum. Body All Steel Pop Rivets 21	12625PK 1/4" (6.30mm) Diameter 1/2" Flange Size .189" - .238" Grip Range F-150 Trucks With Alum. Body All Steel Pop Rivets 22	13329PK 1/4" (6.30mm) Diameter 1/2" Flange Size .268" - .346" Grip Range F-150 Trucks With Alum. Body All Steel Pop Rivets 23	24
FRONT OF TRAY					

Contains 12 Different SPR  
 Contains 4 Different Pop Rivets  
 1,160 Total Rivets  
 1 Extraction & 1 Insertion Tool  
 Self Piercing Rivet Assortment



Part #	Tray Type	Material	Tray #	Tray Color	Lid Color	Label Type	Clear Pocket	Qty.	
8811	24 Hole	Plastic	80123	Gray	Gray	Adhesive	No	1 Pc.	NEW
8811BCP	24 Hole	Plastic	80155BC	Dark Blue	Clear	Paper	Yes	1 Pc.	NEW
8811GCP	24 Hole	Plastic	80123GC	Gray	Clear	Paper	Yes	1 Pc.	NEW
8811RCP	24 Hole	Plastic	80152RC	Red	Clear	Paper	Yes	1 Pc.	NEW
8811YCP	24 Hole	Plastic	80123YC	Yellow	Clear	Paper	Yes	1 Pc.	NEW

**Disco** Automotive Hardware

Ph: 580-622-3090

Fax: 580-622-3781

discosales@discoautomotive.com

CNP4

# COOL NEW PRODUCTS

## Assortments

### Rivets Self Piercing (SPR)

# 8214 Self Piercing Rivet Assortment					
<b># 18121PK</b>  3.35 x 3.50mm Silver Steel H4 ALMAC Self Piercing Rivets	<b># 18122PK</b>  3.35 x 4.00mm Silver Steel H4 ALMAC Self Piercing Rivets	<b># 18123PK</b>  3.35 x 5.00mm Silver Steel H4 ALMAC Self Piercing Rivets	<b># 18124PK</b>  3.35 x 6.00mm Silver Steel H4 ALMAC Self Piercing Rivets	<b># 18125PK</b>  5.30 x 4.00mm Silver Steel H4 ALMAC Self Piercing Rivets	<b># 18126PK</b>  5.30 x 5.00mm Silver Steel H4 ALMAC Self Piercing Rivets
<b># 18127PK</b>  5.30 x 6.00mm Silver Steel H4 ALMAC Self Piercing Rivets	<b># 18128PK</b>  5.30 x 6.50mm Silver Steel H4 ALMAC Self Piercing Rivets	<b># 18129PK</b>  5.30 x 7.00mm Silver Steel H4 ALMAC Self Piercing Rivets	<b># 18130PK</b>  5.30 x 7.50mm Silver Steel H4 ALMAC Self Piercing Rivets	<b># 18131PK</b>  5.30 x 8.00mm Silver Steel H4 ALMAC Self Piercing Rivets	<b># 18132PK</b>  5.30 x 9.00mm Silver Steel H4 ALMAC Self Piercing Rivets



Contains 12 Different Sizes  
 1,100 Total Pieces  
 6 3/4" x 11" Plastic Tray  
 Silver Steel H4 ALMAC  
 Self Piercing Rivet Assortment

**Sold  
 Each**

## Tools & Supplies

### High Tungsten Steel Reamers



Gold surface treated body, these reamers are especially designed for the reaming of structural steel plates found in truck frames, rail cars, bridges and pressure vessels. For use only to enlarge previously formed or drilled holes.

Part #	Shank Diameter	Starting Hole	Flats On Shank	Overall Length	Finish	Qty.
18195	1/2"	3/8" Min.	3	5 7/8"	Gold	1 Pc.
18197	5/8"	7/16" Min.	3	6 3/8"	Gold	1 Pc.
18200	3/4"	1/2" Min.	3	6 7/8"	Gold	1 Pc.
18205	1"	7/8" Min.	3	6 7/8"	Gold	1 Pc.

**Disco** Automotive Hardware

Ph: 580-622-3090

Fax: 580-622-3781

discosales@discoautomotive.com

CNP5

06/19/19

# COOL NEW PRODUCTS

## # 8812



## Universal Door Panel Assortment

**BACK OF TRAY**

**# 8812**  
Universal Door Panel Assortment

1646PK 1/4" (6.50mm) Hole Size 21mm Stem Length 6.30mm x 11.50mm Head Dia. Natural Nylon Door Trim Panel Retainers 1	9339PK 9/32" (7mm) Hole Size 19mm Stem Length 7mm x 12.50mm Head Size White Nylon Door Trim Panel Retainers 2	2034PK 13/64" (5mm) Hole Size 15mm Stem Length 20mm Head Diameter Black Nylon Door Trim Panel Retainers 3	10403PK 9/32" (7mm) Hole Size 22mm Stem Length 19mm Head Diameter Black Nylon Door Trim Panel Retainers 4	9861PK 15/64" (6mm) Hole Size 24mm Stem Length 18mm Head Diameter White Nylon Door Trim Panel Retainers 5	2063PK 9/32" (7mm) Hole Size 15mm Stem Length 13mm Head Diameter White Nylon Door Trim Panel Retainers 6	2112PK 9/32" (7mm) Hole Size 19mm Stem Length 12.50mm Top Head Diameter Black Nylon Door Trim Panel Retainers 7	10649PK 9/32" (7mm) Hole Size 14.50mm Stem Length 15mm Head Diameter Yellow Nylon Door Trim Panel Retainers 8
1558PK 9/32" (7mm) Hole Size 19mm Stem Length 13.30mm Top Head Diameter Natural Nylon Door Trim Panel Retainers 9	9514PK 9/32" (7mm) Hole Size 19mm Stem Length 13mm Top Head Diameter Natural Nylon Door Trim Panel Retainers 10	1742PK 5/16" (8mm) Hole Size 1" Stem Length 1/2" Top Head Diameter Natural Nylon Door Trim Panel Retainers 11	1807PK 9/32" (7mm) Hole Size 24mm Stem Length 18mm Head Diameter White Nylon Door Trim Panel Retainers 12	10576PK 5/16" (8mm) Hole Size 14mm Stem Length 12.80mm Head Diameter Orange Nylon With Sealer Door Trim Panel Retainers 13	12886PK 5/16" (8mm) Hole Size 3/4" Stem Length 1/2" Top Head Diameter Yellow Nylon Door Trim Panel Retainers 14	9372PK 5/16" (8mm) Hole Size 21/32" Stem Length 13mm Head Diameter White Nylon Door Trim Panel Retainers 15	9444PK 5/16" (8mm) Hole Size 15mm Stem Length 13mm Head Diameter White Nylon Door Trim Panel Retainers 16
9539PK 5/16" (8mm) Hole Size 17.50mm Stem Length 13mm Head Diameter Natural Nylon Door Trim Panel Retainers 17	1575PK 5/16" (8mm) Hole Size 19mm Stem Length 12.70mm Top Head Diameter Black Nylon Door Trim Panel Retainers 18	10573PK 21/64" (6.50mm) Hole Size 13mm Stem Length 13mm Top Head Diameter Blue Nylon Door Trim Panel Retainers 19	10724PK 23/64" (8mm) Hole Size 17mm Stem Length 13mm Top Head Diameter White Nylon With Sealer Door Trim Panel Retainers 20	2108PK 3/8" (9.50mm) Hole Size 14mm Stem Length 15mm Top Head Diameter White Nylon Door Trim Panel Retainers 21	10701PK 3/8" (9.50mm) Hole Size 17mm Stem Length 19.50mm Top Head Diameter White Nylon With Sealer Door Trim Panel Retainers 22	4020PK 1/4" (6.50mm) Hole Size 6.30mm x 11.50mm Top Head Natural Nylon Door Trim Panel Retainers 23	9242PK 1/4" (6.50mm) Hole Size 21mm Stem Length 17mm Head Diameter Natural Nylon Door Trim Panel Retainers 24
592PK 9/32" (7mm) Hole Size 14.80mm Stem Length 17.6mm Head Diameter Natural Nylon Door Trim Panel Retainers 25	9373PK 9/32" (7mm) Hole Size 18mm Stem Length 13mm Head Diameter Black Nylon Door Trim Panel Retainers 26	1716PK 9/32" (7mm) Hole Size 25mm Stem Length 17mm Head Diameter Natural Nylon Door Trim Panel Retainers 27	9502PK 9/32" (7mm) Hole Size 27mm Stem Length 22mm Head Diameter White Nylon Door Trim Panel Retainers 28	12463PK 23/64" (8mm) Hole Size 15mm Stem Length 14mm Top Head Diameter White Nylon Door Trim Panel Retainers 29	5264PK 1/4" (6.50mm) Hole Size 29/32" Stem Length 29/32" Head Diameter Natural Nylon Door Trim Panel Retainers 30	1648PK 9/32" (7mm) Hole Size 24mm Stem Length 20mm Top Head Diameter White Nylon Door Trim Panel Retainers 31	9368PK 9/32" (7mm) Hole Size 32mm Stem Length 20mm Top Head Diameter Natural Nylon Door Trim Panel Retainers 32

**FRONT OF TRAY**

Contains 32 Different Sizes  
320 Total Pieces  
Adjustable Gray Tray  
Universal Door Trim  
Panel Assortment



Part #	Tray Type	Material	Tray #	Tray Color	Lid Color	Label Type	Clear Pocket	Qty.	
8812	Adjustable	Plastic	80132	Gray	Gray	Adhesive	No	1 Pc.	NEW
8812BCP	Adjustable	Plastic	80156BC	Dark Blue	Clear	Paper	Yes	1 Pc.	NEW
8812GCP	Adjustable	Plastic	80132GC	Gray	Clear	Paper	Yes	1 Pc.	NEW
8812RCP	Adjustable	Plastic	80153RC	Red	Clear	Paper	Yes	1 Pc.	NEW
8812YCP	Adjustable	Plastic	80132YC	Yellow	Clear	Paper	Yes	1 Pc.	NEW

**Disco** Automotive Hardware

Ph: 580-622-3090

Fax: 580-622-3781

discosales@discoautomotive.com

CNP6

10/21/19

# COOL NEW PRODUCTS

## Standard Fasteners

**Nuts Hex SAE Prevailing Torque Lock Grade "C" Zinc & Wax Finish**



Part #	Size	Hex Size	Grade	Material	Qty.
12870PK	1/4-28 (SAE)	7/16"	"C"	Zinc & Waxed	100 Pcs. <b>NEW</b>
12871PK	5/16-24 (SAE)	1/2"	"C"	Zinc & Waxed	100 Pcs. <b>NEW</b>
12872PK	3/8-24 (SAE)	9/16"	"C"	Zinc & Waxed	100 Pcs. <b>NEW</b>
12873PK	7/16-20 (SAE)	11/16"	"C"	Zinc & Waxed	50 Pcs. <b>NEW</b>
12874PK	1/2-20 (SAE)	3/4"	"C"	Zinc & Waxed	50 Pcs. <b>NEW</b>
12875PK	9/16-18 (SAE)	7/8"	"C"	Zinc & Waxed	25 Pcs. <b>NEW</b>
12876PK	5/8-18 (SAE)	15/16"	"C"	Zinc & Waxed	25 Pcs. <b>NEW</b>
12877PK	3/4-16 (SAE)	1-1/8"	"C"	Zinc & Waxed	25 Pcs. <b>NEW</b>
12878PK	7/8-14 (SAE)	1-5/16"	"C"	Zinc & Waxed	10 Pcs. <b>NEW</b>
12879PK	1-14 (SAE)	1-1/2"	"C"	Zinc & Waxed	10 Pcs. <b>NEW</b>

## Metric Fasteners

**Bolts Hex Flange Class 10.9 DIN 6921 Bright Zinc**



Part #	Size	Hex Size	Flange Size	Finish	Qty.
17948PK	10-1.50 x 20mm	15mm Indented	22.30mm	Bright Zinc	10 Pcs. <b>NEW</b>
17949PK	10-1.50 x 25mm	15mm Indented	22.30mm	Bright Zinc	10 Pcs. <b>NEW</b>
17950PK	10-1.50 x 30mm	15mm Indented	22.30mm	Bright Zinc	10 Pcs. <b>NEW</b>
17951PK	10-1.50 x 35mm	15mm Indented	22.30mm	Bright Zinc	10 Pcs. <b>NEW</b>
17952PK	10-1.50 x 40mm	15mm Indented	22.30mm	Bright Zinc	10 Pcs. <b>NEW</b>
17953PK	10-1.50 x 45mm	15mm Indented	22.30mm	Bright Zinc	10 Pcs. <b>NEW</b>
17954PK	10-1.50 x 50mm	15mm Indented	22.30mm	Bright Zinc	10 Pcs. <b>NEW</b>
17956PK	10-1.50 x 60mm	15mm Indented	22.30mm	Bright Zinc	10 Pcs. <b>NEW</b>
17958PK	10-1.50 x 70mm	15mm Indented	22.30mm	Bright Zinc	10 Pcs. <b>NEW</b>
17960PK	10-1.50 x 80mm	15mm Indented	22.30mm	Bright Zinc	10 Pcs. <b>NEW</b>
17962PK	10-1.50 x 90mm	15mm Indented	22.30mm	Bright Zinc	10 Pcs. <b>NEW</b>

**Nuts Hex Flange Class 10 DIN 6923 Bright Zinc**

17946PK 10-1.50mm Class 10  
15mm Hex Size  
21.80mm Serrated Flange  
Bright Zinc Finish  
Metric Spin Lock Nuts  
DIN 6923

25 Pcs.



**Disco** Automotive Hardware

Ph: 580-622-3090

Fax: 580-622-3781

discosales@discoautomotive.com

CNP7

06/26/19

# COOL NEW PRODUCTS

## Ford Clips & Fasteners

### Nuts Specialty

**18096PK** #8 (4.20mm) Screw Size  
11.70mm Width  
16.50mm Length  
Gray Finish With Sealer  
Specialty Nuts  
Ford # W713617-S439

15 Pcs.



**17908PK** #10 (4.80mm) Screw Size  
11mm Stem Length  
20mm Head Diameter  
11.50 x 7.50mm Hole Size  
Red Nylon Radiator Grille  
Screw Grommets  
Ford # W702438-S300

25 Pcs.



### Rivets Black All Aluminum

**13517PK** 3/16" (4.80mm) Rivet Diameter  
9.50mm Flange Size  
1.60mm-3.18mm Grip Range  
Black All Aluminum  
Countersunk Closed End Pop Rivets  
Ford # W717984-S417

15 Pcs.



### Retainers Shield

**18166PK** 13/32" (10.50mm) Hole Size  
45mm Stem Length  
25mm Head Diameter  
Black Nylon  
Rear Body & Trim Retainers  
Ford # W715951-S300

15 Pcs.



### Retainers Push Type

**17922PK** 1/4" (6.50mm) Hole Size  
11mm Stem Length  
25mm Flange Diameter  
Black Nylon  
Splash & Heat Shield  
Push Type Retainers  
Ford # W717823-S300

15 Pcs.



### Retainers Moulding

**13090PK** 23/64" (9mm) Hole Size  
14mm Stem Length  
12 x 20mm Top Head Size  
White Nylon With Sealer  
Rocker Panel Moulding Retainers  
Ford # W716352-S300

25 Pcs.



*Disco* Automotive Hardware

Ph: 580-622-3090

Fax: 580-622-3781

discosales@discoautomotive.com

CNP8

06/26/19



# COOL NEW PRODUCTS

## G.M. Clips & Fasteners

### Screws License Plate

**12556PK** 6.30-1.81 x 20mm  
14mm Head Diameter  
Duo-Drive Truss Head  
Silver Dacromet Finish  
License Plate Screws  
G.M. # 25732397

50 Pcs.



### Nuts Specialty

**9335PK** 10 x 1.50mm Screw Size  
20mm Outside Diameter Flange  
Black Finish  
Push On Type Retainers  
G.M. # 11502759

50 Pcs.



**18094PK** 6-1.00 Screw Size  
.70mm-3.80mm Panel Range  
9.25 x 13.75mm Hole Size  
Organic Zinc  
Rear Bumper Bracket Nuts  
G.M. # 11547582

25 Pcs.



### Retainers Push Type

**13089PK** 21/64" (8.50mm) Hole Size  
12mm Stem Length  
20mm Flange Diameter  
Black Nylon  
Front Fender & Body Side Liner  
Push Type Retainers  
G.M. # 11612035

25 Pcs.



### Retainers Moulding

**12600PK** 23/64" (9mm) Hole Size  
11mm Stem Length  
12 x 20mm Top Head Size  
White Nylon With Sealer  
Body Side & Trim Moulding Retainer  
GM # 11547581

25 Pcs.



**18095PK** 11mm Stem Length  
17 x 20mm Top Head Size  
Blue Nylon W/Metal Reinforced  
Windshield Pillar, Interior &  
Trunk Trim Moulding Retainers  
G.M. # 24405740

15 Pcs.



*Disco* Automotive Hardware

Ph: 580-622-3090

Fax: 580-622-3781

discosales@discoautomotive.com

CNP9

07/03/19

# COOL NEW PRODUCTS

## G.M. Clips & Fasteners

### Rivets Automotive

**9176PK** 1/4" (6.30mm) Diameter  
21/32" Flange Size  
5/32"-13/32" Grip Range  
White Nylon  
Blind Rivets  
G.M. # 15506827

25 Pcs.



### Retainers Weatherstrip

**10974PK** 13/64" (5mm) Hole Size  
9mm Stem Length  
5 x 15mm Head Diameter  
Natural Nylon  
Weatherstrip Retainers  
G.M. # 10283414, 10405030

100 Pcs.



### Retainers Push Type

**18167PK** 5/16" (8mm) Hole Size  
15mm Stem Length  
20mm Head Diameter  
Black Nylon  
Front Fender Retainers  
G.M. # 11546805

50 Pcs.

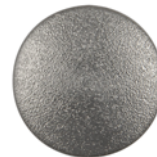

### Retainers Door Trim Panel

**18217PK** 7/16" (11mm) Hole Size  
7/16" Stem Length  
15/32 x 25/32" Top Head Size  
White Nylon With Sealer  
Door Trim Panel Retainers  
G.M. # 91176726

15 Pcs.



### Retainers Moulding

**18236PK** 23/64" (9mm) Hole Size  
20mm Stem Length  
9.50 x 20mm Top Head Size  
Yellow Nylon With Sealer  
Rocker Moulding Clips  
G.M. # 15864780, 11569921

10 Pcs.



**18119PK** 19mm Stem Length  
19mm Overall Height  
17.50 x 25mm Head Size  
Black Finish  
Grille Assembly Retainer  
G.M. # 11546500

10 Pcs.



*Disco* Automotive Hardware

Ph: 580-622-3090

Fax: 580-622-3781

discosales@discoautomotive.com

CNP10

07/03/19

# COOL NEW PRODUCTS

## Toyota Clips & Fasteners

### Nuts Specialty

**18164PK** #12 (5.50mm) Screw Size  
17mm Stem Length  
20mm Flange Diameter  
9mm Hole Size  
Black Nylon  
Fender Liner Screw Grommets  
Toyota # 90189-06236

25 Pcs.



### Retainers Phillips Screw

**17931PK** 17/64" (6.70mm) Hole Size  
24mm Stem Length  
Red Nylon W/Phillips Drive  
Body Side Retainers  
Toyota # 90467-09237

25 Pcs.



### Retainers Door Trim Panel

**17876PK** 5/16" (8mm) Hole Size  
13mm Stem Length  
13mm Top Head Diameter  
White Nylon  
Door Trim Panel Retainers  
Toyota # 67771-06010, 67771-32090

10 Pcs.



### Retainers Moulding

**17909PK** 9/32" (7mm) Hole Size  
10mm Stem Length  
20mm x 30mm Head Size  
Black Nylon With Sealer  
Front Fender Moulding Retainers  
Toyota # 53857-12010

15 Pcs.



**17611PK** 32mm Width  
39mm Length  
Black Nylon  
Front Bumper  
Cover Retainers  
Use With Disco # 11950  
Toyota # 53879-30040

5 Pcs.

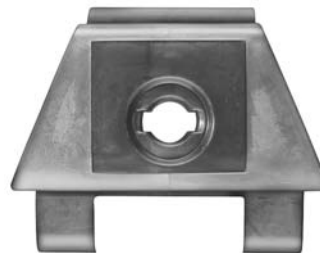

**11950PK** 10mm Head Diameter  
24mm Stem Length  
Black Nylon Front Bumper  
Cover & Fender Liner Pins  
Use With # 11951 & 17611  
Lexus # 47749-50090  
Toyota # 53879-30040

15 Pcs.



*Disco* Automotive Hardware

Ph: 580-622-3090

Fax: 580-622-3781

discosales@discoautomotive.com

CNP11

07/03/19

# COOL NEW PRODUCTS

## Toyota Clips & Fasteners

### Retainers Bumper

**18163PK** 3/8" (9.50mm) Hole Size  
14mm Top Rubber Diameter  
16.50mm Overall Length  
Rubber & Nylon  
Rear Door Bumper Retainers  
Toyota # 90541-09124

**25 Pcs.**



### Retainers Push Type

**18239PK** 9/32" (7mm) Hole Size  
12mm Stem Length  
20mm Head Diameter  
Black Nylon Bumper Cover,  
Radiator Support & Under Cover  
Push Type Retainers  
Toyota # 90467-09242

**25 Pcs.**



**18238PK** 9/32" (7mm) Hole Size  
15mm Stem Length  
22 Head Diameter  
Black Nylon Cowl Grille  
Push Type Retainers  
Toyota # 90767-09242

**15 Pcs.**



### Retainers Door Trim Panel

**18218PK** 3/8" (9.50mm) Hole Size  
15mm Stem Length  
13mm Top Head Diameter  
White Nylon With Sealer  
Door Trim Panel Retainers  
Toyota # 90467-09206

**15 Pcs.**



### Retainers Moulding

**9340PK** 21mm Overall Height  
7.50mm Width  
Pink Nylon Door Trim,  
Instrument Panel, Rear Deck &  
Roof Garnish Trim Moulding Retainers  
Toyota # 90467-12080

**25 Pcs.**



**18231PK** 17 x 22mm Hole Size  
10mm Stem Length  
28 x 37mm Head Size  
Black Nylon Rocker & Quarter  
Moulding Retainers  
Toyota # 76924-12030

**25 Pcs.**



*Disco* Automotive Hardware

Ph: 580-622-3090

Fax: 580-622-3781

discosales@discoautomotive.com



CNP12



07/10/19

# COOL NEW PRODUCTS



## Mazda Clips & Fasteners

### Retainers Push Type



<b>18234PK</b>	5/16" (8mm) Hole Size 13mm Stem Length 20mm Flange Diameter Black Nylon Bumper, Engine Cover, Fender & Quarter Panel Push Type Retainers Mazda # B45A-56-146A Toyota # 90118-WB048	<b>25 Pcs.</b>		
----------------	---------------------------------------------------------------------------------------------------------------------------------------------------------------------------------------------------------	----------------	------------------------------------------------------------------------------------	-------------------------------------------------------------------------------------



<b>18109PK</b>	5/16" (8mm) Hole Size 14mm Stem Length 20mm Head Diameter Black Nylon Bumper Cover & Fender Liner Push Type Retainers Mazda # BGV4-56-145	<b>25 Pcs.</b>		
----------------	-------------------------------------------------------------------------------------------------------------------------------------------------------------	----------------	------------------------------------------------------------------------------------	-------------------------------------------------------------------------------------



### Retainers Grille

<b>18107PK</b>	9mm Stem Width 13mm Stem Length 9 x 22mm Head Size Black Nylon Grille Emblem Retainers Mazda # G46L-50-EB1	<b>25 Pcs.</b>		
----------------	---------------------------------------------------------------------------------------------------------------------------	----------------	------------------------------------------------------------------------------------	-------------------------------------------------------------------------------------

### Retainers Moulding

<b>18112PK</b>	25/64" (10mm) Hole Size 14mm Stem Length 14mm Top Head Diameter Gray Nylon Wheel Arch Moulding Retainers Mazda # KD53-51-W24	<b>25 Pcs.</b>		
----------------	---------------------------------------------------------------------------------------------------------------------------------------------	----------------	--------------------------------------------------------------------------------------	---------------------------------------------------------------------------------------

<b>18114PK</b>	25/64" (10mm) Hole Size 14mm Stem Length 15mm Top Head Diameter White Nylon With Sealer Wheel Opening Moulding Retainers Mazda # KD51-51-W24	<b>15 Pcs.</b>		
----------------	-------------------------------------------------------------------------------------------------------------------------------------------------------------	----------------	--------------------------------------------------------------------------------------	---------------------------------------------------------------------------------------

<b>18104PK</b>	7/16" (11mm) Hole Size 9mm Stem Length 10 x 15mm Top Head Size Gray Nylon W/Sealer Stone Guard Moulding Retainers Mazda # KD53-51-SJ3A	<b>25 Pcs.</b>		
----------------	-------------------------------------------------------------------------------------------------------------------------------------------------------	----------------	--------------------------------------------------------------------------------------	---------------------------------------------------------------------------------------

*Disco* Automotive Hardware

Ph: 580-622-3090

Fax: 580-622-3781

discosales@discoautomotive.com

CNP13

07/10/19

# COOL NEW PRODUCTS

## Screws

### Screws Phillips Trim

**12904PK** 4.8-1.61 x 16mm  
11mm Head Diameter  
Black Finish  
Phillips Trim Screws

100 Pcs.



## Electrical Products

### Cable Ties

**12354PK** 5" Length .14" Width  
1.30" Max Bundle Diameter  
40lbs Tensile Strength  
Black Nylon  
Cable Ties

100 Pcs.



**9655PK** 11" Length .189" Width  
3.20" Max Bundle Diameter  
50 lbs. Tensile Strength  
Black Nylon  
#10 Screw Mounting Cable Ties

100 Pcs.



Not Actual Size



## G.M. Clips & Fasteners

### Nuts Specialty

**13423PK** 6-1.00 Thread Size  
11mm Overall Height  
Zinc Organic  
Radiator Grille & Front  
End Panel Nuts  
G.M. # 11518937

10 Pcs.



**17945PK** #10 (4.80mm) Screw Size  
11mm Stem Length  
9.50mm Head Diameter  
Natural Nylon  
Lower Door & Handle  
Interior Trim Grommets  
GM # 90230846, 94515248

25 Pcs.



### Retainers Moulding

**18165PK** 12mm Stem Length  
17 x 20mm Top Head Size  
Black Nylon W/Metal Reinforced  
Windshield Pillar & Interior  
Moulding Retainers  
G.M. # 24405739

15 Pcs.



*Disco* Automotive Hardware

Ph: 580-622-3090

Fax: 580-622-3781

discosales@discoautomotive.com

CNP14

12/11/19

# COOL NEW PRODUCTS

## Chrysler Clips & Fasteners

### Nuts Specialty

**12023PK** 5 -0.80mm Screw Size  
11mm Outside Diameter Flange  
Zinc Finish  
Push On Type Retainers  
Chrysler # 6100839

100 Pcs.



### Retainers Push Type

**18221PK** 1/4" (6.30mm) Hole Size  
7/8" Stem Length  
11/16" Diameter Flange  
Black Nylon Body  
Push Type Retainers  
Chrysler # 34202672  
Ford # N803362-S  
G.M. # 20510029

25 Pcs.



### Retainer Door Trim Panel

**17942PK** 7/16" (11mm) Hole Size  
19mm Stem Length  
16mm Top Head Diameter  
White Nylon  
Door Trim Panel Retainer  
Chrysler # 55116997AB, 55116997AA

25 Pcs.



### Retainers Grille

**11912PK** 1/2" Width  
23/32" Height  
Black Finish  
Grille To Fascia Retainers  
Chrysler # 4676356

15 Pcs.



### Retainers Moulding

**17943PK** 3/8" (9mm) Hole Size  
13mm Stem Length  
11 x 12mm Top Head Size  
White Nylon With Sealer  
Body Moulding Retainer  
Citroen & Peugeot # 856543  
Chrysler # 68093998-AA  
Fiat # 71728806

25 Pcs.



**18251PK** 23/64" (9mm) Hole Size  
15mm Stem Length  
14 x 20mm Top Head Size  
Black Nylon With Sealer  
Rocker Moulding Retainer  
Chrysler # 68283229AA

10 Pcs.



*Disco* Automotive Hardware

Ph: 580-622-3090

Fax: 580-622-3781

discosales@discoautomotive.com





CNP15

07/17/19



# COOL NEW PRODUCTS

## Honda Clips & Fasteners



### Nuts Specialty

<b>18229PK</b>	17mm Stem Length 22mm Overall Length 13mm Top Head Diameter Black Nylon Engine Cover Retainers Honda # 91547-TZ5-A02	<b>50 Pcs.</b>		
<b>18230PK</b>	13.50 x 7.60mm Hole Size 16mm Stem Length 22 x 14mm Head Size Dark Gray Engine Cover Grommets Honda # 91548-TZ5-A02	<b>25 Pcs.</b>		



### Retainers Wheel Well

<b>18110PK</b>	9/64" (3.50mm) Hole Size 16mm Stem Length 18mm Head Diameter Black Nylon Inner Fender Wheel Well Retainers Honda # 91512-SED-003	<b>25 Pcs.</b>		
----------------	-------------------------------------------------------------------------------------------------------------------------------------------------	----------------	------------------------------------------------------------------------------------	-------------------------------------------------------------------------------------

### Clips Hood Release Cable

<b>18106PK</b>	9/32" (7mm) Hole Size 6.50mm Stem Length Holds 5mm Diameter Cable Black Nylon Hood Release Cable Clip Honda # 91504-SDA-003	<b>25 Pcs.</b>		
----------------	--------------------------------------------------------------------------------------------------------------------------------------------	----------------	--------------------------------------------------------------------------------------	---------------------------------------------------------------------------------------

### Retainers Moulding

<b>17940PK</b>	13/32" (10mm) Hole Size 9mm Stem Length 10 x 12mm Head Size White Nylon With Sealer Lower Door Moulding Retainer Honda # 75316-TP6-A01	<b>25 Pcs.</b>		
----------------	-------------------------------------------------------------------------------------------------------------------------------------------------------	----------------	--------------------------------------------------------------------------------------	---------------------------------------------------------------------------------------

*Disco* Automotive Hardware

Ph: 580-622-3090

Fax: 580-622-3781

discosales@discoautomotive.com

CNP16

07/17/19



# COOL NEW PRODUCTS

## Hyundai Clips & Fasteners

### Nuts Specialty

**17932PK** 14mm Hex Size  
30mm Flange Diameter  
Black Nylon  
Wheel Well Liner &  
Splash Shield Nuts  
Hyundai # 84145-26000

15 Pcs.



**17939PK** #6 (3.5mm) Screw Size  
12mm Stem Length  
8 x 10mm Head Size  
White Nylon  
Bumper Grommet  
Hyundai # 86518-3M000

25 Pcs.



### Retainers Hood Prop

**18118PK** 8mm Rod Size  
14mm Hole Size  
24mm Length 20mm Width  
Black Nylon  
Hood Prop Rod Clips  
Hyundai # 81174-2L000

15 Pcs.



**18117PK** Holds 8mm Rod  
9mm Stem Length  
20 x 20mm Bottom Base Size  
Black Nylon  
Hood Prop Retainers  
Hyundai # 81174-21000,  
81174-11011, 81174-21010

15 Pcs.



### Retainers Weatherstrip

**18100PK** 13/64" (5mm) Hole Size  
6mm Stem Length  
5 x 13mm Head Size  
Red Nylon  
Weatherstrip Retainers  
Hyundai # 82133-37000

50 Pcs.



**17933PK** 13/64" (5mm) Hole Size  
11mm Stem Length  
5 x 15mm Top Head Size  
White Nylon  
Door Weatherstrip Retainers  
Hyundai # 82132-27100

25 Pcs.



**17937PK** 1/4" (6mm) Hole Size  
8mm Stem Length  
5 x 15mm Head Size  
Red Nylon  
Weatherstrip Retainers  
Hyundai # 87756-2W000

100 Pcs.



*Disco* Automotive Hardware

Ph: 580-622-3090

Fax: 580-622-3781

discosales@discoautomotive.com







CNP17

07/17/19

# COOL NEW PRODUCTS



## Hyundai Clips & Fasteners

### Retainers Moulding

17938PK	1/2" (12mm) Hole Size 10mm Stem Length 14 x 18mm Head Size Blue Nylon With Sealer Door Moulding Retainers Hyundai # 87756-D3000	25 Pcs.		
18116PK	25/64" (10mm) Hole Size 9mm Stem Length 13 x 16mm Head Size Pink Nylon With Sealer Side Garnish Moulding Retainers Hyundai # 87756-2J000	15 Pcs.		
17935PK	1/2" (12mm) Hole Size 17mm Stem Length 12 x 12mm Top Head Size Yellow Nylon With Sealer Moulding Retainers Hyundai # 87759-3V000	25 Pcs.		

## Nissan Clips & Fasteners

### Screw Grommets

18102PK	#12 (5.50mm) Screw Size 9mm Stem Length 10mm Top Head Size Yellow Nylon Front & Rear Bumper Screw Grommets Nissan # 85099-1MA0A	25 Pcs.		
---------	------------------------------------------------------------------------------------------------------------------------------------------------	---------	--------------------------------------------------------------------------------------	---------------------------------------------------------------------------------------

### Retainers Moulding

18101PK	5/16" (8mm) Hole Size 12mm Stem Length 10 x 17mm Top Head Size Green Nylon With Sealer Rocker Panel Moulding Retainers Nissan 76882-1KA1A	25 Pcs.		
18242PK	23/64" (9mm) Hole Size 12mm Stem Length 14 x 21.50mm Top Head Size Black Nylon Rocker Panel Moulding Retainers Nissan # N/A	25 Pcs.		

*Disco* Automotive Hardware

Ph: 580-622-3090

Fax: 580-622-3781

discosales@discoautomotive.com

CNP18

07/24/19

# COOL NEW PRODUCTS

## BMW Clips & Fasteners

### Screws Sems®

**13096PK** 4.8-1.61 x 16mm  
8mm Indented Hex Head  
18mm Outside Diameter Loose Washer  
Black Zinc  
Sems® Screws  
BMW # 17-14-7-129-160

50 Pcs.



### Nuts Specialty

**18099PK** 23/64" (9mm) Hole Size  
9mm Overall Height  
30mm Head Diameter  
Gray Nylon  
Sound Insulation Grommet  
BMW # 51-48-8-126-849

25 Pcs.



### Rivets Trim Cover

**18243PK** 15/64" (6mm) Diameter  
20mm Flange Size  
1.50mm - 10mm Grip Range  
White Nylon Wheel Arch  
Trim Cover Rivets  
BMW # 07147391324

25 Pcs.



**18244PK** 15/64" (6mm) Diameter  
20mm Flange Size  
2.50mm - 10.75 Grip Range  
Black Nylon Wheel Arch  
Trim Cover Rivets  
BMW # 07147293278

25 Pcs.



### Retainers Shield

**18115PK** 5/32" (4mm) Hole Size  
23mm Stem Length  
24mm Head Diameter  
Black Nylon T27 Drive  
Side Shield & Trim Retainers  
BMW # 07-14-7-296-886

25 Pcs.



**18103PK** 19/64" (7.50mm) Hole Size  
25mm Stem Length  
14mm Head Diameter  
Black Nylon Seat Back Panel  
Shield Retainer  
BMW # 52-20-1-964-201

25 Pcs.



*Disco* Automotive Hardware

Ph: 580-622-3090

Fax: 580-622-3781

discosales@discoautomotive.com

CNP19

07/24/19

# COOL NEW PRODUCTS

## Mazda Clips & Fasteners

### Clips Hood Release Cable

**18108PK** 15/64" (6mm) Hole Size  
9mm Stem Length  
Holds 5mm Diameter Cable  
Black Nylon  
Hood Release Cable Clips  
Mazda # D001-56-731

25 Pcs.



### Retainers Moulding

**18113PK** 25/64" (10mm) Hole Size  
12mm Stem Length  
13 x 17mm Top Head Size  
Green Nylon With Sealer  
Rocker Panel Moulding Retainers  
Mazda # D10E-51-SJ3

15 Pcs.



## Toyota Clips & Fasteners

### Retainers Moulding

**17944PK** 25/64" (10mm) Hole Size  
19mm Stem Length  
10.30 x 16.50mm Top Head Size  
Yellow Nylon With Sealer  
Rocker Moulding Retainers  
Toyota # 75494-42010, 75395-42020

25 Pcs.



## Volvo Clips & Fasteners

### Retainers Moulding

**18232PK** 5/16" (8mm) Hole Size  
18mm Stem Length  
13 x 22mm Top Head Size  
White Nylon  
Rocker Panel Moulding Retainers  
Volvo # 31214496

15 Pcs.



### Retainers Hood Insulation

**18233PK** 15mm Stem Length  
25 x 30mm Head Size  
Black Nylon  
Hood Insulation Retainers  
Volvo # 9182822

15 Pcs.



*Disco* Automotive Hardware

Ph: 580-622-3090

Fax: 580-622-3781

discosales@discoautomotive.com

CNP20

07/24/19

# COOL NEW PRODUCTS

## Oil Drain Hardware

### Gaskets Oil Drain Plug

**18228PK** 13mm Inside Diameter  
22mm Outside Diameter  
2.40mm Thickness  
Black Rubber  
Oil Drain Gaskets  
Ford # F5TZ-6734-BA

10 Pcs.



**18224PK** 18mm Inside Diameter  
24mm Outside Diameter  
2.50mm Thickness  
Steel Crushable  
Oil Drain Gaskets  
Toyota # 12157-10010

10 Pcs.



### Plugs Oil Drain

**18225PK** 24-1.50 x 11mm  
10mm Internal Hex Drive  
36mm Top Head Diameter  
Black Plastic With Rubber Seal  
Oil Drain Plugs  
BMW # 11-13-7-605-018

1 Pcs.



**18227PK** 13/16" Head Diameter  
1 13/16" Overall Length  
3/8" Square Drive  
Yellow Plastic W/ O-Ring Seal  
Oil Drain Plug  
Ford # BC3Z-6730-A

1 Pcs.



Not Actual Size

**18226PK** 23mm Head Diameter  
20mm Overall Length  
Slot For Screw Driver  
Black Plastic With O-Ring Seal  
Oil Drain Plugs  
Volkswagen # 06L-103-801

1 Pcs.



*Disco* Automotive Hardware

Ph: 580-622-3090

Fax: 580-622-3781

discosales@discoautomotive.com

CNP21

08/21/19

# COOL NEW PRODUCTS

## Assortments

Assortment Bolts & Nuts Class 10.9 Flange All Coarse Threads



3213PK



8-1.25 x 25mm

Class 10.9 Hex Flange Bolts

Part #	Class	Diameter	Length	Cabinet	Labels	Total Pcs.	Qty.	
8713A	Metric 10.9	6 to 10mm	12 to 90mm	# 80341 Gray Bin	Set #17822	915	1 Pc.	<b>NEW</b>
8713RA	Metric 10.9	6 to 10mm	12 to 90mm	# 80343 Red Bin	Set #17822	915		<b>DISCONTINUED</b>
8713BA	Metric 10.9	6 to 10mm	12 to 90mm	# 80365 Black Bin	Set #17822	915		<b>DISCONTINUED</b>

8-1.25 x 25mm

Class 10.9 Hex Flange Bolts

Part #	Class	Diameter	Length	Cabinet	Labels	Total Pcs.	Qty.	
8713B	Metric 10.9	6 to 10mm	12 to 90mm	# 80341 Gray Bin	Set #17831	915	1 Pc.	<b>NEW</b>
8713RB	Metric 10.9	6 to 10mm	12 to 90mm	# 80343 Red Bin	Set #17831	915		<b>DISCONTINUED</b>
8713BB	Metric 10.9	6 to 10mm	12 to 90mm	# 80365 Black Bin	Set #17831	915		<b>DISCONTINUED</b>

*Disco* Automotive Hardware

Ph: 580-622-3090

Fax: 580-622-3781

discosales@discoautomotive.com

CNP22

08/21/19

# COOL NEW PRODUCTS

## Specialty Nuts

### Nuts Washer Lock

**11865PK** 1/4"-20 Screw Size  
7/16" Hex Size  
19/32" Flange Diameter  
Zinc Finish  
Washer Lock Nuts

**100 Pcs.**



## Ford Clips & Fasteners

### Nuts Specialty

**18145PK** 3/8" (9.50mm) Hole Size  
21mm Stem Length  
Natural Rubber  
Rear Bumper Cover Grommets  
Use With # 17832

**25 Pcs.**



**18255PK** 3/8" (9.50mm) Hole Size  
21mm Stem Length  
Black Rubber  
Rear Bumper Cover Grommets  
Use With # 17832  
Ford # W708045-S300

**25 Pcs.**



### Retainers Shield

**17832PK** 9/32" (7mm) Hole Size  
25mm Stem Length  
21mm Head Diameter  
Black Nylon  
Rear Bumper Cover Retainers  
Use With # 18145  
Ford # W708035-S300

**25 Pcs.**



### Retainers Moulding

**15304PK** 23/64" (9mm) Hole Size  
16mm Stem Length  
14 x 18mm Top Head Size  
White Nylon With Sealer  
Rocker Moulding Clips  
Ford N/A

**10 Pcs.**



## BMW Clips & Fasteners

### Retainers Moulding

**13228PK** 5/16" (8mm) Hole Size  
8mm Stem Length  
13mm Top Head Diameter  
Black Nylon Rear Quarter  
Wheel Opening Moulding Clips  
BMW # 07-13-0-702-516

**25 Pcs.**



*Disco* Automotive Hardware

Ph: 580-622-3090

Fax: 580-622-3781

discosales@discoautomotive.com

CNP23

08/28/19

# COOL NEW PRODUCTS

## Service Equipment

### Storage Bins, 72 Hole



80364



80345



80366

Part #	Width	Depth	Height	Finish	Use With Stand	Qty.
80364	35 1/4"	11 7/8"	42"	Gray	#80353 or #80356	<b>DISCONTINUED</b>
80345	35 1/4"	11 7/8"	42"	Red	#80344	<b>DISCONTINUED</b>
80366	35 1/4"	11 7/8"	42"	Black	#80367	<b>DISCONTINUED</b>

## Assortments

### Assortment Honda Bumper Retainer

8216 Contains 6 Different Sizes  
89 Total Pieces  
Black Nylon  
Honda Cars  
Bumper Retainer Assortment

Sold  
Each



*Disco* Automotive Hardware

Ph: 580-622-3090

Fax: 580-622-3781

discosales@discoautomotive.com

CNP24

08/28/19



# COOL NEW PRODUCTS

## Kia Clips & Fasteners

### Retainers Moulding

**17914PK** 15/32" (12mm) Hole Size  
10mm Stem Length  
10 x 12mm Top Head Size  
Red Nylon With Sealer Fender,  
Rocker & Wheel Moulding Retainers  
Kia # 87756-C5000

25 Pcs.



## Mitsubishi Clips & Fasteners

### Retainers Moulding

**18111PK** 9/32" (7mm) Hole Size  
10mm Stem Length  
12mm Top Head Diameter  
White Nylon  
Moulding Retainers  
Mitsubishi # MU000573

25 Pcs.



### SPR Extraction Tool

**18219** Removes 3.35mm and 5.30mm Diameter  
Self Piercing Rivets  
Heavy Duty  
SPR Extraction Tool  
Use with a 3/4" Socket on a 1/2" Impact Gun

1 Pc.



### SPR Insertion Tool

**18220** Installs 3.35mm and 5.30mm Diameter  
Self Piercing Rivets  
Heavy Duty  
SPR Insertion Tool  
Use with a 3/4" Socket on a 1/2" Impact Gun

1 Pc.



*Disco* Automotive Hardware

Ph: 580-622-3090

Fax: 580-622-3781

discosales@discoautomotive.com

CNP25

08/28/19

# COOL NEW PRODUCTS

## # 8813



## Black Nylon Tie Strap Assortment

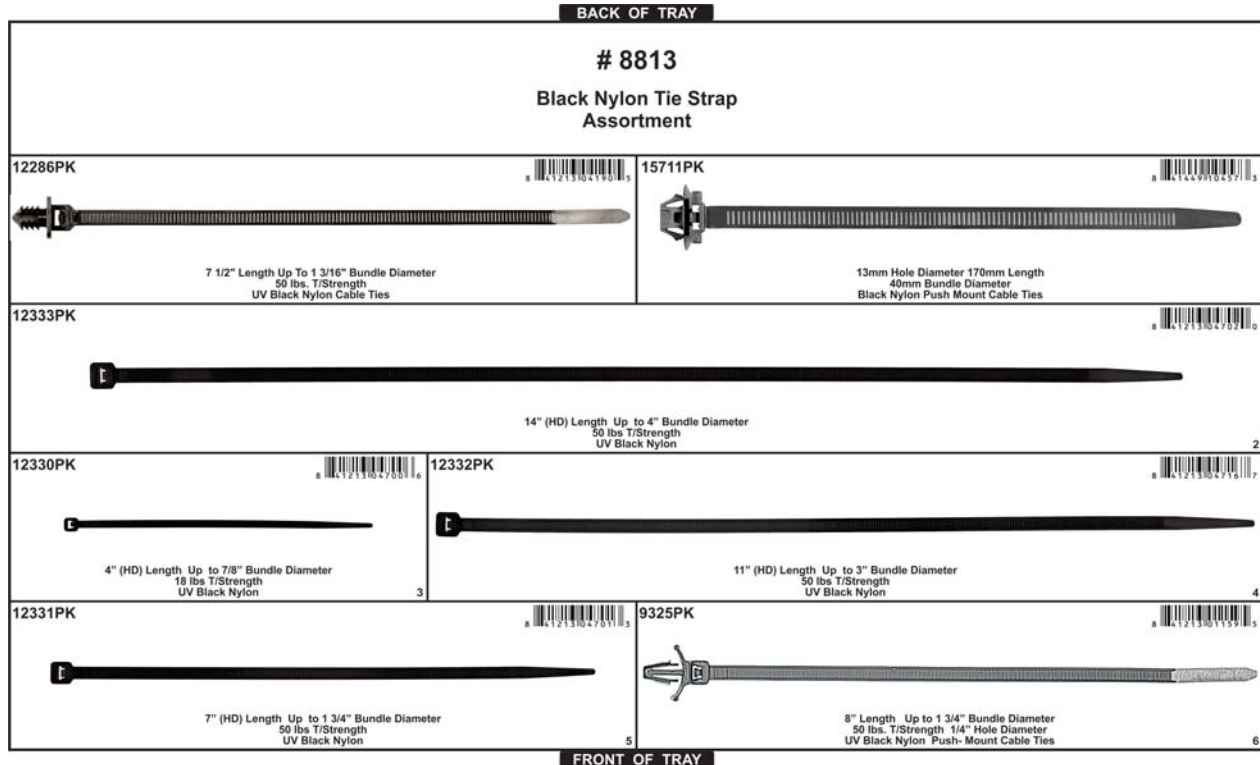

Contains 7 Different Sizes  
475 Total Pieces  
Sizes from 4" to 14"  
Black Nylon  
Tie Strap Assortment



Part #	Tray Type	Material	Tray #	Tray Color	Lid Color	Label Type	Clear Pocket	Qty.	
8813	Adjustable	Plastic	80132	Gray	Gray	Adhesive	No	1 Pc.	NEW
8813BCP	Adjustable	Plastic	80156BC	Dark Blue	Clear	Paper	Yes	1 Pc.	NEW
8813GCP	Adjustable	Plastic	80132GC	Gray	Clear	Paper	Yes	1 Pc.	NEW
8813RCP	Adjustable	Plastic	80153RC	Red	Clear	Paper	Yes	1 Pc.	NEW
8813YCP	Adjustable	Plastic	80132YC	Yellow	Clear	Paper	Yes	1 Pc.	NEW

**Disco** Automotive Hardware

Ph: 580-622-3090

Fax: 580-622-3781

discosales@discoautomotive.com

CNP26

09/04/19

# COOL NEW PRODUCTS

## Honda Clips & Fasteners

### Retainers Push Type

**18250PK** 5/16" (8mm) Hole Size  
11.50mm Stem Length  
10 x 10mm Top Head Size  
Black Nylon With Sealer  
Wheel Arch Protective  
Push Type Retainers  
Honda # 91513-T0A-A01

25 Pcs.



### Retainers Moulding

**18249PK** 20mm Width  
38mm Length  
Green Nylon  
Door Belt Moulding Clips  
Honda # 91503-SWA-A01

25 Pcs.



## Hyundai Clips & Fasteners

### Retainers Moulding

**17934PK** 7/16" (11mm) Hole Size  
14mm Stem Length  
17 x 25mm Head Size  
White Nylon With Sealer  
Rocker Moulding Retainers  
Hyundai # 87758-2S000

25 Pcs.



**17936PK** 1/2" (12mm) Hole Size  
9mm Stem Length  
10 x 13mm Head Size  
White Nylon With Sealer  
Rocker Moulding Retainers  
Hyundai # 87758-38000

50 Pcs.



## Mazda Clips & Fasteners

### Nuts Specialty

**18105PK** #10 (4.80mm) Screw Size  
Up to 1mm Panel Range  
11mm Center of Hole to Edge  
Gray Nylon Front Bumper  
"U" Type Nuts  
Mazda # C274-50-133

25 Pcs.



*Disco* Automotive Hardware

Ph: 580-622-3090

Fax: 580-622-3781

discosales@discoautomotive.com

CNP27

09/04/19

# COOL NEW PRODUCTS

## Electrical Products

### Connectors Self Stripping

**17923PK** 22-14 Gauge Wire  
Connects 2 or 3  
Unstripped Wires  
With Sealant  
Self Stripping Connectors  
For use to 600V maximum

10 Pcs.



## G.M. Clips & Fasteners

### Screws Pan Head Metric Torx®

**13421PK** 4.2-1.41 x 20mm  
9.50mm Pan Head  
17mm O.D. Loose Washer  
Black Zinc Metric Torx®  
With Dog Point Tap Screws  
G.M. # 11570637

50 Pcs.



### Screws Pozi-Drive Sems® Tapping

**17609PK** 4.2-1.41 x 25mm  
17mm Outside Diameter Loose Washer  
Black Zinc Pozi-Drive  
Round Washer Head  
Sems® Tapping Screws  
G.M. # 11609762

50 Pcs.



### Retainers Weatherstrip

**18247PK** 9/64" (3.50mm) Hole Size  
7/16" Stem Length  
13/32" Flange Diameter  
Black Nylon  
Weatherstrip Retainers  
G.M. # 4801268

100 Pcs.



## Ford Clips & Fasteners

### Screws Pan Head Sems®

**17930PK** 5-2.2 x 20mm  
20mm Outside Diameter Loose Washer  
Black Finish T30 Torx® Drive  
Pan Head Sems® Screws  
Use With 17833 & 17908  
Ford # W702413-S450B, W702413-S307

15 Pcs.



**Disco** Automotive Hardware

Ph: 580-622-3090

Fax: 580-622-3781

discosales@discoautomotive.com

CNP28

09/11/19

# COOL NEW PRODUCTS

## Windshield Retainers

### Blocks Windshield Setting

**13237PK** 51mm Overall Length  
Adhesive Backing  
Windshield Glass  
Setting Block  
G.M. # 15061964

10 Pcs.



## Toyota Clips & Fasteners

### Retainers Moulding

**18252PK** 7/8" (22mm) Hole Size  
11mm Stem Length  
38mm Head Diameter  
Black Nylon With Sealer  
Rocker Moulding Retainers  
Toyota # 90467-22014

10 Pcs.



**18253PK** 7/8" (22mm) Hole Size  
35mm Stem Length  
47mm Head Diameter  
Black Nylon With Sealer  
Rocker Moulding Retainers  
Toyota # 90467-22015

10 Pcs.



Not Actual Size

## Electrical Products

### Washers Terminal Protector

**15837PK** For Post & Side Terminals  
Fights Battery Corrosion  
Prolongs Battery Life  
Contains 1 Red & 1 Black  
Terminal Protector Washers

1 Set



Not Actual Size

*Disco* Automotive Hardware

Ph: 580-622-3090

Fax: 580-622-3781

discosales@discoautomotive.com

CNP29

10/02/19

# COOL NEW PRODUCTS

## Screws

### Screws Sheet Metal

**482PK** 6 x 1/4"  
Phillips Pan Head  
Bright Zinc Finish  
Sheet Metal Screws

100 Pcs.



### Screws Phillips Pozi Drive

**13114PK** 4.2-1.41 x 10mm  
Phillips Pozi Drive  
11mm Outside Diameter Washer Head  
Black Oxide  
Phillips Pozi Drive Screws  
G.M. # 11501903

100 Pcs.



## Oil Drain Hardware

### Plugs Steel Pipe

**17748PK** 1/2"-14  
Square Drive  
Zinc Finish  
Steel Pipe Plugs

10 Pcs.



## Electrical Products

### Bulb Halogen Headlight

**7H16** Clear  
12 Volt 19 Watt  
Base Type: PGJ19-3  
Bulb Shape: T-3 1/2  
Halogen Headlight Bulb

1 Pc.

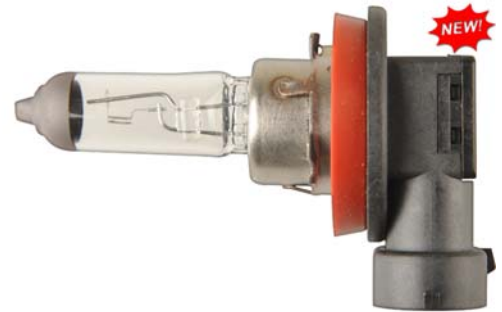

## Shield Retainers

### Retainers Weatherstrip

**18246PK** 13/32" (10.60mm) Hole Size  
10mm Stem Length  
12 x 15mm Top Head Size  
White Nylon Door  
Weatherstrip Retainers

15 Pcs.



*Disco* Automotive Hardware

Ph: 580-622-3090

Fax: 580-622-3781

discosales@discoautomotive.com

CNP30

10/02/19

# COOL NEW PRODUCTS

## Standard Fasteners

### Nuts Hex USS Nylon Lock Insert Bright Zinc Finish



	Size	Hex Size	Type	Finish	Qty.
12767PK	1/4"-20	7/16"	USS	Bright Zinc	100 Pcs.
12768PK	5/16"-18	1/2"	USS	Bright Zinc	100 Pcs.
12769PK	3/8"-16	9/16"	USS	Bright Zinc	50 Pcs.
12770PK	7/16"-14	5/8"	USS	Bright Zinc	25 Pcs.
12771PK	1/2"-13	3/4"	USS	Bright Zinc	25 Pcs.
12772PK	9/16"-12	7/8"	USS	Bright Zinc	25 Pcs. <b>NEW</b>
12773PK	5/8"-11	15/16"	USS	Bright Zinc	25 Pcs. <b>NEW</b>
12774PK	3/4"-10	1 1/8"	USS	Bright Zinc	25 Pcs. <b>NEW</b>

### Nuts Hex SAE Nylon Lock Insert Bright Zinc Finish



Part #	Size	Hex Size	Type	Finish	Qty.
12777PK	1/4"-28	7/16"	SAE	Bright Zinc	100 Pcs.
12778PK	5/16"-24	1/2"	SAE	Bright Zinc	100 Pcs.
12779PK	3/8"-24	9/16"	SAE	Bright Zinc	50 Pcs.
12780PK	7/16"-20	5/8"	SAE	Bright Zinc	25 Pcs.
12781PK	1/2"-20	3/4"	SAE	Bright Zinc	25 Pcs.
12782PK	9/16"-18	7/8"	SAE	Bright Zinc	25 Pcs. <b>NEW</b>
12783PK	5/8"-18	15/16"	SAE	Bright Zinc	25 Pcs.
12784PK	3/4"-16	1 1/8"	SAE	Bright Zinc	25 Pcs. <b>NEW</b>

## Ford Clips & Fasteners

### Screws Hex Head Sems®

12034PK 6.3-1.81 x 16mm  
16mm Outside Diameter Washer  
8mm Hex Head  
Black Finish  
Hex Head Sems® Screws  
Ford # N800312-S2

50 Pcs.



**Disco** Automotive Hardware

Ph: 580-622-3090

Fax: 580-622-3781

discosales@discoautomotive.com

CNP31

10/02/19

# COOL NEW PRODUCTS

## TRIM-KUT® DISCS NEW!

This is the exclusive manufacturer in the world for Trim-Kut. Trim-Kut is a revolutionary abrasive disc designed to grind and finish a wide variety of materials faster and cooler than any other abrasive disc available today. The patented process of fusing premium abrasive grains to a durable polymer backing results in a highly versatile grinding tool that requires no backing pad. Trim-Kut is readily trimmable to either renew the cutting surface or reduce the diameter. Trim-Kut discs are available in 3" and 5" for use on a drill or die grinder and 4.5" for use on an angle grinder. These durable discs can be used for grinding or sanding. Another major feature is that the discs can be trimmed. When the outside edge is loaded to the point where it is not grinding effectively, trim it off.

### TRIM KUT® DISC



**15826PK**

Mandrel tool comes included in each box of Trim Kut Discs & also sold in packages of 2.

Revolutionary trim down feature eliminates need for small disc for hard to get at areas.

Trim down feature reduces diameter of disc exposing a new grinding surface at operating R.P.M.

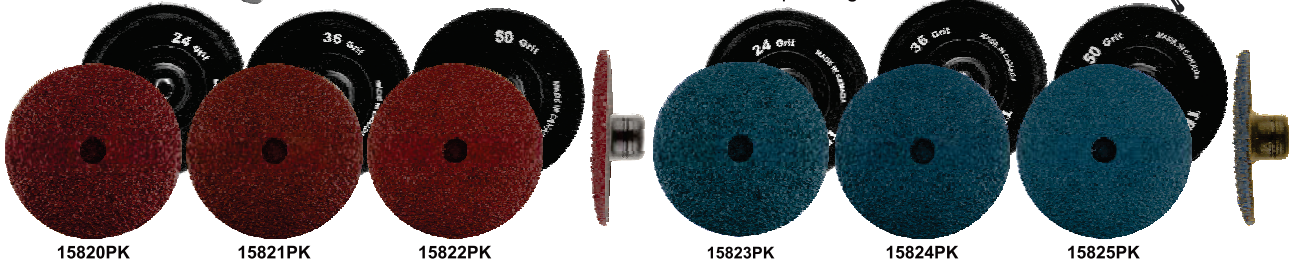

15820PK

15821PK

15822PK

15823PK

15824PK

15825PK

Part #	Grit	RPM	Color	Size	Contains	Qty.
15820PK	24	21,000 Max	Aluminum Oxide Maroon	3"	One 1/4" Mandrel	25 Discs
15821PK	36	21,000 Max	Aluminum Oxide Maroon	3"	One 1/4" Mandrel	25 Discs
15822PK	50	21,000 Max	Aluminum Oxide Maroon	3"	One 1/4" Mandrel	25 Discs
15823PK	24	21,000 Max	Zirconia Blue	3"	One 1/4" Mandrel	25 Discs
15824PK	36	21,000 Max	Zirconia Blue	3"	One 1/4" Mandrel	25 Discs
15825PK	50	21,000 Max	Zirconia Blue	3"	One 1/4" Mandrel	25 Discs

## ABRASIVE HAND PADS NEW!



Green

**15835PK**  
10 per pack  
Grit Industrial



Maroon

**15836PK**  
10 per pack  
Grit Medium



Gray

**15866PK**  
10 per pack  
Grit Ultra Fine

6" x 9"

Non-Woven Pads  
Impregnated with Resin

Used to prepare surfaces that contain rust or just general cleaning

**Disco** Automotive Hardware

Ph: 580-622-3090

Fax: 580-622-3781

discosales@discoautomotive.com

CNP32

10/30/19



# COOL NEW PRODUCTS

## Rivets

### Rivets Multi Grip Pop Aluminum & Steel

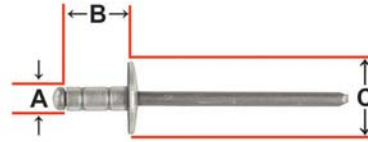
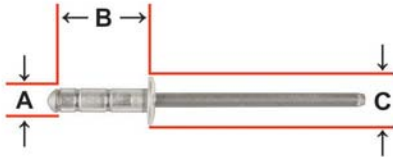

The Multi-Grip rivet will serve in applications where solid, soft materials and thicknesses normally require several rivet sizes. Oversize, irregular or misaligned holes are automatically compensated for by self adjusting hole-filling capability. The mandrel head is retained in the rivet body, forming a tight, weather resistant seal.

Part #	A-Rivet Diameter	Hole Size	Grip Range	B-Rivet Length	C-Flange Diameter	Flange Style	Material Type	Qty.	
17051PK	1/8"	.129 - .142"	5/32 - 5/16"	15/32"	1/4"	Dome	Alum/Steel	100 Pcs.	NEW
17052PK	1/8"	.129 - .142"	5/32 - 5/16"	15/32"	3/8"	Large Flange	Alum/Steel	100 Pcs.	NEW
17053PK	1/8"	.129 - .142"	1/4 - 7/16"	39/64"	1/4"	Dome	Alum/Steel	100 Pcs.	NEW
17054PK	5/32"	.160 - .173"	3/64 - 1/4"	13/32"	5/16"	Dome	Alum/Steel	100 Pcs.	NEW
17057PK	3/16"	.192 - .205"	1/16 - 1/4"	7/16"	3/8"	Dome	Alum/Steel	50 Pcs.	NEW
17058PK	3/16"	.192 - .205"	1/16 - 1/4"	7/16"	5/8"	Large Flange	Alum/Steel	50 Pcs.	NEW
17059PK	3/16"	.192 - .205"	3/16 - 3/8"	5/8"	3/8"	Dome	Alum/Steel	50 Pcs.	NEW
17060PK	3/16"	.192 - .205"	1/4 - 1/2"	47/64"	3/8"	Dome	Alum/Steel	50 Pcs.	NEW
17061PK	3/16"	.192 - .205"	1/4 - 1/2"	47/64"	5/8"	Large Flange	Alum/Steel	50 Pcs.	NEW
17062PK	3/16"	.192 - .205"	7/16 - 3/4"	1 1/16"	3/8"	Dome	Alum/Steel	50 Pcs.	NEW
17063PK	1/4"	.261 - .275"	5/64 - 11/32"	39/64"	1/2"	Dome	Alum/Steel	25 Pcs.	NEW

## Nissan Clips & Fasteners

### Screw Grommets

9688PK #8 (4.20mm) Screw Size  
 10mm Stem Length  
 16mm Head Diameter  
 9mm Hole Size  
 Natural Nylon  
 Bumper, Fender & Light  
 Screw Grommets  
 Nissan # 01281-00831

25 Pcs.



## G.M. Clips & Fasteners

### Grommets Tail Light

15816PK 25/64" (10mm) Hole Size  
 15mm Stem Length  
 18mm Head Diameter  
 White Nylon With Sealer  
 Tail Light Grommets  
 G.M. # 22884291

10 Pcs.



*Disco* Automotive Hardware

Ph: 580-622-3090

Fax: 580-622-3781

discosales@discoautomotive.com

CNP33

11/20/19

# COOL NEW PRODUCTS

## G.M. Clips & Fasteners

### Screws Tek®

**12816PK** 4.2-1.41 x 16mm  
7mm Indented Hex Head  
12mm Outside Diameter Loose Washer  
Black Finish  
Tek® Screws  
G.M. # 11503578, 11503785

50 Pcs.



### Screws Sheet Metal

**12669PK** 4.2-1.41 x 20mm  
7mm Indented Hex Head  
20mm Outside Diameter Loose Washer  
Black Finish  
Sheet Metal Screws  
Chrysler # 6506161-AA  
G.M. # 14090382

50 Pcs.



### Screws Hex Head Sems®

**12035PK** 6.3-1.81 x 30mm  
10mm Indented Hex Head  
17mm Outside Diameter Loose Washer  
Black Finish  
Hex Head Sems® Screws  
G.M. # 11500997

50 Pcs.



**10457PK** 6.3-1.81 x 30mm  
10mm Indented Hex Head  
24mm Outside Diameter Loose Washer  
Black Finish  
Hex Head Sems® Screws  
G.M. # 11504981

50 Pcs.



### Nuts Extruded "U"

**11043PK** #8 (4.20-1.41mm) Screw Size  
.65mm - 3.80mm Panel Range  
15mm Center of Hole To Edge  
Zinc Organic Prevailing Torque  
Extruded "U" Nuts  
G.M. # 11515638

25 Pcs.



### Nuts Bracket Retainer

**15864PK** #8 (4.20-1.41mm) Screw Size  
1.40 - 5mm Panel Range  
10.90 x 13mm Hole Size  
Green Metallic Finish  
Bracket Retainer Nuts  
G.M. # 11548673

15 Pcs.



*Disco* Automotive Hardware

Ph: 580-622-3090

Fax: 580-622-3781

discosales@discoautomotive.com

CNP34

11/20/19

# COOL NEW PRODUCTS

## Chrysler Clips & Fasteners

### Screws Phillips Flat Top Trim Bright Zinc

**11415PK** 10 x 1/2"  
Phillips Flat Top  
15/32" Outside Diameter Washer Head  
Bright Zinc Finish  
Trim Screws  
Chrysler # 9428273

100 Pcs.



**15682PK** 10 x 3/4"  
Phillips Flat Top  
15/32" Outside Diameter Washer Head  
Bright Zinc Finish  
Trim Screws  
Chrysler # 9427977

50 Pcs.



## Ford Clips & Fasteners

### Retainers Weatherstrip

**12067PK** 13/64" (5mm) Hole Size  
10mm Stem Length  
5 x 15mm Head Diameter  
Natural Nylon  
Weatherstrip Retainers  
Ford # N806340-S

100 Pcs.



### Retainers Fender Liner

**11250PK** 1/4" (6.30mm) Hole Size  
28mm Stem Length  
26mm Head Diameter  
Black Nylon  
Fender Liner Retainers  
Ford # W706635-SSW

50 Pcs.



### Retainers Door Trim Panel

**10448PK** 5/16" (7.90mm) Hole Size  
1 1/2" Stem Length  
1" Head Diameter  
Gray Nylon  
Trim Panel Retainers  
Ford # N806344-S

25 Pcs.



## Subaru Clips & Fasteners

### Retainers Push Type

**15337PK** 7/16" (11mm) Hole Size  
16mm Stem Length  
25mm Head Diameter  
Black Nylon With Sealer  
Rocker, Pillar, Floor & Trim  
Push Type Retainers  
Subaru # 90914-0002







25 Pcs.







# COOL NEW PRODUCTS

## Hyundai Clips & Fasteners

### Retainers Door Trim Panel



<b>15827PK</b>	16mm Overall Height 11mm Width Black Nylon Interior Trim Retainers Hyundai # 85858-3S000	<b>50 Pcs.</b>		
<b>15828PK</b>	19mm Overall Height 15mm Width Black Nylon Interior Trim Retainers Hyundai # 85859-3S100	<b>50 Pcs.</b>		
<b>15876PK</b>	21/64" (8.50mm) Hole Size 10mm Stem Length 13mm Top Head Diameter Green Nylon Interior Garnish Door Trim Panel Retainers Hyundai # 82315-2W000	<b>25 Pcs.</b>		

### Retainers Moulding

<b>15875PK</b>	5/16" (8mm) Hole Size 12mm Stem Length 17mm Flange Diameter Gray Nylon Rocker Panel Moulding Retainers Hyundai # 85815-24100	<b>25 Pcs.</b>		
<b>15874PK</b>	23/64" (9mm) Hole Size 15mm Stem Length 13mm Top Head Diameter Gray Nylon Garnish & Interior Moulding Retainers Hyundai # 85849-3L000	<b>50 Pcs.</b>		

## Kia Clips & Fasteners

### Retainers Moulding

<b>15873PK</b>	5/16" (8mm) Hole Size 12mm Stem Length 13mm Top Head Diameter Gray Nylon Exterior & Interior Moulding Retainers Kia # 0K95-A-68401	<b>50 Pcs.</b>		
----------------	---------------------------------------------------------------------------------------------------------------------------------------------------	----------------	--------------------------------------------------------------------------------------	---------------------------------------------------------------------------------------

*Disco* Automotive Hardware

Ph: 580-622-3090

Fax: 580-622-3781

discosales@discoautomotive.com

CNP36

12/11/19

# COOL NEW PRODUCTS

## Ford Clips & Fasteners

### Nuts Specialty

**15839PK** #12 (5.50mm) Screw Size  
15mm Stem Length  
16mm Head Diameter  
10mm Hole Size  
Natural Nylon Back Panel  
Attachment Grommets  
Ford # W700566-S300

25 Pcs.



### Plugs Oil Drain

**18257PK** 13/16" Diameter  
2 1/4" Overall Length  
Tab for Removal  
Yellow Plastic With Green "O" Ring  
Oil Drain Plug  
Ford KX6Z-6730-B

1 Pc.



Not Actual Size

### Retainers Shield

**9523PK** 9/32" (7mm) Hole Size  
1 3/32" Stem Length  
1 1/32" Head Diameter  
Black Nylon  
Headliner Retainers  
Ford # W710923-S300  
G.M. # 10229437, 10242316

25 Pcs.



### Retainers Push Type

**15852PK** 1/4" (6.40mm) Hole Size  
17/32" Stem Length  
5/8" Head Diameter  
Black Nylon  
Push Type Retainers  
Ford # N805231S

50 Pcs.



**15838PK** 9/32" (7mm) Hole Size  
10mm Stem Length  
13mm Flange Diameter  
Black Nylon Front Fender  
Push Type Retainers  
Ford # W707365-S300

10 Pcs.



### Retainers Phillips Screw

**9600PK** 25/64" (10mm) Hole Size  
11mm Stem Length  
20 x 30mm Head Size  
Nylon  
Phillips Screw Retainers  
Ford E7ZG-17A904-B  
Mazda BF67-50-033

10 Pcs.



*Disco* Automotive Hardware

Ph: 580-622-3090

Fax: 580-622-3781

discosales@discoautomotive.com

CNP37

01/08/20

# COOL NEW PRODUCTS

## G.M. Clips & Fasteners

### Nuts Specialty

**15829PK** #10 (4.8mm) Screw Size  
8mm Stem Length  
13mm Head Diameter  
8mm Hole Size  
White Nylon  
License Plate Grommets  
G.M. # 3783006

50 Pcs.



### Bolts Body Metric

**12057PK** 8-1.25 x 35mm  
13mm Indented Hex Head  
24mm Outside Diameter Loose Washer  
Black Finish  
Metric Body Bolts  
G.M. # 11503668

25 Pcs.



## Chrysler Clips & Fasteners

### Screws Hex Head Sems®

**18097PK** 4.8-1.61 x 32mm  
8mm Indented Hex Head  
19mm Outside Diameter Loose Washer  
Black Phosphate  
Sems® Screws  
Chrysler # 6509539-AA

50 Pcs.



## Audi Clips & Fasteners

### Nuts Specialty

**15862PK** 5mm Stud Size  
10mm Hex Size  
18.50mm Flange Diameter  
10.50mm Overall Height  
Black Nylon  
Moulding Flange Nuts  
Audi # 171-201-969

25 Pcs.

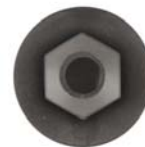

## Honda Clips & Fasteners

### Retainers Push Type

**13236PK** 9/32" (7mm) Hole Size  
14mm Stem Length  
16mm Head Diameter  
Black Nylon Interior Trim  
Push Type Retainers  
Honda # 91550-S50-000ZL

15 Pcs.



**Disco** Automotive Hardware

Ph: 580-622-3090

Fax: 580-622-3781

discosales@discoautomotive.com

CNP38

01/08/20

# COOL NEW PRODUCTS

## Toyota Clips & Fasteners

### Retainers Hood Seal

**11978PK** 13/64" (5mm) Hole Size  
8mm Stem Length  
5 x 13mm Head Size  
Black Nylon  
Hood Seal Retainers  
Toyota # 65487-60010

25 Pcs.



### Retainers Fender Seal

**11979PK** 5/16" (8mm) Hole Size  
16mm Stem Length  
16mm Head Diameter  
Black Nylon  
Fender Seal Retainers  
Toyota # 90467-07208

25 Pcs.



### Retainers Door Trim Panel

**11976PK** 23/64" (9mm) Hole Size  
15mm Stem Length  
10mm Top Head Size  
Yellow Nylon With Sealer  
Door Garnish Retainers  
Toyota # 76817-68010

25 Pcs.



**11977PK** 23/64" (9mm) Hole Size  
10mm Stem Length  
13mm Top Head Diameter  
Blue Nylon With Sealer  
Door Trim Retainers  
Toyota # 67771-26240

25 Pcs.



### Retainers Moulding

**11974PK** 9/32" (7mm) Hole Size  
11mm Stem Length  
8mm Top Head Size  
Yellow Nylon With Sealer  
Rocker Moulding Retainers  
Toyota # 62955-50010

25 Pcs.



**11975PK** 5/16" (8mm) Hole Size  
10mm Stem Length  
14.50 x 16mm Head Size  
Black Nylon  
Fender Liner Retainers  
Toyota # 90467-06192

25 Pcs.



**11973PK** 9/16" (14mm) Hole Size  
11mm Stem Length  
25mm Head Diameter  
Black Nylon  
Rocker Moulding Retainers  
Toyota # 76924-13020

25 Pcs.



*Disco* Automotive Hardware

Ph: 580-622-3090

Fax: 580-622-3781

discosales@discoautomotive.com

CNP39

01/22/20

# COOL NEW PRODUCTS

## Screws

### Screws Phillips Flat Washer Head Tekes

**12647PK** 8 x 1/2"  
#2 Tekes®  
13/32" Outside Diameter Washer  
Bright Zinc Finish  
Phillips Flat Washer Head Screws



### Screws Phillips Truss Head Trim

**13362PK** 4.2-1.41 x 16mm  
Phillips Truss Head  
9.50mm Head Diameter  
Black Finish  
Trim Screws



## G.M. Clips & Fasteners

### Screws Torx Truss Head

**10123PK** 5.50 x 20mm  
Torx® Truss Head  
15mm Outside Diameter Washer  
Black Zinc Finish Screws  
Use With # 15729  
G.M. # 13144822



## Ford Clips & Fasteners

### Screws Phillips Oval Washer Head Tekes®

**12595PK** 8 x 3/4"  
Phillips Oval Washer Head  
7/16" O.D. Washer  
Bright Zinc Tekes®  
Door Scuff Plate  
Ford # 382413-S9, 382413-S2



### Retainers Shield

**9510PK** 1/4" (6.30mm) Hole Size  
1 1/8" Stem Length  
1" Head Diameter  
Black Nylon Cowl Side Trim  
Shield Retainers  
Ford # E9SB-6302354-ACW



## Chrysler Clips & Fasteners

### Nuts Specialty

**15868PK** 8.50 x 11.00mm Hole Size  
36mm Stem Length  
18mm Head Diameter  
Black Nylon Rocker Panel &  
Splash Sheild Screw Grommet  
With Specialty Screw  
Chrysler # 6510123AA



**Disco** Automotive Hardware

Ph: 580-622-3090

Fax: 580-622-3781

discosales@discoautomotive.com

CNP40

01/22/20



# COOL NEW PRODUCTS

## Service Equipment

### Cabinet Large 4 Drawer

80371

23 1/2" Width 22" Depth 15" Height  
Gray Finish  
Large 4 Drawer Cabinet  
Does Not Include, Trays or Dividers

1 Pc.



Not Actual Size

## Service Equipment

### Drawer Dividers, Gray Finish

80370

Cabinet Drawer Dividers  
5 1/8" Width x 2 7/8" Height  
Gray Plastic  
Use With # 80369

1 Pc.



Not Actual Size

### Jumbo Tray Gray Plastic

80369

20 5/8" x 21 1/4" x 3"  
Adjustable  
Gray Plastic Jumbo Tray  
Used With Cabinets # 80360 & 80371

1 Pc.

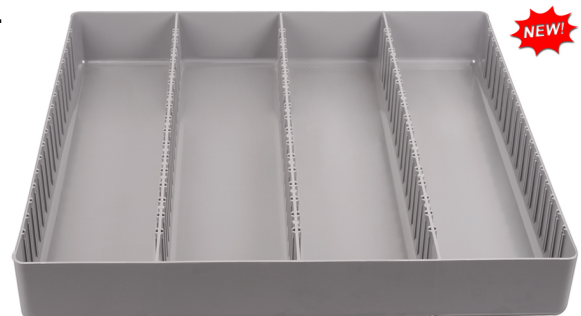

Not Actual Size

*Disco* Automotive Hardware

Ph: 580-622-3090

Fax: 580-622-3781

[discosales@discoautomotive.com](mailto:discosales@discoautomotive.com)

CNP41

05/20/20

# COOL NEW PRODUCTS

## Base Gray Finish

**80361** 23 1/2" Width 22" Depth 6" Height  
Gray Finish  
Large Cabinet Base  
Use With # 80360 & # 80371

1 Pc.



Not Actual Size

## G.M. Clips & Fasteners

### Nuts Specialty

**15691PK** 4.2-1.41 #8 Screw Size  
Zinc Organic  
Center Console Door,  
Front Lights, Grille,  
Lift Gate Nuts With Silicone Pad  
G.M. # 11610157

10 Pcs.



### Nuts Well Black Rubber

**15953PK** 10-24 Screw Size  
3/8" Hole Size 37/64" Length  
.030-.227" Grip Range  
Black Rubber  
Well Nuts  
G.M. # 3876130

25 Pcs.



### Retainers Moulding

**14995PK** 10mm Stem Length  
17 x 24mm Top Head Size  
Blue Nylon With Sealer  
Interior Trim & Windshield Pillar  
Moulding Retainers  
G.M. # 11611367

10 Pcs.



## Ford Clips & Fasteners

### Nuts Specialty

**15983PK** #8 (4.80mm) Screw Size  
7mm Stem Length  
14mm x 23mm Head Size  
Zinc Organic  
Front & Rear Bumper  
Specialty Nuts With Pastisol Pad  
Ford # W715197-S439

10 Pcs.



*Disco* Automotive Hardware

Ph: 580-622-3090

Fax: 580-622-3781

discosales@discoautomotive.com

CNP42

05/20/20

# COOL NEW PRODUCTS

## BMW Clips & Fasteners

### Nuts Specialty

11954PK

#8 (4.20mm) Screw Size  
3mm-4mm Panel Range  
7mm Center of Hole to Edge  
Zinc Finish  
Speed Type "U" Nuts  
BMW # 0712-9-925-708  
Mercedes # 000-994-25-45

50 Pcs.



## Honda Clips & Fasteners

### Retainers Push Type

13221PK

25/64" (10mm) Hole Size  
12mm Stem Length  
30mm Head Diameter  
Black Nylon  
Engine Cover Push Retainers  
Honda # 91505-TY2-003

15 Pcs.

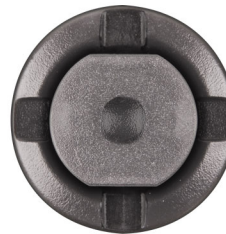

## Mazda Clips & Fasteners

### Retainers Push Type

15853PK

15/64" (6mm) Hole Size  
16mm Stem Length  
14mm Head Diameter  
Black Nylon  
Interior Trim  
Push Type Retainers  
Mazda # B101-68-252-00

25 Pcs.



## Toyota Clips & Fasteners

### Nuts Specialty

15812PK

#12 (5.50mm) Screw Size  
17mm Stem Length  
20mm Head Diameter  
9mm Square Hole Size  
Black Nylon  
Screw Grommets  
Toyota # 90189-A0002

25 Pcs.

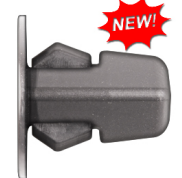

### Retainers Cowl Panel

15947PK

9/32" (7mm) Hole Size  
14mm Stem Length  
8mm x 17mm Head Size  
Black Nylon  
Cowl Panel Retainers  
Toyota # 90467-10146

25 Pcs.



**Disco** Automotive Hardware

Ph: 580-622-3090

Fax: 580-622-3781

discosales@discoautomotive.com



CNP43

05/20/20

# COOL NEW PRODUCTS

## Rivets



### Rivets Self Piercing (SPR)

<b>18133PK</b>	5.30 x 10.00mm Silver Steel H4 ALMAC Self Piercing Rivets (SPR) Check OEM or OE Vendor Specs. Before Using This Part	<b>100 Pcs.</b>		 <b>NEW!</b>
----------------	----------------------------------------------------------------------------------------------------------------------------------	-----------------	-------------------------------------------------------------------------------------	-------------------------------------------------------------------------------------------------



<b>18134PK</b>	5.30 x 12.00mm Silver Steel H4 ALMAC Self Piercing Rivets (SPR) Check OEM or OE Vendor Specs. Before Using This Part	<b>100 Pcs.</b>		 <b>NEW!</b>
----------------	----------------------------------------------------------------------------------------------------------------------------------	-----------------	-------------------------------------------------------------------------------------	-------------------------------------------------------------------------------------------------

## G.M. Clips & Fasteners

### Retainers Fascia



<b>9311PK</b>	1/4" (6.30mm) Hole Size 1 1/16" Stem Length 1/2" Head Diameter Black Nylon Rear Bumper Fascia Retainers G.M. # 22536642	<b>50 Pcs.</b>		 <b>NEW!</b>
---------------	----------------------------------------------------------------------------------------------------------------------------------------	----------------	------------------------------------------------------------------------------------	-------------------------------------------------------------------------------------------------

### Retainers Moulding

<b>15870PK</b>	23/64" (9mm) Hole Size 16mm Stem Length 12 x 20mm Top Head Size Blue Nylon With Sealer Rocker Moulding Retainers G.M. # 11547211	<b>10 Pcs.</b>		 <b>NEW!</b>
----------------	-------------------------------------------------------------------------------------------------------------------------------------------------	----------------	-------------------------------------------------------------------------------------	--------------------------------------------------------------------------------------------------

## Kia Clips & Fasteners

### Retainers Moulding

<b>15978PK</b>	7/16" (11mm) Hole Size 12mm Stem Length 10 x 12mm Top Head Size Gray Nylon With Sealer Liftgate Moulding Clips Kia # 87382-2W000	<b>25 Pcs.</b>		 <b>NEW!</b>
----------------	-------------------------------------------------------------------------------------------------------------------------------------------------	----------------	--------------------------------------------------------------------------------------	---------------------------------------------------------------------------------------------------

*Disco* Automotive Hardware

Ph: 580-622-3090

Fax: 580-622-3781

discosales@discoautomotive.com

CNP44

06/24/20

# COOL NEW PRODUCTS

## Standard Fasteners

**Screws Grade 8 Hex Head Yellow Zinc**



Not Actual Size

Part #	Size	Hex Head	Qty.
11569PK	5/8-11 x 7" USS	15/16"	1Pc.
11591PK	3/4-10 x 7" USS	1 1/8"	1 Pc.
11594PK	3/4-10 x 8 1/2" USS	1 1/8"	1 Pc.
11624PK	1-8 x 8 1/2" USS	1 1/2"	1 Pc.

## Shield Retainers

### Retainers Shield

**15980PK** 13/64" (5.20mm) Hole Size  
11/16" Stem Length  
3/4" Head Diameter  
.065-.515" Panel Range  
Black Nylon  
Shield Retainers

50 Pcs.



## Chrysler Clips & Fasteners

### Retainers Grille

**15688PK** 19/64" (7.50mm) Hole Size  
14mm Stem Length  
10 x 42mm Head Size  
Black Nylon Front Bumper  
Fascia To Grille Retainers  
Chrysler # 4857699-AA

25 Pcs.



## Subaru Clips & Fasteners

### Retainers Push Type

**15321PK** 9/32" (7mm) Hole Size  
10mm Stem Length  
15mm Head Diameter  
Black Nylon  
Cowl & Bumper  
Push Type Retainers  
Subaru # 90914-0062

15 Pcs.



**Disco** Automotive Hardware

Ph: 580-622-3090

Fax: 580-622-3781

discosales@discoautomotive.com

CNP45

06/24/20

# COOL NEW PRODUCTS

## Ford Clips & Fasteners

### Nuts Specialty

**11909PK** 10-1.50mm Screw Size  
15mm Hex Size  
24mm O.D. Loose Washer  
Black Finish  
Metric Hex Nuts  
Chrysler # 6100053  
Ford # N621942-S301, N621942-S441,  
N621942-S2

25 Pcs.



## Mazda Clips & Fasteners

### Retainers Push Type

**15951PK** 9/32" (7mm) Hole Size  
11mm Stem Length  
11mm Head Diameter  
Black Nylon  
Push Type Retainers  
Mazda # S51S-51-833

15 Pcs.



## Assortments

### Assortments Windshield Pillar Moulding

# 8102 Windshield Pillar Moulding Clip Assortment					
<b># 18095PK</b>  11mm Stem Length 17 x 20mm Top Hd. Size Blue Nylon W/Metal Reinforced Windshield Pillar, Interior & Trunk Trim Moulding Retainers	<b># 13519PK</b>  10mm Stem Length 17 x 24mm Top Head Red Nylon Metal Reinforced Door Sill Plate Retainers	<b># 13104PK</b>  10mm Stem Length 17 x 24mm Top Hd. Size Blue Nylon W/Metal Reinforced Interior Trim & Windshield Pillar Moulding Retainers	<b># 17588PK</b>  10mm Stem Length 17 x 24mm Top Hd. Size Red Nylon W/Metal Reinforced Case Fuses Interior Trim & Windshield Garnish Moulding Retainers	<b># 18165PK</b>  12mm Stem Length 17mm x 20mm Top Hd. Sz. Black Nylon W/Metal Reinforced Windshield Pillar & Interior Moulding Retainers	<b># 14995PK</b>  10mm Stem Length 17 x 24mm Top Head Size Blue Nylon W/ Sealer W/Metal Reinforced Interior Trim & Windshield Pillar Moulding Retainers



**8102** Contains 6 Different Sizes  
90 Total Pieces  
Interior & Trunk Trim  
Windshield Pillar  
Moulding Clip Assortment

**Sold Each**

*Disco* Automotive Hardware

Ph: 580-622-3090

Fax: 580-622-3781

discosales@discoautomotive.com























CNP46

08/19/20

# COOL NEW PRODUCTS

## Assortments

### Assortment Multi Grip Rivet

# 8218 Multi Grip Rivet Assortment					
# 17051PK  1/8" Diameter 5/32" - 5/16" Grip Range 1/4" Flange Size Aluminum Steel Multi Grip Pop Rivets 	# 17052PK  1/8" Diameter 5/32" - 5/16" Grip Range 3/8" Flange Size Aluminum Steel Multi Grip Pop Rivets 	# 17053PK  1/8" Diameter 1/4" - 7/16" Grip Range 1/4" Flange Size Aluminum Steel Multi Grip Pop Rivets 	# 17054PK  5/32" Diameter 3/64" - 1/4" Grip Range 13/32" Flange Size Aluminum Steel Multi Grip Pop Rivets 	# 17057PK  3/16" Diameter 1/16" - 1/4" Grip Range 3/8" Flange Size Aluminum Steel Multi Grip Pop Rivets 	# 17058PK  3/16" Diameter 1/16" - 1/4" Grip Range 5/8" Flange Size Aluminum Steel Multi Grip Pop Rivets 
# 17059PK  3/16" Diameter 3/16" - 3/8" Grip Range 3/8" Flange Size Aluminum Steel Multi Grip Pop Rivets 	# 17060PK  3/16" Diameter 1/4" - 1/2" Grip Range 3/8" Flange Size Aluminum Steel Multi Grip Pop Rivets 	# 17061PK  3/16" Diameter 1/4" - 1/2" Grip Range 5/8" Flange Size Aluminum Steel Multi Grip Pop Rivets 	# 17062PK  3/16" Diameter 7/16" - 3/4" Grip Range 3/8" Flange Size Aluminum Steel Multi Grip Pop Rivets 	# 17063PK  1/4" Diameter 5/64" - 1/32" Grip Range 1/2" Flange Size Aluminum Steel Multi Grip Pop Rivets 	



**8218** Contains 11 Different Sizes  
 150 Total Pieces  
 1/8 to 1/4" Hole Size  
 Aluminum Rivet Steel Mandrel  
 Pop Multi Grip Rivets

**1 Pc.**

## Standard Fasteners

### Nuts Serrated Flange Zinc



Part #	Screw Size	Hex Size	Flange	Type	Finish	Qty.
15784PK	1/4"-20	7/16"	19/32"	USS	Zinc	100 Pcs.
15785PK	5/16"-18	1/2"	11/16"	USS	Zinc	100 Pcs. <b>NEW</b>
256PK	3/8"-16	9/16"	3/4"	USS	Zinc	100 Pcs.
9078PK	7/16"-14	11/16"	15/16"	USS	Zinc	50 Pcs.

## Electrical Products

### Bulb Miniature Light

**75202** Clear 12 Volt 24 Watt  
 Bulb Shape G-6  
 Bass Type PG20-3  
 Usage: Fog Lights  
 Miniature Light Bulbs  
 Industrial # 5202

**1 Pc.**



*Disco* Automotive Hardware

Ph: 580-622-3090

Fax: 580-622-3781

discosales@discoautomotive.com

CNP47

09/02/20

# COOL NEW PRODUCTS

## Standard Fasteners

*Nuts Hex Grade 8 Nylon Insert Lock Bright Yellow Zinc Finish*

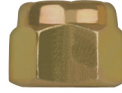

Part #	Size	Hex Size	Type	Finish	Qty.
12378PK	1/4"-20	7/16"	USS	Yellow Zinc	100 Pcs. <b>NEW</b>
12379PK	5/16"-18	1/2"	USS	Yellow Zinc	100 Pcs. <b>NEW</b>
12380PK	3/8"-16	9/16"	USS	Yellow Zinc	100 Pcs.
12381PK	7/16"-14	11/16"	USS	Yellow Zinc	50 Pcs. <b>NEW</b>
12382PK	1/2"-13	3/4"	USS	Yellow Zinc	50 Pcs.
12383PK	9/16"-12	7/8"	USS	Yellow Zinc	25 Pcs.
12384PK	5/8"-11	15/16"	USS	Yellow Zinc	25 Pcs.
12385PK	3/4"-10	1 1/8"	USS	Yellow Zinc	25 Pcs.
12386PK	7/8"-9	1 5/16"	USS	Yellow Zinc	10 Pcs.
12387PK	1"-8	1 1/2"	USS	Yellow Zinc	10 Pcs. <b>NEW</b>

## Honda Clips & Fasteners

### Retainers Moulding

15976PK

16.50mm Overall Height  
9mm Width  
White Nylon  
Grille Moulding Clips  
Honda # 90666-SDA-A01

25 Pcs.



## Toyota Clips & Fasteners

### Retainers Push Type

15952PK

9/32" (7mm) Hole Size  
10mm Stem Length  
20mm Head Diameter  
Black Nylon Fender Liner  
Push Type Retainers  
Toyota # 90467-07215

25 Pcs.



15954PK

42mm Width  
29.50mm Length  
Black Nylon  
Fender Liner Retainers  
Use With # 11950  
Toyota # 53879-30050

15 Pcs.



*Disco* Automotive Hardware

Ph: 580-622-3090

Fax: 580-622-3781

discosales@discoautomotive.com

CNP48

10/24/20



# COOL NEW PRODUCTS

## BMW Clips & Fasteners

### Retainers Torx Screw

**15979PK**

11/16" (7mm) Hole Size  
T10 Torx® Drive  
7mm Stem Length  
20mm Head Diameter  
Black Nylon  
Rocker Trim Wheelhouse Retainers  
Use With # 13372 & 13377  
BMW # 07-14-7-122-913

15 Pcs.



### Retainers Door Trim Panel

**13377PK**

1/2" (12.70mm) Hole Size  
27mm Stem Length  
30mm Head Diameter  
Black Nylon Rocker Moulding &  
Door Sill Trim Retainers  
Use With # 15979  
BMW # 51717066226

15 Pcs.



**13372PK**

1/2" (12.70mm) Hole Size  
32mm Stem Length  
30mm Head Diameter  
Black Nylon  
Rocker Panel & Wheelhouse  
Trim Retainers  
Use With # 15979  
BMW # 07147122912

15 Pcs.



### Retainers Moulding

**15977PK**

5/16" (8mm) Hole Size  
11mm Stem Length  
11 x 19mm Top Head Size  
Gray Nylon  
Moulding Retainers  
BMW # 07-13-2-757-821, 003-80-14348

15 Pcs.



## Honda Clips & Fasteners

### Retainers Push Type

**15981PK**

5/16" (8mm) Hole Size  
21mm Stem Length  
16mm Head Diameter  
Black Nylon Rear Panel  
Push Type Retainers  
Honda # 91561-S84-A00-M1,  
91561-S84-A21ZB

10 Pcs.



*Disco* Automotive Hardware

Ph: 580-622-3090

Fax: 580-622-3781

discosales@discoautomotive.com

CNP49

12/23/20

# COOL NEW PRODUCTS

## Service Equipment

### Storage Bins, 72 Hole



80375

This Cabinet will not fit  
Old discontinued numbers below:  
Gray Base 80356  
Gray Stand 80353  
Gray Storage Bin 80341

Part #	Width	Depth	Height	Finish	Use With	Qty.	
80375	33 3/4"	12"	42"	Gray	# 80372 & 80378	1 Pc.	<b>NEW</b>

### Storage Bins, 40 Hole

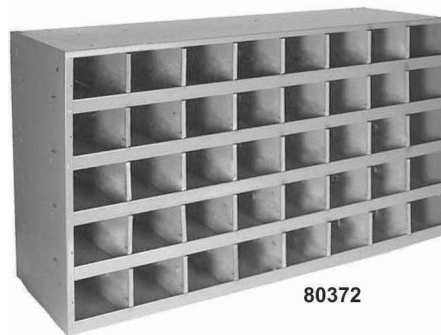

80372

These Cabinets will not fit  
Old discontinued numbers below:  
Gray Base 80356  
Gray Stand 80353  
Gray Storage Bin 80364

Part #	Width	Depth	Height	Finish	Use With	Qty.	
80372	33 3/4"	12"	23 7/8"	Gray	# 80375 & 80378	1 Pc.	<b>NEW</b>

### Storage Bins, Stand



80378

These Stands will not fit  
Old discontinued numbers below:  
Gray Storage Bin 80364  
Gray Storage Bin 80341

Part #	Width	Depth	Height	Finish	Use With	Qty.	
80378	33 3/4"	12 1/4"	5 3/4"	Gray	# 80372 & 80375	1 Pc.	<b>NEW</b>

*Disco* Automotive Hardware

Ph: 580-622-3090

Fax: 580-622-3781

discosales@discoautomotive.com

CNP50

12/23/20

# COOL NEW PRODUCTS

## Service Equipment

### Trays Large Metal Gray Finish

80382

18" Width x 12" Depth x 3" Height  
24 Hole with Catch  
Large Gray Metal Tray

1 Pc.



Not Actual Size

### Racks 4 Rods Wire Spool Gray Finish

80381

26 1/8" Width x 5 7/8" Depth 36 1/2" Height  
Gray Finish  
Wire Spool Rack

1 Pc.



Not Actual Size

*Disco* Automotive Hardware

Ph: 580-622-3090

Fax: 580-622-3781

[discosales@discoautomotive.com](mailto:discosales@discoautomotive.com)

CNP51

12/23/20

# COOL NEW PRODUCTS

## Service Equipment

### Stands Large 4 Drawer Cabinet Gray Finish



NEW!

This stand made to fit slider #80328 only.

**80329** 20 3/4" Width 14 1/4" Depth 15" Height  
Gray Finish  
Metal Slider Stand  
Use With # 80328

1 Pc.

### Cabinets With Ball Bearing Sliders Gray Finish

#### High Quality Ball Bearing Sliders



NEW!

This slider made to fit stand #80329 only.

**80328** 20 1/2" Width 14" Depth 15" Height  
Gray Finish Holds 4 Trays  
With Ball Bearings  
Large Metal Slider  
Use With # 80329

1 Pc.

*Disco* Automotive Hardware

Ph: 580-622-3090

Fax: 580-622-3781

discosales@discoautomotive.com

CNP52

01/13/21

# COOL NEW PRODUCTS

## G.M. Clips & Fasteners

### Nuts Specialty

**18261PK**

4.80mm Stud Size  
17mm Head Diameter  
9.80mm Hole Size  
Black Rubber  
Tail Lamp Grommet  
G.M. # 11571225

**10 Pcs.**



### Retainers Headliner

**16062PK**

9mm Stem Length  
12 x 22mm Top Head Size  
Black Nylon  
Headliner Retainers  
G.M. # 11547523, 11601777

**15 Pcs.**



### Retainers Door Trim Panel

**15985PK**

15/64" (6mm) Hole Size  
9mm Stem Length  
10mm Top Head Diameter  
White Nylon  
Door Panel Retainers  
G.M. # 11602522, 11603260

**25 Pcs.**



## Ford Clips & Fasteners

### Retainers Door Trim Panel

**16061PK**

6mm (15/64") Hole Size  
9mm Stem Length  
12.50mm Head Diameter  
Black Nylon Bumper &  
Mud Guard Retainers  
Ford # W718046-S300

**25 Pcs.**

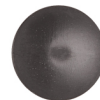

**16060PK**

8mm (5/16") Hole Size  
17mm Stem Length  
20mm Head Diameter  
Black Nylon Fender, Bumper &  
Interior Trim Retainers  
Ford # W715926-S300

**25 Pcs.**



*Disco* Automotive Hardware

Ph: 580-622-3090

Fax: 580-622-3781

discosales@discoautomotive.com

CNP53

01/13/20

# COOL NEW PRODUCTS

## Metric Fasteners

### Screws Metric Class 10.9 Hex Head Cap Yellow Zinc Finish



DIN # 933  
Full Threaded



DIN # 931  
Partially Threaded

Part #	Size	Hex Size	Din	Qty.
14424PK	6-1.00 x 10mm	10mm	933	50 Pcs.
14425PK	6-1.00 x 12mm	10mm	933	50 Pcs. <b>NEW</b>
14426PK	6-1.00 x 16mm	10mm	933	25 Pcs. <b>NEW</b>
14427PK	6-1.00 x 20mm	10mm	933	25 Pcs.
14428PK	6-1.00 x 25mm	10mm	933	25 Pcs.
14429PK	6-1.00 x 30mm	10mm	933	25 Pcs.
14431PK	6-1.00 x 40mm	10mm	933	25 Pcs.
14433PK	6-1.00 x 50mm	10mm	931	25 Pcs.
14435PK	6-1.00 x 60mm	10mm	931	25 Pcs.
14437PK	6-1.00 x 70mm	10mm	931	25 Pcs.
14439PK	6-1.00 x 80mm	10mm	931	25 Pcs.

## Shield Retainers

### Weatherstrip Retainers

**12066PK** 13/64" (5mm) Hole Size  
10mm Stem Length  
5 x 15mm Head Diameter  
White Nylon  
Weatherstrip Retainers **50 Pcs.**



## Tools & Supplies

### Bits Carbide Spot Weld Drill

**16066PK** 8mm Drill Size  
For 5/16" Spot Welds  
3-Edged High Speed  
Drills Through Boron Steel  
Black Finish  
Carbide Spot Weld Drill Bits **1 Pc.**



## Nissan Clips & Fasteners

### Retainers Door Trim Panel

**15896PK** 8mm Hole Size  
14mm Stem Length  
13mm Top Head Diameter  
White Nylon  
Quarter Panel Trim Retainers  
Nissan # 01553-0162U **25 Pcs.**



**Disco** Automotive Hardware

# COOL NEW PRODUCTS

## # 8814



## Self Piercing & Blind Rivets Assortment

BACK OF TRAY					
# 8814 Self Piercing & Blind Rivets Assortment					
18121PK 3.35 x 3.5mm Silver Steel H4 ALMAC Self Piercing Rivets (SPR) Check OEM or OE Vendor Specs. Before Using This Part 1	18122PK 3.35 x 4.0mm Silver Steel H4 ALMAC Self Piercing Rivets (SPR) Check OEM or OE Vendor Specs. Before Using This Part 2	18123PK 3.35 x 5.0mm Silver Steel H4 ALMAC Self Piercing Rivets (SPR) Check OEM or OE Vendor Specs. Before Using This Part 3	18124PK 3.35 x 6.0mm Silver Steel H4 ALMAC Self Piercing Rivets (SPR) Check OEM or OE Vendor Specs. Before Using This Part 4	18125PK 5.3 x 4.0mm Silver Steel H4 ALMAC Self Piercing Rivets (SPR) Check OEM or OE Vendor Specs. Before Using This Part 5	9054PK 17/64" (6.80mm) Diameter 1/2" Flange Size 3/32" - 3/16" Grip Range Black Nylon Blind Rivets 6
18126PK 5.3 x 5.0mm Silver Steel H4 ALMAC Self Piercing Rivets (SPR) Check OEM or OE Vendor Specs. Before Using This Part 7	18127PK 5.3 x 6.0mm Silver Steel H4 ALMAC Self Piercing Rivets (SPR) Check OEM or OE Vendor Specs. Before Using This Part 8	18128PK 5.3 x 6.5mm Silver Steel H4 ALMAC Self Piercing Rivets (SPR) Check OEM or OE Vendor Specs. Before Using This Part 9	18129PK 5.3 x 7.0mm Silver Steel H4 ALMAC Self Piercing Rivets (SPR) Check OEM or OE Vendor Specs. Before Using This Part 10	18130PK 5.3 x 7.5mm Silver Steel H4 ALMAC Self Piercing Rivets (SPR) Check OEM or OE Vendor Specs. Before Using This Part 11	1390PK 1/4" (6.40mm) Diameter 1/2" Flange Size 5/32" - 13/32" Grip Range Black Nylon Blind Rivets 12
18131PK 5.3 x 8.0mm Silver Steel H4 ALMAC Self Piercing Rivets (SPR) Check OEM or OE Vendor Specs. Before Using This Part 13	18132PK 5.3 x 9.0mm Silver Steel H4 ALMAC Self Piercing Rivets (SPR) Check OEM or OE Vendor Specs. Before Using This Part 14	18133PK 5.3 x 10.0mm Silver Steel H4 ALMAC Self Piercing Rivets (SPR) Check OEM or OE Vendor Specs. Before Using This Part 15	18134PK 5.3 x 12.00mm Silver Steel H4 ALMAC Self Piercing Rivets (SPR) Check OEM or OE Vendor Specs. Before Using This Part 16	1195PK 13/64" (5.20mm) Diameter 15/32" Flange Size 15/64" - 25/64" Grip Range Black Nylon Blind Rivets 17	5770PK 1/4" (6.40mm) Diameter 21/32" Flange Size 5/32" - 13/32" Grip Range Black Nylon Blind Rivets 18
13328PK 1/4" (6.30mm) Diameter 1/2" Flange Size .060" - .138" Grip Range F-150 Trucks With Alum. Body All Steel Pop Rivets 19	12623PK 1/4" (6.30mm) Diameter 1/2" Flange Size .110" - .189" Grip Range F-150 Trucks With Alum. Body All Steel Pop Rivets 20	12625PK 1/4" (6.30mm) Diameter 1/2" Flange Size .189" - .238" Grip Range F-150 Trucks With Alum. Body All Steel Pop Rivets 21	13329PK 1/4" (6.30mm) Diameter 1/2" Flange Size .268 - .346" Grip Range F-150 Trucks With Alum. Body All Steel Pop Rivets 22	5769PK 13/64" (5.20mm) Diameter 15/32" Flange Size 1/8" - 15/64" Grip Range Black Nylon Blind Rivets 23	5775PK 17/64" (6.80mm) Diameter 23/32" Flange Size 3/32" - 3/16" Grip Range Black Nylon Blind Rivets 24
FRONT OF TRAY					

Contains 24 Different Sizes  
1,055 Total Pieces  
3.5 - 6.80mm Hole Size  
Self Piercing, Nylon &  
Pop Rivet Assortment



Part #	Tray Type	Material	Tray #	Tray Color	Lid Color	Label Type	Clear Pocket	Qty.	
8814	24 Hole	Plastic	80123	Gray	Gray	Adhesive	No	1 Pc.	NEW
8814BCP	24 Hole	Plastic	80155BC	Dark Blue	Clear	Paper	Yes	1 Pc.	NEW
8814GCP	24 Hole	Plastic	80123GC	Gray	Clear	Paper	Yes	1 Pc.	NEW
8814RCP	24 Hole	Plastic	80152RC	Red	Clear	Paper	Yes	1 Pc.	NEW
8814YCP	24 Hole	Plastic	80123YC	Yellow	Clear	Paper	Yes	1 Pc.	NEW

**Disco** Automotive Hardware

Ph: 580-622-3090

Fax: 580-622-3781

discosales@discoautomotive.com

CNP55

02/10/21

# COOL NEW PRODUCTS

## # 8815



## Hex Washer Head Tek<sup>®</sup> Screw Assortment

BACK OF TRAY					
# 8815 Hex Washer Head Tek <sup>®</sup> Screw Assortment					
12215PK 8 x 1/2" 1/4" Indented Hex Head #2 Tek Point Black Finish Tek <sup>®</sup> Screws	12216PK 8 x 3/4" 1/4" Indented Hex Head #2 Tek Point Black Finish Tek <sup>®</sup> Screws	12217PK 8 x 1" 1/4" Indented Hex Head #2 Tek Point Black Finish Tek <sup>®</sup> Screws	12222PK 10 x 1/2" 5/16" Indented Hex Head #2 Tek Point Black Finish Tek <sup>®</sup> Screws	12223PK 10 x 3/4" 5/16" Indented Hex Head #3 Tek Point Black Finish Tek <sup>®</sup> Screws	1970PK 14 x 3/4" 3/8" Indented Hex Head #3 Tek Point Bright Zinc Finish Tek <sup>®</sup> Screws
12224PK 10 x 1" 5/16" Indented Hex Head #3 Tek Point Black Finish Tek <sup>®</sup> Screws	1077PK 8 x 1/2" 1/4" Indented Hex Head #2 Tek Point Bright Zinc Finish Tek <sup>®</sup> Screws	1078PK 8 x 3/4" 1/4" Indented Hex Head #2 Tek Point Bright Zinc Finish Tek <sup>®</sup> Screws	9791PK 8 x 1" 1/4" Indented Hex Head #2 Tek Point Bright Zinc Finish Tek <sup>®</sup> Screws	9792PK 8 x 1 1/4" 1/4" Indented Hex Head #2 Tek Point Bright Zinc Finish Tek <sup>®</sup> Screws	1971PK 14 x 1" 1/2" Flange Size #3 Tek Point Bright Zinc Finish Tek <sup>®</sup> Screws
9353PK 8 x 1 1/2" 1/4" Indented Hex Head #2 Tek Point Bright Zinc Finish Tek <sup>®</sup> Screws	9841PK 10 x 1/2" 5/16" Indented Hex Head #2 Tek Point Bright Zinc Finish Tek <sup>®</sup> Screws	1079PK 10 x 5/8" 5/16" Indented Hex Head #3 Tek Point Bright Zinc Finish Tek <sup>®</sup> Screws	9346PK 10 x 3/4" 5/16" Indented Hex Head #3 Tek Point Bright Zinc Finish Tek <sup>®</sup> Screws	1080PK 10 x 1" 5/16" Indented Hex Head #3 Tek Point Bright Zinc Finish Tek <sup>®</sup> Screws	9797PK 14 x 1 1/4" 3/8" Indented Hex Head #3 Tek Point Bright Zinc Finish Tek <sup>®</sup> Screws
9793PK 10 x 1 1/4" 5/16" Indented Hex Head #3 Tek Point Bright Zinc Finish Tek <sup>®</sup> Screws	9794PK 10 x 1 1/2" 5/16" Indented Hex Head #3 Tek Point Bright Zinc Finish Tek <sup>®</sup> Screws	9843PK 12 x 3/4" 5/16" Indented Hex Head #3 Tek Point Bright Zinc Finish Tek <sup>®</sup> Screws	9795PK 12 x 1" 5/16" Indented Hex Head #3 Tek Point Bright Zinc Finish Tek <sup>®</sup> Screws	9796PK 12 x 1 1/4" 5/16" Indented Hex Head #3 Tek Point Bright Zinc Finish Tek <sup>®</sup> Screws	9842PK 14 x 1 1/2" 3/8" Indented Hex Head #3 Tek Point Bright Zinc Finish Tek <sup>®</sup> Screws
FRONT OF TRAY					

Contains 24 Different Sizes  
835 Total Pieces  
Black & Bright Zinc Finish  
Hex Washer Head  
Tek<sup>®</sup> Screws Assortment

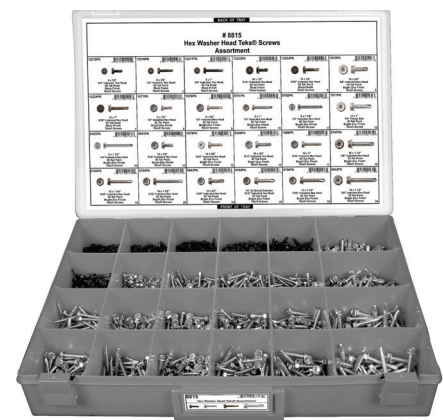

Part #	Tray Type	Material	Tray #	Tray Color	Lid Color	Label Type	Clear Pocket	Qty.	
8815	24 Hole	Plastic	80123	Gray	Gray	Adhesive	No	1 Pc.	NEW
8815BCP	24 Hole	Plastic	80155BC	Dark Blue	Clear	Paper	Yes	1 Pc.	NEW
8815GCP	24 Hole	Plastic	80123GC	Gray	Clear	Paper	Yes	1 Pc.	NEW
8815RCP	24 Hole	Plastic	80152RC	Red	Clear	Paper	Yes	1 Pc.	NEW
8815YCP	24 Hole	Plastic	80123YC	Yellow	Clear	Paper	Yes	1 Pc.	NEW

**Disco** Automotive Hardware

Ph: 580-622-3090

Fax: 580-622-3781

discosales@discoautomotive.com

CNP56

02/10/21



# COOL NEW PRODUCTS

## Assortments

Kits Disco Starter

# Disco Starter Kit # 8056



**NEW!**

**This Setup Covers  
All The Items On  
The Disco  
1EP Wall Poster**



**\*Shelves Not Included**



**Contains:**

- 5 Bags of the top 50 most popular
- 4 Bags of the next 50 most popular
- 2 Bags of the last 112 items
- 212 of the 4" Storage Boxes
- 5 Catalogs & 10 of the 1EP Wall Posters

- No guessing on what to order & how to stock
- Great system for PBE or Warehouse Suppliers
- Top 212 most popular body shop items
- Ready to sell in 674 packaged bags with photo & description.
- Supplied with bin boxes, labels with photos, quantity & description.
- Includes: Wall Charts, Catalogs & Planographs on how to set up & lots more
- The #8056 Disco Starter System comes with everything you need to get you selling A.S.A.P.

**8056**

Top Selling 212 Items  
674 Total Bags  
Includes: Catalogs, Posters,  
Labels & Storage Bin Boxes

**1 Pc.**

**Disco** Automotive Hardware

Ph: 580-622-3090

Fax: 580-622-3781

discosales@discoautomotive.com

CNP57

04/28/21

# COOL NEW PRODUCTS

## Tools & Supplies

### Wheels Rubber Eraser

**16057**

Smooth Style  
3 1/2" Outside Diameter  
15mm Width  
5/16 - 24 Spindle/ Adapter  
Rubber Eraser Wheel  
4000 Max RPM  
For the removal vinyl decals, pinstripping,  
adhesive tapes from metal, glass,  
fiberglass and wood without damaging  
sub-surface.

1 Pc.



Not Actual Size

**16058**

Sun Flower Style  
3 1/2" Outside Diameter  
20mm Width  
5/16 - 24 Spindle/ Adapter  
Rubber Eraser Wheel  
4000 Max RPM  
For the removal vinyl decals, pinstripping,  
adhesive tapes from metal, glass,  
fiberglass and wood without damaging  
sub-surface.

1 Pc.

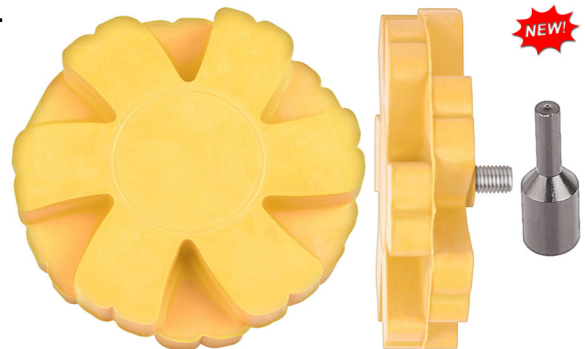

Not Actual Size

**16059**

Tractor Tire Style  
4" Outside Diameter  
26mm Width  
5/16 - 24 Spindle/ Adapter  
Rubber Eraser Wheel  
4000 Max RPM  
For the removal vinyl decals, pinstripping,  
adhesive tapes from metal, glass,  
fiberglass and wood without damaging  
sub-surface.

1 Pc.

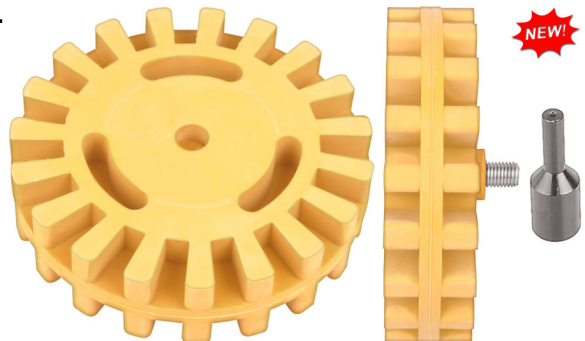

Not Actual Size

*Disco* Automotive Hardware

Ph: 580-622-3090

Fax: 580-622-3781

discosales@discoautomotive.com







CNP58

04/28/21

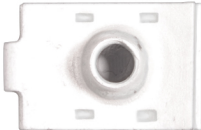

# COOL NEW PRODUCTS

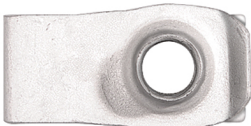
## G.M. Clips & Fasteners





### Nuts Extruded "U"

<b>16078PK</b>	4.2-1.41 Screw Size 2 - 3mm Panel Range 9.50mm Center of Hole to Edge Zinc Organic Extruded "U" Nuts G.M. # 11548579	<b>25 Pcs.</b>		
<b>16081PK</b>	6-1.00 Screw Size .70 - 2mm Panel Range 14mm Center of Hole to Edge Zinc Organic Extruded "U" Nuts G.M. # 11611321	<b>10 Pcs.</b>		
<b>16080PK</b>	8-1.25 Screw Size .80 - 4mm Panel Range 21mm Center of Hole to Edge Zinc Finish Extruded "U" Nuts Ford # W520813-S439 G.M. # 11516150	<b>15 Pcs.</b>		



### Nuts Specialty

<b>15902PK</b>	6-1.00mm Screw Size 12mm Overall Height Organic Zinc Finish Front Fender Panel Nuts G.M. # 11610544	<b>10 Pcs.</b>		
----------------	-----------------------------------------------------------------------------------------------------------------	----------------	--------------------------------------------------------------------------------------	--------------------------------------------------------------------------------------

### Rivets Automotive

<b>15170PK</b>	5/32" (4mm) Rivet Diameter 7/16" Flange Diameter 3/64" - 3/8" Grip Range Alum Rivet S/Steel Mandrel Front & Rear Bumper Rivets G.M. # 9132667	<b>25 Pcs.</b>		
<b>10962PK</b>	3/16" (4.70mm) Rivet Diameter 5/8" Flange Diameter 1/4" - 3/8" Grip Range Black Finish All Steel Fascia To Bumper Rivets G.M. # 9439719	<b>50 Pcs.</b>		

### Retainers Door Trim Panel

<b>16091PK</b>	23/64" (9mm) Hole Size 17mm Stem Length 15mm Top Head Diameter Natural Nylon With Sealer Door Trim Panel Retainers G.M. # 11549307	<b>15 Pcs.</b>		
----------------	---------------------------------------------------------------------------------------------------------------------------------------------------	----------------	--------------------------------------------------------------------------------------	---------------------------------------------------------------------------------------

**Disco** Automotive Hardware

Ph: 580-622-3090

Fax: 580-622-3781

discosales@discoautomotive.com

CNP59

06/09/21

# COOL NEW PRODUCTS

## G.M. Clips & Fasteners

### Retainers Moulding

**18263PK** 23/64" (9mm) Hole Size  
11mm Stem Length  
12.50 x 23mm Top Head  
White Nylon  
Tailgate Cover Retainers  
G.M. # 11611626

25 Pcs.

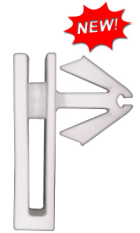

**16087PK** 25/64" (10mm) Hole Size  
17mm Stem Length  
22 x 46mm Head Size  
Green Nylon  
Rocker Moulding Retainers  
G.M. # 25744385

15 Pcs.



## Ford Clips & Fasteners

### Nuts Specialty

**12053PK** 5 - .80mm Thread Size  
8mm Hex Size  
10mm O.D. Loose Washer  
Yellow Zinc Finish  
Metric Hex Nuts  
Ford # N802775-S36

50 Pcs.



### Retainers Hood Insulation

**16082PK** 17mm Overall Height  
15mm Stem Length  
25 x 30mm Head Size  
Black Nylon  
Hood Insulation Retainers  
Ford # W716783-S300

25 Pcs.



### Retainers Trim Panel

**16083PK** 9/32" (7mm) Hole Size  
45mm Stem Length  
18mm Head Diameter  
Black Nylon  
Trim Panel Retainers  
Ford # W719084-S300

25 Pcs.

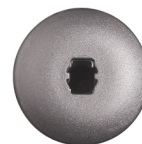

### Retainers Moulding

**15943PK** 3/8" (9.50mm) Hole Size  
14mm Stem Length  
13mm Top Head Diameter  
Black Nylon With Sealer  
Rear Bumper Retainers  
Ford # W718033-S300

10 Pcs.



*Disco* Automotive Hardware

Ph: 580-622-3090

Fax: 580-622-3781

discosales@discoautomotive.com

CNP60

06/09/21

# COOL NEW PRODUCTS

## Electrical Products

### Cable Ties



**12019PK**      6" Length .140" Width      **100 Pcs.**  
1.42" Max Bundle Diameter  
40 lbs. Tensile Strength  
Black Nylon  
Cable Ties

### Cable Ties Mounts

**16053PK**      Use with # 6 Flat Head Screw      **100 Pcs.**  
Accepts 18 lb To 50 lb Ties  
4 Way Insertion Natural Nylon  
3/4" Square Cable Tie Mount  
With Adhesive



**16054PK**      Use with # 6 Flat Head Screw      **100 Pcs.**  
Accepts 18 lb To 50 lb Ties  
4 Way Insertion Natural Nylon  
1" Square Cable Tie Mount  
With Adhesive



## G.M. Clips & Fasteners

### Retainers Moulding

**16093PK**      23/64" (9mm) Hole Size      **10 Pcs.**  
10mm Stem Length  
12 x 20mm  
Green Nylon With Sealer  
Moulding Retainers  
G.M. # 11547210



## Hyundai Clips & Fasteners

### Rivets Automotive

**16077PK**      1/8" (3.20mm) Diameter      **25 Pcs.**  
6.30mm Flange Size  
4.00mm-7.90mm Grip Range  
Black Aluminum Rivet Steel Mandrel  
Front & Rear Bumper Rivets  
Hyundai # 14160-03133



*Disco* Automotive Hardware

Ph: 580-622-3090

Fax: 580-622-3781

discosales@discoautomotive.com

CNP61

10/15/21

# COOL NEW PRODUCTS

## Mercedes Clips & Fasteners

### Retainers Moulding

**16072PK**

51/64" (20mm) Hole Size  
16mm Stem Length  
24mm Head Diameter  
White Nylon  
Rocker Moulding Retainers  
Use With # 9587  
Mercedes # 000-991-72-98

15 Pcs.

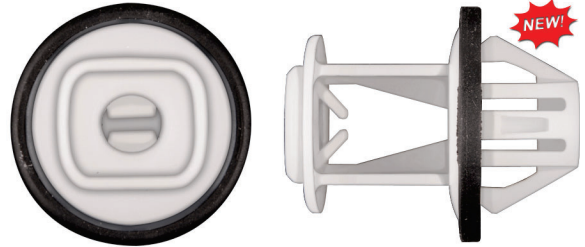

**9587PK**

1/4" (6.50mm) Hole Size  
7mm Stem Length  
31mm Slotted Head Diameter  
Black Nylon  
Rocker Moulding Retainers  
Use With # 16072  
Mercedes # 000-991-74-98

15 Pcs.

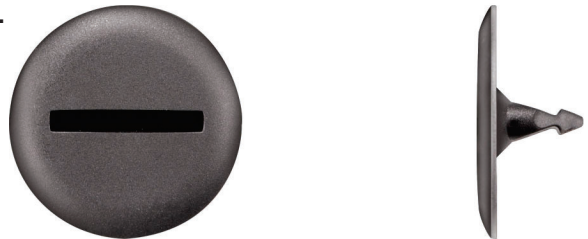

## Nissan Clips & Fasteners

### Retainers Weatherstrip

**16067PK**

15/64" (6mm) Hole Size  
12mm Stem Length  
7 x 16mm Head Size  
Blue Nylon  
Weatherstrip Retainers  
Nissan # 01553-09311

25 Pcs.



## Toyota Clips & Fasteners

### Clips Retaining

**16098PK**

43mm Overall Length  
39mm Overall Width  
Black Nylon  
Bumper to Fender  
Liner Clips  
Toyota # 53879-02150, 53879-33030

5 Pcs.



*Disco* Automotive Hardware

Ph: 580-622-3090

Fax: 580-622-3781

discosales@discoautomotive.com

CNP62

10/15/21

# COOL NEW PRODUCTS

## Chrysler Clips & Fasteners

### Nuts Specialty

**18265PK**

6-1.00 Screw Size  
10mm Stem Length  
15mm Square Hole Size  
14.50 x 21mm Head Size  
Magni-554 Finish  
Door & Fender Nuts  
Chrysler # 6506955AA

**10 Pcs.**

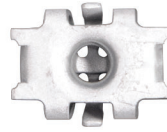

### Nuts Extruded "U"

**16079PK**

6-1.00mm Screw Size  
.80 - 4.00mm Panel Range  
13.50mm Center of Hole to Edge  
Zinc Organic  
Extruded U Nut  
Chrysler # 6510185-AA, 6101956, 6503694  
Ford # W520822-S439

**25 Pcs.**



### Retainers Push Type

**18264PK**

1/4" (6.30mm) Hole Size  
14mm Stem Length  
14mm Top Head Diameter  
Black Nylon  
Spoiler Retainers  
Chrysler # 6502632

**15 Pcs.**



### Retainer Door Trim Panel

**16074PK**

23/64"(9mm) Hole Size  
13mm Stem Length  
22mm Flange Diameter  
Yellow & White Nylon  
Door Panel Retainers  
Chrysler # 6510766-AA

**15 Pcs.**



### Retainers Moulding

**18450PK**

23/64" (9mm) Hole Size  
12mm Stem Length  
12mm Stem Length  
14.50 x 38mm Top Head Size  
White Nylon  
Wheel Flare Retainers

**10 Pcs.**

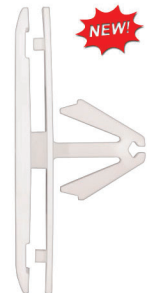

**Disco** Automotive Hardware

Ph: 580-622-3090

Fax: 580-622-3781

discosales@discoautomotive.com

CNP63

10/15/21

# COOL NEW PRODUCTS

## Sales Aids

### Boards Sample

**SB16023**

Weatherstrip Retainers,  
Nylon Nuts, Screw Grommets,  
Door & Moulding Retainers,  
Retaining Clips  
Toyota Sample Board

Sold Each



**SB16024**

Extruded "U" Nuts,  
Bumper Clips & Pins &  
Hood, Shield,  
Push & Screw Type Retainers  
Toyota Sample Board

Sold Each

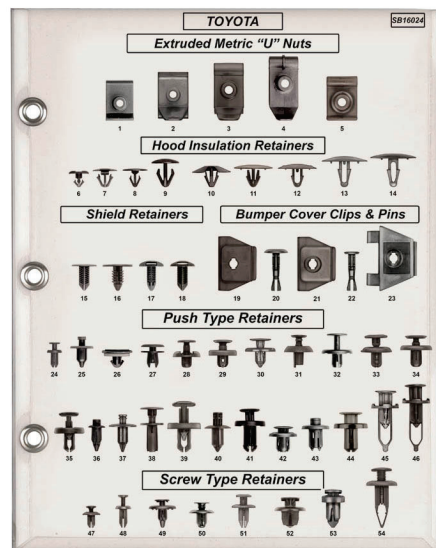

*Disco* Automotive Hardware

Ph: 580-622-3090

Fax: 580-622-3781

discosales@discoautomotive.com

CNP64



# COOL NEW PRODUCTS

## Sales Aids

### Boards Sample

**SB16025**

Weatherstrip, Door &  
Moulding Retainers,  
Screw Grommets &  
Nylon Nuts  
Honda Sample Board

Sold Each

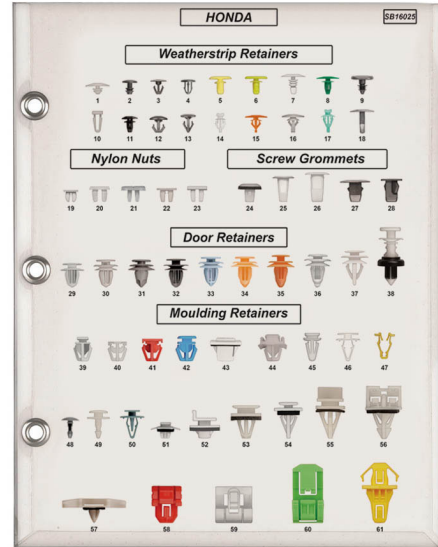

**SB16026**

Shield, Hood Insulation,  
Push & Screw Retainers  
Honda Sample Board

Sold Each

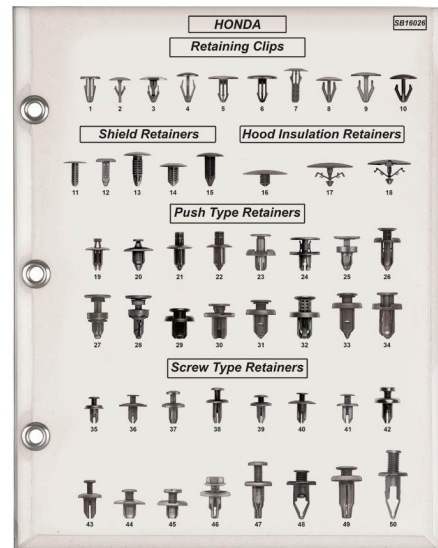

*Disco* Automotive Hardware

Ph: 580-622-3090

Fax: 580-622-3781

discosales@discoautomotive.com

CNP65

# COOL NEW PRODUCTS

## Sales Aids

### Boards Sample

**SB16027**

Weatherstrip,  
Nylon Nut,  
Screw Grommet,  
Door & Moulding Retainers  
Nissan Sample Board

Sold Each

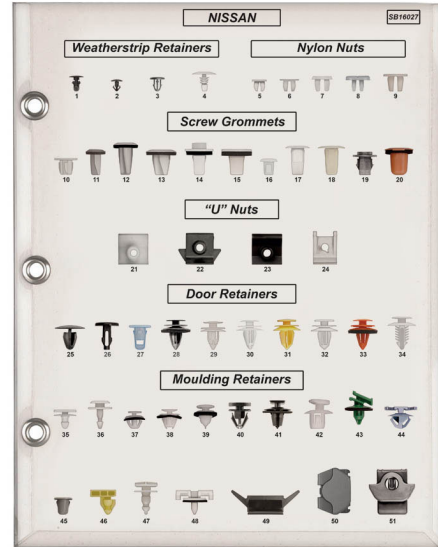

**SB16028**

Shield, Hood Insulation,  
Screw & Push Type  
Retainers  
Nissan Sample Board

Sold Each

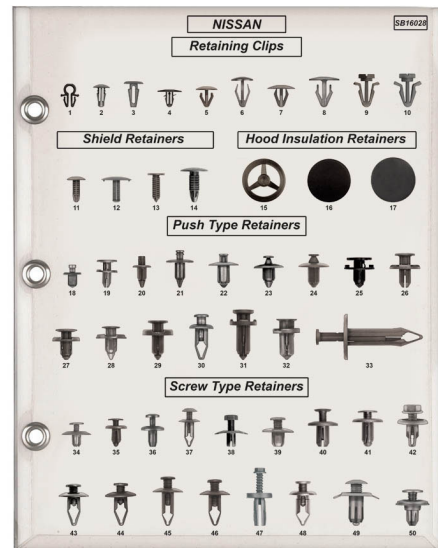

*Disco* Automotive Hardware

Ph: 580-622-3090

Fax: 580-622-3781

discosales@discoautomotive.com

CNP66

# COOL NEW PRODUCTS

## Sales Aids

### Boards Sample

**SB16029**

Nylon Nuts, Door,  
Moulding &  
Weatherstrip Retainers  
Ford Sample Board

Sold Each



**SB16030**

Push, Screw Type &  
Hood Retainers  
Ford Sample Board

Sold Each

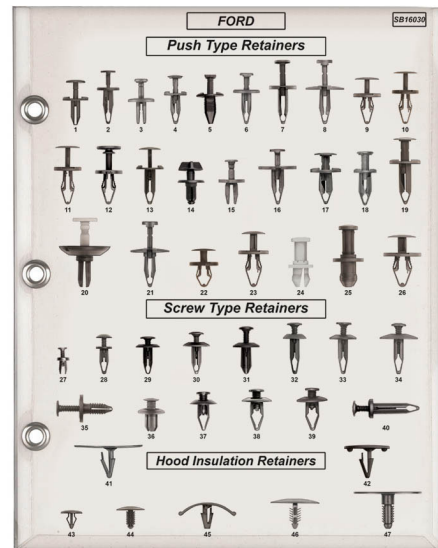

*Disco* Automotive Hardware

Ph: 580-622-3090

Fax: 580-622-3781

discosales@discoautomotive.com

CNP67

# COOL NEW PRODUCTS

## Sales Aids

### Boards Sample

**SB16031**

Door & Moulding Retainers  
Volkswagen Sample Board

Sold Each



**SB16032**

Nylon Nut,  
Hood, Skid Plate,  
Push & Screw Type  
Retainers  
Volkswagen Sample Board

Sold Each

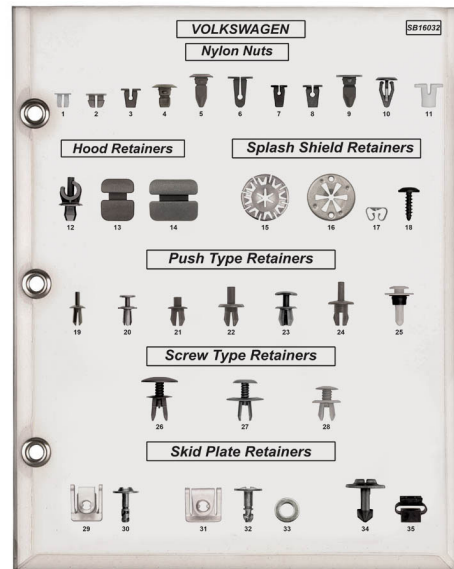

*Disco* Automotive Hardware

Ph: 580-622-3090

Fax: 580-622-3781

discosales@discoautomotive.com

CNP68

# COOL NEW PRODUCTS

## Sales Aids

### Boards Sample

**SB16033**

Nut &  
Screw Grommets,  
Door, Moulding, Weatherstrip,  
Push & Screw Type Retainers  
Hyundai Sample Board

Sold Each

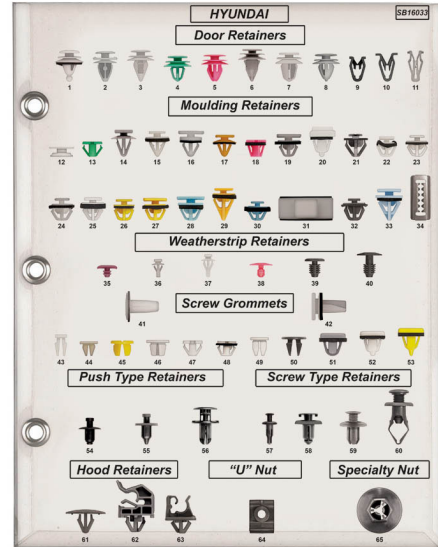

**SB16034**

Push On Type,  
Shield & Weatherstrip  
Retainers  
Chrysler Sample Board

Sold Each

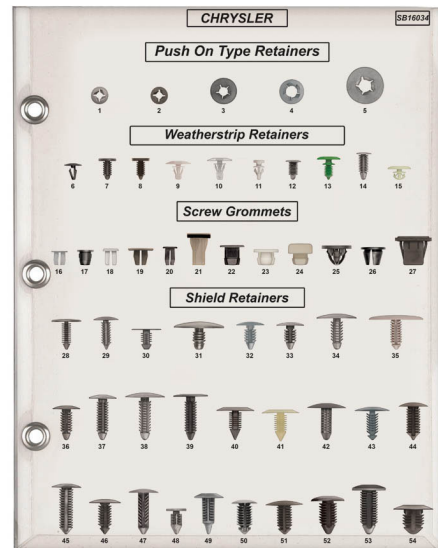

*Disco* Automotive Hardware

Ph: 580-622-3090

Fax: 580-622-3781

discosales@discoautomotive.com

CNP69

# COOL NEW PRODUCTS

## Sales Aids

### Boards Sample

**SB16035**

Push & Screw Type,  
Hood Retainers  
Chrysler Sample Board

Sold Each

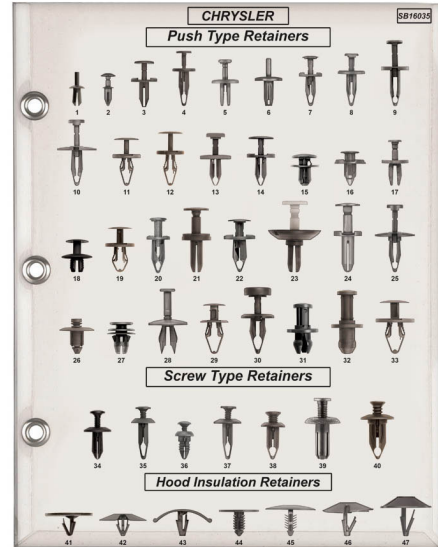

**SB16036**

Nutserts,  
Door & Moulding  
Retainers  
Chrysler Sample Board

Sold Each

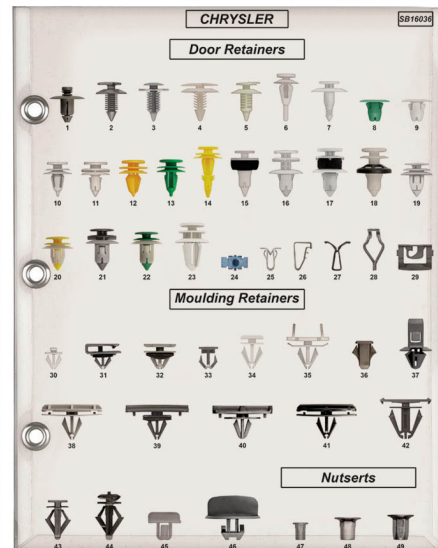

*Disco* Automotive Hardware

Ph: 580-622-3090

Fax: 580-622-3781

discosales@discoautomotive.com

CNP70

# COOL NEW PRODUCTS

## Sales Aids

### Boards Sample

**SB16037**

Nuts,  
Push On Type,  
& Weatherstrip Retainers  
General Motors Sample Board

**Sold Each**

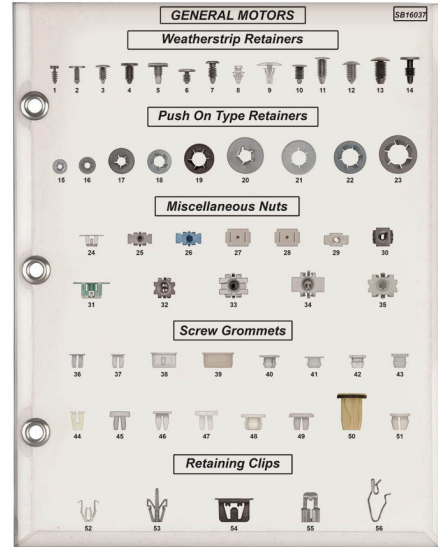

**SB16038**

Push Type Retainers  
General Motors Sample Board

**Sold Each**



*Disco* Automotive Hardware

Ph: 580-622-3090

Fax: 580-622-3781

discosales@discoautomotive.com

CNP71

# COOL NEW PRODUCTS

## Sales Aids

### Boards Sample

**SB16039**

Shield & Screw Type Retainers  
General Motors Sample Board

**Sold Each**



**SB16040**

Door Panel Retainers  
General Motors Sample Board

**Sold Each**



*Disco* Automotive Hardware

Ph: 580-622-3090

Fax: 580-622-3781

[discosales@discoautomotive.com](mailto:discosales@discoautomotive.com)

CNP72



# COOL NEW PRODUCTS

## Sales Aids

### Boards Sample

**SB16041**

Flange & Loose Washer  
Hex Nuts, Nutserts,  
Rubber Well Nuts,  
Bushings & Hood Retainers  
General Motors Sample Board

**Sold Each**

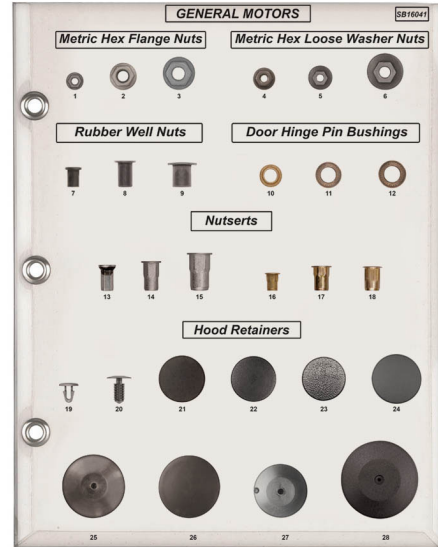

**SB16042**

Moulding Retainers  
General Motors Sample Board

**Sold Each**



*Disco* Automotive Hardware

Ph: 580-622-3090

Fax: 580-622-3781

discosales@discoautomotive.com

CNP73

# COOL NEW PRODUCTS

## Sales Aids

### Boards Sample

**SB16043**

1/2" to 1" O.D. &  
11mm to 20mm O.D.  
Oil Drain Gasket Sample Board

Sold Each



**SB16044**

1/2-20,  
12-1.25mm, 12-1.75mm,  
14-1.25mm, 14-1.50mm  
Thread Sizes  
Oil Drain Plug Sample Board

Sold Each



*Disco* Automotive Hardware

Ph: 580-622-3090

Fax: 580-622-3781

discosales@discoautomotive.com

CNP74

# COOL NEW PRODUCTS

## G.M. Clips & Fasteners

### Retainers Grommets

**16309PK**

25/64" (10mm) Hole Size  
17.50mm Overall Length  
19mm Head Diameter  
Orange Nylon With Sealer  
Tail Lamp Grommets  
G.M. # 84221533

**10 Pcs.**



### Retainers Door Trim Panel

**16311PK**

1/4" (6.50mm) Hole Size  
9.30mm Stem Length  
15mm Flange Diameter  
White Nylon With Sealer  
Interior Door Trim &  
Exterior Moulding Retainers  
G.M. # 11610700

**15 Pcs.**



## Ford Clips & Fasteners

### Nuts Nylon

**16308PK**

15/64" (6.00mm) Screw Size  
23mm Stem Length  
15mm Square Head  
10mm Hole Size  
Gray Nylon With Sealer  
License Plate Grommets  
Ford # W714172-S300

**15 Pcs.**



### Retainers Shield

**16312PK**

21/64" (8.50mm) Hole Size  
63.50mm Stem Length  
30mm Head Diameter  
Gray Nylon  
Headliner Retainers  
Ford # W717918-SS34X

**15 Pcs.**

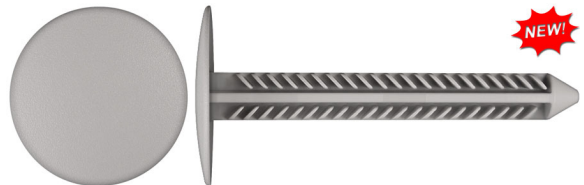

Not Actual Size

### Retainers Push Type

**16313PK**

1/4" (6.30mm) Hole Size  
18mm Stem Length  
14mm Head Diameter  
Black Nylon  
Cowl Vent  
Push Type Retainers  
Ford # W703243-S300

**10 Pcs.**



*Disco* Automotive Hardware

Ph: 580-622-3090

Fax: 580-622-3781

discosales@discoautomotive.com

CNP75

# COOL NEW PRODUCTS

## Specialty Nuts

### Nuts License Plate

9597PK

6-1.00mm Screw Size  
Zinc Organic  
License Plate Nuts  
G.M. # 15707256

10 Pc.



## Assortments

### Assortments Metric Hex Flange Bolt



Contains 24 Difernt Size  
229 Total Pieces  
6mm To 10mm Screw Size  
Class 10.9 Hex Flange  
Nuts & Bolts Assortment

BACK OF TRAY					
# 8716 Bright Zinc Finish 10.9 Grade Metric Hex Flange Bolt Assortment					
3200PK 6 - 1.00mm Class 10 10mm Hex, 14mm Serrated Flange Bright Zinc Finish Metric Spin Lock Nuts JIS B1189 1	3201PK 8 - 1.25mm Class 10 12mm Hex, 17mm Serrated Flange Bright Zinc Finish Metric Spin Lock Nuts JIS B1190 2	17946PK 10 - 1.50mm Class 10 15mm Hex, 21.3mm Serrated Flange Bright Zinc Finish Metric Spin Lock Nuts	3203PK 6 - 1.00 x 12mm Class 10.9 10mm Hex, 14mm Flange Bright Zinc Finish Metric Flange Bolts JIS B1189 3	3204PK 6 - 1.00 x 16mm Class 10.9 10mm Hex, 14mm Flange Bright Zinc Finish Metric Flange Bolts JIS B1189 4	17950PK 10 - 1.50 x 30mm Class 10.9 15mm Hex, 22.3mm Flange Bright Zinc Finish Metric Flange Bolts
3205PK 6 - 1.00 x 20mm Class 10.9 10mm Hex, 14mm Flange Bright Zinc Finish Metric Flange Bolts JIS B1189 7	3206PK 6 - 1.00 x 25mm Class 10.9 10mm Hex, 14mm Flange Bright Zinc Finish Metric Flange Bolts	3207PK 6 - 1.00 x 30mm Class 10.9 10mm Hex, 14mm Flange Bright Zinc Finish Metric Flange Bolts JIS B1189 9	3208PK 6 - 1.00 x 35mm Class 10.9 10mm Hex, 14mm Flange Bright Zinc Finish Metric Flange Bolts JIS B1189 10	3209PK 6 - 1.00 x 40mm Class 10.9 10mm Hex, 14mm Flange Bright Zinc Finish Metric Flange Bolts JIS B1189 11	17951PK 10 - 1.50 x 35mm Class 10.9 15mm Hex, 22.3mm Flange Bright Zinc Finish Metric Flange Bolts
9824PK 6 - 1.00 x 45mm Class 10.9 10mm Hex, 14mm Flange Bright Zinc Finish Metric Flange Bolts JIS B1189 13	3210PK 8 - 1.25 x 12mm Class 10.9 12mm Hex, 17.50mm Flange Bright Zinc Finish Metric Flange Bolts JIS B1189 14	3211PK 8 - 1.25 x 16mm Class 10.9 12mm Hex, 17.50mm Flange Bright Zinc Finish Metric Flange Bolts JIS B1189 15	3212PK 8 - 1.25 x 20mm Class 10.9 12mm Hex, 17.50mm Flange Bright Zinc Finish Metric Flange Bolts JIS B1189 16	3213PK 8 - 1.25 x 25mm Class 10.9 12mm Hex, 17.50mm Flange Bright Zinc Finish Metric Flange Bolts JIS B1189 17	17952PK 10 - 1.50 x 40mm Class 10.9 15mm Hex, 22.3mm Flange Bright Zinc Finish Metric Flange Bolts
3214PK 8 - 1.25 x 30mm Class 10.9 12mm Hex, 17.50mm Flange Bright Zinc Finish Metric Flange Bolts JIS B1189 19	3215PK 8 - 1.25 x 35mm Class 10.9 12mm Hex, 17.50mm Flange Bright Zinc Finish Metric Flange Bolts JIS B1189 20	3216PK 8 - 1.25 x 40mm Class 10.9 12mm Hex, 17.50mm Flange Bright Zinc Finish Metric Flange Bolts JIS B1189 21	17948PK 10 - 1.50 x 20mm Class 10.9 15mm Hex, 22.3mm Flange Bright Zinc Finish Metric Flange Bolts	17949PK 10 - 1.50 x 25mm Class 10.9 15mm Hex, 22.3mm Flange Bright Zinc Finish Metric Flange Bolts	17953PK 10 - 1.50 x 45mm Class 10.9 15mm Hex, 22.3mm Flange Bright Zinc Finish Metric Flange Bolts
FRONT OF TRAY					



Part #	Tray Type	Material	Tray #	Tray Color	Lid Color	Label Type	Clear Pocket	Qty.	
8716	24 Hole	Plastic	80123	Gray	Gray	Adhesive	No	1 Pc.	NEW
8716BCP	24 Hole	Plastic	80155BCP	Dark Blue	Clear	Paper	Yes	1 Pc.	NEW
8716GCP	24 Hole	Plastic	80123GCP	Gray	Clear	Paper	Yes	1 Pc.	NEW
8716RCP	24 Hole	Plastic	80152RCP	Red	Clear	Paper	Yes	1 Pc.	NEW
8716YCP	24 Hole	Plastic	80123YCP	Yellow	Clear	Paper	Yes	1 Pc.	NEW

*Disco* Automotive Hardware

Ph: 580-622-3090

Fax: 580-622-3781

discosales@discoautomotive.com

CNP76

# COOL NEW PRODUCTS

## Specialty Nuts

### Nuts Emblem

**18451PK**

5mm Stud Size  
10mm Hex Size  
15mm Flange Diameter  
Zinc Finish  
Locking Teeth  
Emblem Nuts  
Ford # W706675-S439

**50 Pcs.**



### Nuts Hex Loose Washer Metric

**12055PK**

6 - 1.00mm Screw Size  
11mm Hex Size  
24mm O.D. Loose Washer  
Yellow Zinc Finish  
Metric Hex Nuts  
Ford # N621907, N621907-S55

**25 Pcs.**



### Nuts Keys®



Part #	Thread Size	Hex Size	Finish	Qty.	
16133PK	6-32	5/16"	Zinc	100 Pcs.	New
16134PK	8-32	11/32"	Zinc	100 Pcs.	New
16135PK	10-24	3/8"	Zinc	100 Pcs.	New
16136PK	10-32	3/8"	Zinc	100 Pcs.	New
16137PK	12-24	7/16"	Zinc	100 Pcs.	New
16138PK	1/4-20	7/16"	Zinc	100 Pcs.	New
16140PK	3/8-16	9/16"	Zinc	100 Pcs.	New
16139PK	5/16-18	1/2"	Zinc	100 Pcs.	New

### Nuts Extruded "U" Type Metric

**16075PK**

8-1.25mm Screw Size  
.80mm-4.00mm Panel Range  
14.50mm Center of Hole to Edge  
Zinc Finish  
Extruded "U" Nuts  
Ford # W520823-S439, N800296-S439

**15 Pcs.**



*Disco* Automotive Hardware

Ph: 580-622-3090

Fax: 580-622-3781

discosales@discoautomotive.com

CNP77

# COOL NEW PRODUCTS

## Specialty Nuts

### Hex Nuts

**11896PK** 6-1.00mm Screw Size  
11mm Hex Size  
19mm O.D. Loose Washer  
Black Finish  
Metric Hex Nuts  
G.M. # 11503754, 11503756, 11505005,  
11517293, 11609411

25 Pcs.



### Nuts Extruded Type "U" Metric

**11981PK** #8 (4.2-1.41) Screw Size  
1.80mm-3.50mm Panel Range  
9.50mm Center of Hole to Edge  
Zinc Organic  
Metric "U" Nuts  
Ford # W716567-S439

25 Pcs.

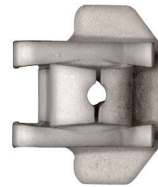

**16095PK** 6 - 1.00mm Screw Size  
.50mm - 4.00mm Panel Range  
13mm Center of Hole to Edge  
Silver Finish  
Extruded "U" Nuts  
Chrysler # 6105242-AA

25 Pcs.

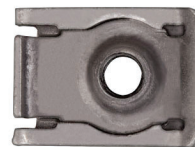

## Service Equipment

### Storage Bins, Stand



80378



80383

Part #	Width	Depth	Height	Finish	Use With	Qty.	
80378	33 3/4"	12 1/4"	5 3/4"	Gray	# 80372 & 80375	1 Pc.	<b>NEW</b>
80383	33 3/4"	12 1/4"	12"	Gray	# 80372 & 80375	1 Pc.	<b>NEW</b>

*Disco* Automotive Hardware

Ph: 580-622-3090

Fax: 580-622-3781

discosales@discoautomotive.com

CNP78

# COOL NEW PRODUCTS

## Screws

### Screws Phillips Hex Head Sems®

**11867PK** 5-1.59 x 16mm  
8mm Indented Hex Head  
16mm O.D. Loose Washer  
Black Finish  
Phillips Sems® Screws



### Screw Phillips Oval Loose Washer Head Sems® Trim

**5764PK** 10 x 5/8" # 8 Head  
Phillips Oval Loose Washer  
15/32" O.D. Washer  
Chrome Finish  
Sems® Trim Screws



## G.M. Clips & Fasteners

### Clips Moulding

**16310PK** 8mm Width  
15mm Height  
White Nylon  
Quarter Panel &  
Exterior Trim Moulding Clips  
Ford # W714972-S300  
GM # 94748652



## Assortments

### Assortment G.M. Specialty Nut

# 8219 G.M. Specialty Nut Assortment					
# 9199PK <p>#8 Screw Size Zinc Finish Aluminum Steel Radiator Grille Nuts</p>	# 11032PK <p>#8 (4.20mm) Screw Size .70mm x 2.30mm Panel Range 8.70mm Hole Size Blue Finish MFI Panel Nuts</p>	# 12983PK <p>#8 (4.20mm) Screw Size 6mm x 16mm Head Size 7mm Overall Height Magni-565 Finish Front Bumper Nuts</p>	# 11258PK <p>#8 (4.20mm) Screw Size 8.65mm Hole Size Zinc Finish Fender Bracket Push In Nuts</p>	# 10143PK <p>17/32" (13.50mm) Hole Size 11mm Overall Length Headlamp Assembly Nuts</p>	# 16065PK <p>#8 (4.20mm) Screw Size 0.5mm-1.0mm Panel Range 8.55mm Square Hole Size Green Finish W/Silicone Pad Door Panel &amp; Bumper Nuts</p>
# 11034PK <p>#8 (4.20mm) Screw Size 9 x 11mm Hole Size Black Finish Dash Panel Nuts</p>	# 18094PK <p>6-1.00 Screw Size .70mm-3.80mm Panel Range 9.25 x 13.75mm Hole Size Zinc Finish Rear Bumper Bracket Nuts</p>	# 15691PK <p>4.2-1.41 #8 Screw Size Zinc Organic Center Console Door, Front Lights, Grille, Lift Gate Nuts W/Silicone Pad</p>	# 15902PK <p>6-1.00mm Screw Size 12mm O.A. Height Organic Zinc Finish Front Fender Panel Nuts</p>	# 15864PK <p>4.2 x 1.41 Screw Size 10.90 x 13mm Hole Size 1.40-5mm Panel Range Green Metallic Finish Bracket Retainer Nuts</p>	# 13423PK <p>6-1.00 Thread Size 11mm O.A. Height Zinc Organic Radiator Grille &amp; Front End Panel Nuts</p>



**8219** Contains 12 Different Sizes  
180 Total Pieces  
6 3/4" x 11" Plastic Tray  
Used on G.M. Cars & Trucks  
Specialty Nut Assortment

1 Pc.

**Disco** Automotive Hardware

Ph: 580-622-3090

Fax: 580-622-3781

discosales@discoautomotive.com

CNP79

# COOL NEW PRODUCTS

## Specialty Nuts

### Nuts Miscellaneous

**16065PK** #8 (4.20mm) Screw Size  
.50mm-1.00mm Panel Range  
8.55mm Square Hole Size  
Green Finish W/Silicone Pad  
Door Panel & Bumper Nuts  
G.M. # 11546868

15 Pcs.



**16314PK** 6-1.00 Screw Size  
9/16" (14mm) Square Hole  
16.25mm Overall Length  
Black Finish Bumper,  
Door Glass & Grille Nuts  
Chrysler # 6505223AA

10 Pcs.



## Hole Plug

### Hole Plugs Locking Type Black

**16325PK** 1 1/2" Hole Size  
1 43/64" Head Diameter  
1/8" Max Panel Thickness  
Black Nylon Flush Type  
Locking Hole Plugs

25 Pcs.



## Retainers Windshield & Cowl

### Clips Windshield Moulding

**16307PK** 43mm Overall Height  
18mm Overall Width  
White & Black Nylon  
Windshield & Interior Trim  
Moulding Clips  
Honda # 91561-TV1-E11

50 Pcs.

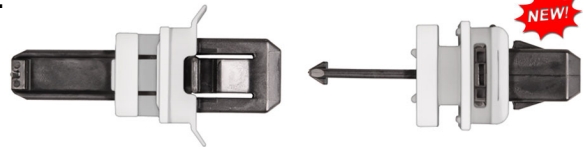

Not Actual Size

*Disco* Automotive Hardware

Ph: 580-622-3090

Fax: 580-622-3781

discosales@discoautomotive.com

CNP80



# COOL NEW PRODUCTS

## Specialty Nuts

### Nuts Extruded "U"

**16328PK**

6-1.00 Screw Size  
0.70mm-2.00mm Panel Range  
12mm Center of Hole to Edge  
Zinc Finish  
Speed Type "U" Nuts  
Ford # W712324-S439

10 Pcs.



### Nuts Nylon

**16359PK**

4mm Screw Size  
1 1/32" (8.50mm) Hole Size  
9.70mm Stem Length  
9.50mm Head Size  
Gray Nylon With Sealer  
Screw Grommets  
Honda # 90656-SJK-J01

15 Pcs.



## Sales Aids

### Display Poster Wall

**1EDP**

Oil Drain Hardware  
Displayed on a 28" x 40"  
English Wall Poster

Sold Each

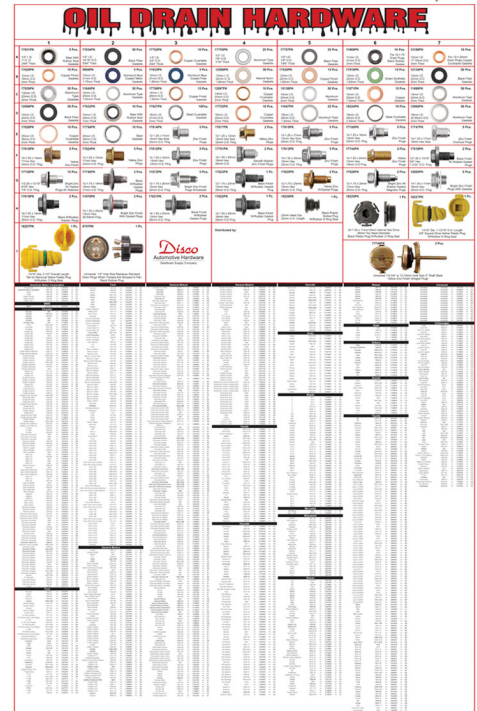

**Disco** Automotive Hardware

Ph: 580-622-3090

Fax: 580-622-3781

discosales@discoautomotive.com

CNP81

# COOL NEW PRODUCTS

## Specialty Nuts

### Nuts Extruded Type "U" Metric

**16365PK**

6-1.00 Screw Size  
1.80mm - 2.20mm Panel Range  
9.20mm Center of Hole to Edge  
Zinc Organic  
Extruded "U" Nuts  
Chrysler # 68073566AA

15 Pcs.



## Door Fasteners

### Retainers Door Trim Panel

**16358PK**

11/32" (8.50mm) Hole Size  
21.10mm Flange Diameter  
24.10mm Overall Length  
Black Nylon With Sealer  
Tailgate Spoiler Retainers  
Honda # 91513-T6A-003

15 Pcs.



**16363PK**

23/64" (9mm) Hole Size  
18.50mm Stem Length  
16mm Top Head Size  
Black & White Nylon  
Door Panel Retainers  
Chrysler # 6510359AA

15 Pcs.



**16362PK**

23/64" (9mm) Hole Size  
18.50mm Stem Length  
16mm Top Head Size  
Black & Yellow Nylon  
Door Panel Retainers  
Chrysler # 6510747AA

15 Pcs.



## Ford Clips & Fasteners

### Retainers Push Type

**15015PK**

3/8" (9.50mm) Hole Size  
11mm Stem Length  
14 x 40mm Head Size  
Black Nylon  
Rocker Moulding Retainers  
Ford # F57Z-16241-AB, W709767-S300

15 Pcs.



*Disco* Automotive Hardware

Ph: 580-622-3090

Fax: 580-622-3781

discosales@discoautomotive.com

CNP82

# COOL NEW PRODUCTS

## Rivets

### Rivets Automotive All Steel

**11093PK**      3/16" Diameter  
23/64" Flange Diameter      **25 Pcs.**  
5/8 - 3/4" Grip Range  
All Steel  
Pop Rivets  
Industrial # 612



**NEW!**

## Chrysler Clips & Fasteners

### Retainers Push Type

**16338PK**      5/16" (8mm) Hole Size  
20mm Stem Length      **25 Pcs.**  
20mm Head Diameter  
Black Nylon  
Bumper & Apron  
Push Type Retainers  
Chrysler # MU001220  
Mitsubishi # MU000695



**NEW!**

**16393PK**      25/64" (10mm) Hole Size  
13.40mm Stem Length      **15 Pcs.**  
20mm Head Diameter  
Black Nylon  
Tail Lamp Mounting  
Push Type Retainers  
Chrysler # 6512734AA



**NEW!**

## Honda Clips & Fasteners

### Nuts Nylon

**16342PK**      #8 (4.20mm) Screw Size  
10mm Stem Length      **25 Pcs.**  
14 x 28mm Head Diameter  
5/16" (8mm) Hole Size  
White Nylon  
Bumper Retainers  
Honda # 90101-SHJ-A01



**NEW!**

### Retainers Moulding

**16332PK**      12mm Width  
40mm Length      **25 Pcs.**  
15mm Overall Height  
White Nylon With Adhesive Strip  
Windshield Moulding Retainers  
Honda # 91568-TA0-A00



**NEW!**

*Disco* Automotive Hardware

Ph: 580-622-3090

Fax: 580-622-3781

discosales@discoautomotive.com

CNP83

# COOL NEW PRODUCTS

## Specialty Nuts

### Nuts Extruded Type "U" Metric

**16099PK**

8-1.25mm Screw Size  
3mm Panel Range  
27.30mm Center of Hole to Edge  
Silver Magni Finish  
Fender Panel Extruded "U" Nuts  
G.M. # 11569971

5 Pcs.

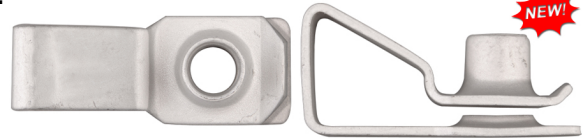

Not Actual Size

### Nuts Nylon Type "U" Metric

**16329PK**

#8 (4.20mm) Screw Size  
1mm Panel Range  
11mm Center of Hole to Edge  
Natural Nylon Fender & Bumper  
Moulding "U" Nuts  
BMW # 07-14-7-311-312

25 Pcs.



## Push & Screw Type Retainers

### Retainers Push Type

**16084PK**

7/32" (5.60mm) Hole Size  
12.70mm Stem Length  
9.50mm Head Size  
Black Nylon  
Body Side Moulding  
Push Type Retainers  
G.M. # 20363491

25 Pcs.



## Hyundai Clips & Fasteners

### Clips Routing Cable

**16337PK**

5/16" (8mm) Hole Size  
19mm Overall Height  
Holds 7mm Diameter Cable  
Black Nylon  
Hood Release Cable Clips  
Hyundai # 81199-33000

25 Pcs.



**16336PK**

5/16" (8mm) Hole Size  
19.70mm Overall Height  
Holds 7mm Diameter Cable  
Black Nylon  
Hood Release Cable Clips  
Hyundai # 81199-38000

25 Pcs.



*Disco* Automotive Hardware

Ph: 580-622-3090

Fax: 580-622-3781

discosales@discoautomotive.com

CNP84

# COOL NEW PRODUCTS

## Assortments

### Complete Body Shop

**8414:** Made up of 3 steel cabinets, 1 base, and the following 12 Assortments



Full Cabinet Dimensions:  
51 1/4" High, 23 1/2" Wide, 22 1/2" Deep  
Drawer Inside Dimensions:  
20 5/8 x 21 1/4"

- 8877: Black Nylon Shield Retainers**  
Contains 26 Different Parts, 570 Total Pcs. 4mm to 10mm Diameter Range Black Nylon Shield Retainers
- 8878: Weatherstrip & Hood Retainers**  
Contains 29 Different Parts, 625 Total Pcs. Nylon Weatherstrip & Hood Retainers
- 8879: Black Nylon Push & Screw Type Retainers**  
Contains 32 Different Parts, 435 Total Pcs. 5mm to 7.1mm Diameter Range Black Nylon Push & Screw Retainers
- 8880: Black Nylon Push Type Retainers**  
Contains 32 Different Parts, 320 Total Pcs. 8mm to 10mm Diameter Range Black Nylon Push Retainers
- 8881: Door Trim Panel & Moulding Retainers**  
Contains 33 Different Parts, 380 Total Pcs. Door Trim Panel & Moulding Retainers
- 8882: Nylon & Metal Retaining Nuts**  
Contains 34 Different Parts, 425 Total Pcs. Nylon & Metal Retaining Nuts
- 8883: Sheet Metal Screws**  
Contains 32 Different Parts, 740 Total Pcs. Phillips, Hex & Torx® Head Sheet Metal Screws
- 8884: Hex Nut, U Nut & Body Bolts**  
Contains 31 Different Parts, 550 Total Pcs. Hex Loose Washer Nuts & Body Bolts
- 8885: Nylon, Aluminum & Steel Pop Rivets**  
Contains 32 Different Parts, 630 Total Pcs. Nylon, Aluminum & Steel Pop Rivets
- 8886: Black Nylon Tie Straps**  
Contains 7 Different Parts, 300 Total Pcs. Black Nylon Tie Straps
- 8887: Wire Terminals & Small Assortments**  
Contains 46 Different Parts, 648 Total Pcs. Wire Terminals & Small Assortments
- 8888: Bulbs & Headlamps**  
Contains 32 Different Parts, 221 Total Pcs. Wedge & Round Base Bulbs & Headlamps



**80371**  
Empty Cabinet



Single Assortment

Cabinets and assortments listed are available for individual purchase.



**8414** Contains 366 Different Items  
5844 Total Pieces  
Fastening System  
Complete Body Shop Assortment

Sold Each

**Disco** Automotive Hardware

Ph: 580-622-3090

Fax: 580-622-3781

discosales@discoautomotive.com

CNP85

# COOL NEW PRODUCTS

## Service Equipment

### Small Cabinets

**80350:** For any small Disco Assortment that uses tray size 6 3/4x 11"



- Sits on work bench or Mount on wall
- Strong, lightweight ABS plastic
- Notched shelves for easy access
- Built in handle



Proudly made  
in the USA



#### Link Cabinets Together with:

- Tongue and Groove Design
- Aligned holes on top and bottom
- Push type pins included



**80350**

11 1/4" Width  
6 3/4" Depth  
10 3/4" Height  
Gray Finish  
Small Plastic Cabinet

**Sold Each**

*Disco* Automotive Hardware

Ph: 580-622-3090

Fax: 580-622-3781

discosales@discoautomotive.com

CNP 86

# COOL NEW PRODUCTS

## Screws

### Screws Indented Hex Head Sems® Black Finish

18254PK

4.2-1.41 x 20mm  
7mm Indented Hex Head  
16mm Outside Diameter Loose Washer  
Black Finish  
Trim Screws

50 Pcs.



## Shield, Hood & Weatherstrip Retainers

### Retainers Shield

5648NPK

25/64" (10mm) Hole Size  
30mm Stem Length  
22mm Head Diameter  
.040-.790" Panel Range  
Natural Nylon  
Shield Retainers

50 Pcs.

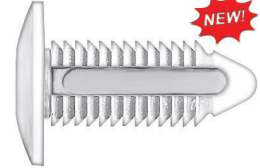

### Retainers Weatherstrip

16453PK

13/64" (5mm) Hole Size  
8mm Stem Length  
5 x 15mm Top Head Size  
Yellow Nylon  
Weatherstrip Retainers

50 Pcs.



## Chrysler Clips & Fasteners

### Nuts Hex Loose Washer Metric

13503PK

6-1.00mm Thread Size  
10mm Hex Size  
18mm Outside Diameter Loose Washer  
Black Finish  
Metric Hex Nuts  
Chrysler # 6100048, 6500284

50 Pcs.



## Honda Clips & Fasteners

### Screws Trim

10246PK

M5-1.81 x 20mm  
Phillips Flat Top  
13mm Head Diameter  
Black Finish  
Trim Screws  
Honda 90103-SDA-A00, 90103-TA0-000

100 Pcs.



**Disco** Automotive Hardware

Ph: 580-622-3090

Fax: 580-622-3781

discosales@discoautomotive.com

CNP87

# COOL NEW PRODUCTS

## G.M. Clips & Fasteners

### Retainers Grommets

**16447PK** 11/64" (4.50mm) Hole Size  
5mm Stem Length  
28mm Head Diameter  
Black Nylon  
Bumper Cover Grommets  
G.M. # 15265199

25 Pcs.



NEW!



**16450PK** 5mm Stud  
8mm Stem Length  
30mm Head Diameter  
Black Nylon  
Wheel House Liner Retainers  
GM # 94530387

25 Pcs.



NEW!



**16446PK** 28mm Top Diameter  
17.50mm Bottom Diameter  
23mm Overall Height  
Black Nylon  
Body Mount Cushion Sleeves  
G.M. # 15924986

25 Pcs.



NEW!



### Bumpers

**16449PK** 7/16" (11mm) Slot Size  
27mm Overall Height  
20mm Overall Width  
Black Rubber  
Hood Prop Buffer  
G.M. # 22755704

25 Pcs.



NEW!



### Retainers Weatherstrip

**16448PK** 13/64" (5mm) Hole Size  
4.70 x 7mm Stem Size  
6.50 x 14mm Top Head Size  
Green Nylon  
Door Weatherstrip Retainers  
G.M. # 11611664

25 Pcs.



NEW!



*Disco* Automotive Hardware

Ph: 580-622-3090

Fax: 580-622-3781

discosales@discoautomotive.com

CNP88



# COOL NEW PRODUCTS

## Tesla Clips & Fasteners

### Retainers Door Panel

**16459PK**

5/16" (7.90mm) Hole Size  
12mm Stem Length  
22mm Top Head Size  
Black & White With Sealer  
Front & Rear Door  
Trim Panel Retainers  
Tesla # 1135147-00-A, 1135147-S0-B

**25 Pcs.**



### Retainers Windshield & Cowl

**16462PK**

13/32" (10.30mm) Hole Size  
9.50mm Stem Length  
15mm Top Head Size  
White Nylon  
Cowl & Luggage Retainers  
Tesla # 1092696-00-B

**50 Pcs.**



## Subaru Clips & Fasteners

### Grommets Grille Cowl

**16387PK**

9/32" (7mm) Hole Size  
7.30mm Stem Length  
16mm Head Diameter  
Gray Nylon  
Cowl Grille Grommets  
Use With # 12094  
Subaru # 91486FL020

**25 Pcs.**



**12094PK**

3mm Pin Diameter  
13mm Stem Length  
16 x 18mm Head Size  
Black Nylon  
Cowl Retainers  
Use With # 12093 or 16387  
Subaru # 91486-KJ010

**25 Pcs.**

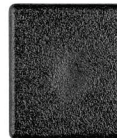

### Clips Routing Cable or Tubing

**16401PK**

25/64" (10mm) Hole Size  
20mm Overall Height  
Holds 5mm Diameter Cable  
Black Nylon  
Trunk Release Cable Clips  
Subaru # 909205056

**25 Pcs.**

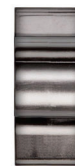

**Disco** Automotive Hardware

Ph: 580-622-3090

Fax: 580-622-3781







discosales@discoautomotive.com

CNP89





# COOL NEW PRODUCTS

## Honda Clips & Fasteners

### Nuts Nylon

<b>16455PK</b>	5/16" (8mm) Hole Size 14mm Stem Length 18mm Head Diameter Blue Nylon With Sealer Tail Light Grommets Honda # 91626-TA0-A01	<b>25 Pcs.</b>		
<b>16456PK</b>	5/16" (8mm) Hole Size 13mm Stem Length 13mm Head Diameter White Nylon With Sealer Cowl & Wheelhouse Screw Grommets Honda # 90601-S30-003	<b>25 Pcs.</b>		
<b>16374PK</b>	7/16" (11mm) Hole Size 14mm Stem Length 16mm Head Diameter Natural Nylon With Sealer Screw Grommets Honda # 90601-SNV-P01	<b>25 Pcs.</b>		

### Retainers Shield

<b>16458PK</b>	5/32" (4mm) Hole Size 15mm Stem Length 18mm Head Diameter Black Nylon Fender Liner Retainers Honda # 91501-T2A-003	<b>25 Pcs.</b>		
<b>16464PK</b>	15/64" (6mm) Hole Size 10mm Stem Length 13mm Head Diameter Black Nylon Front Cowl Retainers Honda # 91501-SL4-003	<b>25 Pcs.</b>		

### Hole Plugs Depressed Center Door Hole Type Black Nylon Metric



Part #	Hole Size	Head Size	Overall Height	O.E.M.	Qty.
<b>16334PK</b>	20mm	29mm	8.50mm	Honda # 95551-20000	<b>25 Pcs. NEW</b>
<b>16333PK</b>	20mm	29mm	9.50mm	Honda # 90820-SNA-003	<b>25 Pcs. NEW</b>

**Disco** Automotive Hardware

Ph: 580-622-3090

Fax: 580-622-3781

discosales@discoautomotive.com

CNP90

# COOL NEW PRODUCTS

## Chrysler Clips & Fasteners

### Clips Routing Cable or Tubing

12052PK

1/4" Diameter Tube  
5/16" Stem Diameter  
Black Nylon Engine  
Compartment Wire Clips  
Chrysler # 25512081

25 Pcs.



### Retainer Door Trim Panel

16382PK

19/64" (7.50mm) Hole Size  
15mm Stem Length  
22mm Top Head Diameter  
White & Yellow With Sealer  
Door Panel Retainers  
Fiat # 51987227  
Jeep # 6511618AA

25 Pcs.



16410PK

19/64" (7.50mm) Hole Size  
27.50mm Stem Length  
13mm Top Head Size  
Turquoise Nylon  
Lift Gate Retainers  
Chrysler # 68087885AA

25 Pcs.

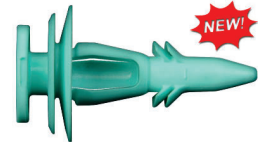

### Retainers Moulding

16372PK

21/64" (8.50mm) Hole Size  
11mm Stem Length  
12mm Square Top Head Size  
Blue Nylon With Sealer  
Fender & Wheel Moulding Retainer  
Chrysler # 5SR17JXWAA  
Fiat # 735537083

25 Pcs.



## Volvo Clips & Fasteners

### Retainers Moulding

16386PK

11/32" (8.50mm) Hole Size  
8mm Stem Length  
15mm Top Head Diameter  
Orange Nylon  
Fender Flare Retainers  
Volvo # 8659732

25 Pcs.



**Disco** Automotive Hardware

Ph: 580-622-3090

Fax: 580-622-3781

discosales@discoautomotive.com

CNP91

# COOL NEW PRODUCTS

## BMW Clips & Fasteners

### Retainers Push Type

**16330PK**

5/16" (8mm) Hole Size  
19mm Stem Length  
25mm Head Diameter  
Black Nylon  
Rocker Moulding  
Push Type Retainers  
BMW # 07-14-7-281-961

25 Pcs.



### Retainers Door Trim Panel

**16403PK**

15/64" (6mm) Hole Size  
10mm Stem Length  
9 x 12mm Head Size  
Yellow Nylon  
Door Sill Retainers  
BMW # 51-47-8-244-458

50 Pcs.



### Retainers Moulding

**16371PK**

5/16" (8mm) Hole Size  
10.50mm Stem Length  
16mm Top Head Size  
Black Nylon  
Liftgate Trim Retainers  
BMW # 07-14-7-236-400

25 Pcs.



### Retainers Phillips Screw

**16404PK**

9/32" (7mm) Hole Size  
11mm Stem Length  
20mm Head Diameter  
Black Nylon  
Hood Insulator & Rear Bumper  
Push Type Retainers  
BMW # 51-48-1-915-964

50 Pcs.



## Fiat Clips & Fasteners

### Nuts Nylon

**16373PK**

5mm Screw Size  
12mm Stem Length  
26mm Head Diameter  
8 x 12.50mm Hole Size  
White Nylon  
Rocker Moulding Screw Grommets  
Fiat # 68080648AA

25 Pcs.



**Disco** Automotive Hardware

Ph: 580-622-3090

Fax: 580-622-3781

discosales@discoautomotive.com

CNP92

# COOL NEW PRODUCTS

## Toyota Clips & Fasteners

### Retainers Push Type

**16142PK** 9/32" (7mm) Hole Size  
9mm Stem Length  
19mm Flange Diameter  
Black Nylon  
Access Cover, Air Deflector &  
Side Shield Push Type Retainers  
Toyota # 90467-07217

25 Pcs.



### Nuts Nylon

**16399PK** 23/64" (9mm) Hole Size  
8mm Stem Length  
17mm Head Diameter  
Yellow Nylon  
Headlamp Assembly Grommets  
Toyota # 90189-06238

25 Pcs.

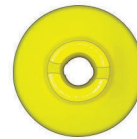

### Retainers Moulding

**16353PK** 23/64" (9mm) Hole Size  
19mm Stem Length  
13mm Top Head Size  
Yellow Nylon With Sealer  
Rocker Moulding Retainers  
Toyota # 75868-60020

25 Pcs.



**16390PK** 1/2" (12.70mm) Hole Size  
23mm Stem Length  
17 x 37mm Head Diameter  
Black Nylon  
Bumper to Fender Retainers  
Use With Disco # 16098  
Toyota # 47749-33030, 47749-02020

25 Pcs.



**16098PK** 43mm Overall Length  
39mm Overall Width  
Black Nylon  
Bumper to Fender  
Liner Clips  
Use With Disco # 16390  
Toyota # 53879-02150, 53879-33030

5 Pcs.



*Disco* Automotive Hardware

Ph: 580-622-3090

Fax: 580-622-3781

discosales@discoautomotive.com

CNP93

# COOL NEW PRODUCTS

## Nissan Clips & Fasteners

### Nuts Nylon "U" Type with Metal Insert Metric

16369PK

6-1.00 Screw Size  
3.50mm Panel Range  
13.50mm Center of Hole to Edge  
Black Nylon & Black Metal  
License Plate Bracket "U" Nuts  
Nissan # 01241-01051

25 Pcs.



### Retainers Door Trim Panel

16376PK

15/64" (6mm) Hole Size  
19mm Stem Length  
17 x 20mm Head Size  
Yellow Nylon  
Door Insulator Retainers  
Nissan # 80897-7J100

25 Pcs.



## Mercedes Clips & Fasteners

### Nuts Specialty

16367PK

4.8-1.61mm Screw Size  
30mm Flange Diameter  
10mm Hex Head Size  
Black Nylon Fender Liner,  
Apron, & Under Cover  
Hex Flange Nuts  
Mercedes # 000-990-31-62

25 Pcs.



### Hole Plugs

16356PK

9/32" (7mm) Hole Size  
6mm Stem Length  
10mm Head Size  
Black Rubber  
Trunk Lid Hole Plugs  
Mercedes # 002-998-16-50

50 Pcs.



### Retainers Push Type

16406PK

9/32" (7mm) Hole Size  
19mm Stem Length  
20mm Head Size  
Black Nylon  
Rear Fender Liner  
Push Type Retainers  
Mercedes # 000-991-41-40

25 Pcs.



**Disco** Automotive Hardware

Ph: 580-622-3090

Fax: 580-622-3781

discosales@discoautomotive.com

CNP94

# COOL NEW PRODUCTS

## Ford Clips & Fasteners

### Nuts Extruded "U"

16471PK

6-1.00mm Screw Size  
.50mm-2.30mm Panel Range  
14.50mm Center of Hole to Edge  
Zinc Organic  
Extruded "U" Nuts  
Ford # W705958-S439

10 Pcs.



### Clips Door Rod End Clips

16391PK

#10-24 Rod Size  
2mm Panel Range  
8mm Hole Size  
Gray Nylon  
Door Lock & Tailgate Rod Clips  
Ford # F65Z-1521952-AA,  
F7DZ-7421952-AA  
G.M. # 16629990, 16675980, 16640343

15 Pcs.

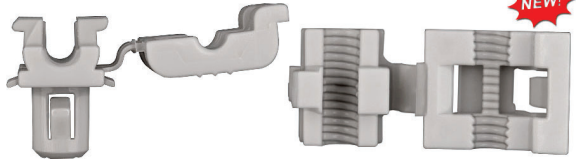

## Land Rover Clips & Fasteners

### Retainers Door Trim Panel

16375PK

5/16" (8mm) Hole Size  
15mm Stem Length  
14.50mm Top Head Size  
White Nylon With Sealer  
Trim Panel, Tailgate &  
Luggage Compartment Retainer  
Land Rover # LR013135

15 Pcs.



### Retainers Moulding

16460PK

23/64" (9mm) Hole Size  
15mm Stem Length  
15.50mm Head Diameter  
Black Nylon  
Pillar Post Moulding Retainers  
Land Rover # LR002229

25 Pcs.



16461PK

15/64" (6mm) Hole Size  
13mm Stem Length  
13mm Head Diameter  
Black Nylon  
Pillar, Rocker & Floor Moulding  
Push Type Retainers  
Land Rover # LR033144

15 Pcs.



**Disco** Automotive Hardware

Ph: 580-622-3090

Fax: 580-622-3781





discosales@discoautomotive.com

CNP95



# COOL NEW PRODUCTS

## Mazda Clips & Fasteners



### Nuts Specialty

<b>16383PK</b>	3.50mm Stud Size 12mm Outside Diameter Stainless Steel Emblem Push Nuts Mazda # 9957-83-000	<b>50 Pcs.</b>		
<b>16380PK</b>	2.50mm Stud Size 8mm Head Diameter 6mm Hole Size Clear Nylon With Sealer Emblem Tubular Nuts Mazda # LA01-51-958	<b>25 Pcs.</b>		
<b>16335PK</b>	5 x 20mm Screw Size 10mm Stem Length 18mm Flange Diameter 21/64" (8.50mm) Hole Size Phillips Truss Head Screw & Nylon Tail Lamp Grommets Mazda # GJ6A-51-14Y	<b>15 Pcs.</b>		



### Retainers Weatherstrip

<b>16339PK</b>	13/64" (5mm) Hole Size 10mm Stem Length 5 x 11mm Head Size White Nylon Weatherstrip Retainers Mazda # KD45-58-762	<b>25 Pcs.</b>		
----------------	----------------------------------------------------------------------------------------------------------------------------------	----------------	--------------------------------------------------------------------------------------	--------------------------------------------------------------------------------------

### Retainers Push Type

<b>16341PK</b>	15/64" (6mm) Hole Size 14mm Stem Length 18mm Head Diameter Black Nylon Rear Trunk Liner Push Type Retainers Mazda # B467-68-AC3-02	<b>25 Pcs.</b>		
----------------	------------------------------------------------------------------------------------------------------------------------------------------------------	----------------	--------------------------------------------------------------------------------------	---------------------------------------------------------------------------------------

### Clips Hood Release Cable

<b>16379PK</b>	8mm Rod Size 9 x 12mm Hole Size 26mm Overall Length Black Nylon Hood Prop Rod Clips Mazda # L206-56-652A	<b>25 Pcs.</b>		
----------------	-------------------------------------------------------------------------------------------------------------------------	----------------	--------------------------------------------------------------------------------------	---------------------------------------------------------------------------------------

*Disco* Automotive Hardware

Ph: 580-622-3090

Fax: 580-622-3781

discosales@discoautomotive.com

CNP96



# COOL NEW PRODUCTS

## G.M. Clips & Fasteners

### Retainers Door Trim Panel

**16408PK** 5/16" (8mm) Hole Size  
14mm Stem Length  
15mm Top Head Size  
Yellow Nylon With Sealer  
Trim Panel Retainers  
G.M. # 11546588, 11547577

15 Pcs.



**16392PK** 8.25 x 17.50mm Slot Size  
8.60mm Stem Length  
16 x 22mm Head Size  
White Nylon  
Trim Retainers  
G.M.# 11603036

25 Pcs.



### Retainers Moulding

**16397PK** 23/64" (9mm) Hole Size  
12mm Stem Length  
33 x 45.50mm Top Head  
White Nylon With Sealer  
Rocker Moulding Retainers  
G.M. # 11601845

10 Pcs.

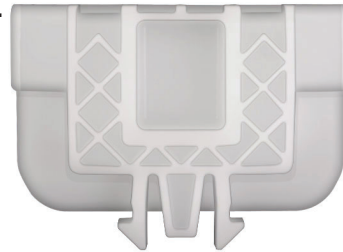

**16348PK** 9 x 20mm Hole Size  
15mm Stem Length  
33 x 45mm Top Head Size  
White Nylon  
Rocker Panel Moulding Retainers  
G.M. # 11549137

10 Pcs.

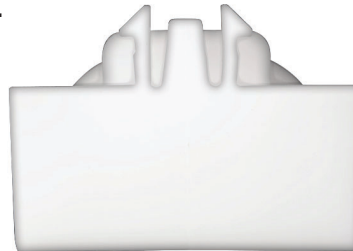

### Nuts Extruded Type "U" Metric

**16400PK** 6-1.00mm Screw Size  
1.80mm-2.50mm Panel Range  
9mm Center of Hole to Edge  
Zinc Finish  
Extruded "U" Nuts  
Ford # N806728-S439  
G.M. # 11517841

15 Pcs.



*Disco* Automotive Hardware

Ph: 580-622-3090

Fax: 580-622-3781

discosales@discoautomotive.com

CNP97

# COOL NEW PRODUCTS

## Honda Clips & Fasteners

### Retainers Push Type

**16360PK** 11/32" (8.50mm) Hole Size  
12.30mm Stem Length  
18mm Flange Diameter  
Black & White Nylon  
Pillar Garnish Retainers  
Honda # 91561-TVA-A01

15 Pcs.

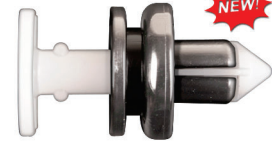

### Retainers Door Trim Panel

**16340PK** 23/64" (9mm) Hole Size  
11mm Stem Length  
13mm Top Head Diameter  
Green Nylon  
Door Panel & Trim Retainers  
Honda # 91560-SZW-003

25 Pcs.



**16394PK** 11mm Hole Size  
9mm Stem Length  
12mm x 15mm Top Head Size  
White Nylon W/Sealer Lower  
Door Garnish Moulding Retainers  
Honda # 75315-TP6-A01

25 Pcs.



### Retainers Head Lamp

**16366PK** 7mm Width  
20mm Length  
17mm Overall Height  
Black Nylon  
Head Lamp Moulding Retainers  
Honda # 33152-TLA-A01

25 Pcs.



### Clips Moulding

**16355PK** 15mm Width  
75mm Length  
Gray Nylon  
Windshield Moulding Retainers  
Honda # 91570-TA5-A01

25 Pcs.



Not Actual Size

**16384PK** 9.50mm Hole Diameter  
32mm Length  
22mm Width  
Black Nylon Fender &  
Engine Under Cover Clips  
Honda # 90501-SJA-A01

25 Pcs.



**Disco** Automotive Hardware

Ph: 580-622-3090

Fax: 580-622-3781

discosales@discoautomotive.com

CNP98

# COOL NEW PRODUCTS

## Stainless Steel Fasteners

### Cap Screws Class 18-8 (300 Series) Hex Head Stainless Steel



18-8 (300 Series) Stainless Steel

U.S.S. Coarse Thread

Part #	Size	Hex Size	Qty.
18475PK	1/4-20 x 1/2"	7/16"	50 Pcs. <b>NEW</b>
18477PK	1/4-20 x 3/4"	7/16"	50 Pcs. <b>NEW</b>
18478PK	1/4-20 x 1"	7/16"	50 Pcs. <b>NEW</b>
18479PK	1/4-20 x 1 1/4"	7/16"	50 Pcs. <b>NEW</b>
18480PK	1/4-20 x 1 1/2"	7/16"	50 Pcs. <b>NEW</b>
18481PK	1/4-20 x 1 3/4"	7/16"	50 Pcs. <b>NEW</b>
18482PK	1/4-20 x 2"	7/16"	25 Pcs. <b>NEW</b>
18483PK	1/4-20 x 2 1/4"	7/16"	25 Pcs. <b>NEW</b>
18484PK	1/4-20 x 2 1/2"	7/16"	25 Pcs. <b>NEW</b>
18485PK	1/4-20 x 2 3/4"	7/16"	25 Pcs. <b>NEW</b>
18486PK	1/4-20 x 3"	7/16"	25 Pcs. <b>NEW</b>
18493PK	5/16-18 x 1/2"	1/2"	50 Pcs. <b>NEW</b>
18495PK	5/16-18 x 3/4"	1/2"	50 Pcs. <b>NEW</b>
18496PK	5/16-18 x 1"	1/2"	50 Pcs. <b>NEW</b>
18497PK	5/16-18 x 1 1/4"	1/2"	25 Pcs. <b>NEW</b>
18498PK	5/16-18 x 1 1/2"	1/2"	25 Pcs. <b>NEW</b>
18499PK	5/16-18 x 1 3/4"	1/2"	25 Pcs. <b>NEW</b>
18500PK	5/16-18 x 2"	1/2"	25 Pcs. <b>NEW</b>
18501PK	5/16-18 x 2 1/4"	1/2"	25 Pcs. <b>NEW</b>
18502PK	5/16-18 x 2 1/2"	1/2"	25 Pcs. <b>NEW</b>
18503PK	5/16-18 x 2 3/4"	1/2"	25 Pcs. <b>NEW</b>
18504PK	5/16-18 x 3"	1/2"	25 Pcs. <b>NEW</b>
18511PK	3/8-16 x 1/2"	9/16"	50 Pcs. <b>NEW</b>
18513PK	3/8-18 x 3/4"	9/16"	50 Pcs. <b>NEW</b>
18514PK	3/8-16 x 1"	9/16"	50 Pcs. <b>NEW</b>
18515PK	3/8-18 x 1 1/4"	9/16"	25 Pcs. <b>NEW</b>
18516PK	3/8-18 x 1 1/2"	9/16"	25 Pcs. <b>NEW</b>

Part #	Size	Hex Size	Qty.
18517PK	3/8-16 x 1 3/4"	9/16"	25 Pcs. <b>NEW</b>
18518PK	3/8-16 x 2"	9/16"	25 Pcs. <b>NEW</b>
18519PK	3/8-16 x 2 1/4"	9/16"	25 Pcs. <b>NEW</b>
18520PK	3/8-16 x 2 1/2"	9/16"	25 Pcs. <b>NEW</b>
18521PK	3/8-16 x 2 3/4"	9/16"	25 Pcs. <b>NEW</b>
18522PK	3/8-16 x 3"	9/16"	25 Pcs. <b>NEW</b>
18529PK	7/16-14 x 3/4"	5/8"	25 Pcs. <b>NEW</b>
18530PK	7/16-14 x 1"	5/8"	25 Pcs. <b>NEW</b>
18531PK	7/16-14 x 1 1/4"	5/8"	25 Pcs. <b>NEW</b>
18532PK	7/16-14 x 1 1/2"	5/8"	15 Pcs. <b>NEW</b>
18533PK	7/16-14 x 1 3/4"	5/8"	15 Pcs. <b>NEW</b>
18534PK	7/16-14 x 2"	5/8"	15 Pcs. <b>NEW</b>
18535PK	7/16-14 x 2 1/4"	5/8"	15 Pcs. <b>NEW</b>
18536PK	7/16-14 x 2 1/2"	5/8"	15 Pcs. <b>NEW</b>
18537PK	7/16-14 x 2 3/4"	5/8"	10 Pcs. <b>NEW</b>
18538PK	7/16-14 x 3"	5/8"	10 Pcs. <b>NEW</b>
18545PK	1/2-13 x 3/4"	3/4"	10 Pcs. <b>NEW</b>
18546PK	1/2-13 x 1"	3/4"	10 Pcs. <b>NEW</b>
18547PK	1/2-13 x 1 1/4"	3/4"	10 Pcs. <b>NEW</b>
18548PK	1/2-13 x 1 1/2"	3/4"	10 Pcs. <b>NEW</b>
18549PK	1/2-13 x 1 3/4"	3/4"	10 Pcs. <b>NEW</b>
18550PK	1/2-13 x 2"	3/4"	10 Pcs. <b>NEW</b>
18551PK	1/2-13 x 2 1/4"	3/4"	10 Pcs. <b>NEW</b>
18552PK	1/2-13 x 2 1/2"	3/4"	10 Pcs. <b>NEW</b>
18553PK	1/2-13 x 2 3/4"	3/4"	10 Pcs. <b>NEW</b>
18554PK	1/2-13 x 3"	3/4"	10 Pcs. <b>NEW</b>

*Disco* Automotive Hardware

Ph: 580-622-3090

Fax: 580-622-3781

discosales@discoautomotive.com

CNP99

# COOL NEW PRODUCTS

## Stainless Steel Fasteners

### Washers Flat Class 18-8 (300 Series) Stainless Steel



Part #	Size	Inside Diameter	Outside Diameter	Thickness	Qty.	
18648PK	1/4"	9/32"	5/8"	.050"	100 Pcs.	NEW
18649PK	5/16"	11/32"	3/4"	.050"	100 Pcs.	NEW
18650PK	3/8"	13/32"	7/8"	.050"	50 Pcs.	NEW
18651PK	7/16"	1/2"	1 1/8"	.062"	50 Pcs.	NEW
18652PK	1/2"	17/32"	1 1/4"	.062"	50 Pcs.	NEW

### Washers Lock Class 18-8 (300 Series) Stainless Steel



Part #	Size	Type	Qty.	
18662PK	1/4"	Split Lock Washers	100 Pcs.	NEW
18663PK	5/16"	Split Lock Washers	100 Pcs.	NEW
18664PK	3/8"	Split Lock Washers	50 Pcs.	NEW
18665PK	7/16"	Split Lock Washers	25 Pcs.	NEW
18666PK	1/2"	Split Lock Washers	25 Pcs.	NEW

### Nuts Hex Coarse Thread Class 18-8 (300 Series) Stainless Steel



Part #	Screw Size	Hex Size	Type	Qty.	
18634PK	1/4-20	7/16"	USS	100 Pcs.	NEW
18635PK	5/16-18	1/2"	USS	50 Pcs.	NEW
18636PK	3/8-16	9/16"	USS	50 Pcs.	NEW
18637PK	7/16-14	11/16"	USS	25 Pcs.	NEW
18638PK	1/2-13	3/4"	USS	25 Pcs.	NEW

**Disco** Automotive Hardware

Ph: 580-622-3090

Fax: 580-622-3781

discosales@discoautomotive.com

CNP100

# COOL NEW PRODUCTS

## Stainless Steel Fasteners

**Nuts Hex Coarse Thread Nylon Lock Insert Class 18-8 (300 Series) Stainless Steel**



Part #	Size	Hex Size	Finish	Qty.	
18672PK	1/4-20	7/16"	USS	100 Pcs.	NEW
18673PK	5/16-18	1/2"	USS	50 Pcs.	NEW
18674PK	3/8-16	9/16"	USS	50 Pcs.	NEW
18675PK	7/16-14	11/16"	USS	25 Pcs.	NEW
18676PK	1/2-13	3/4"	USS	25 Pcs.	NEW

**Screws Phillips Pan Head Machine 18-8 Stainless Steel**



Part #	Screw Size	Qty.		Part #	Screw Size	Qty.	
18688PK	6-32 x 1/2"	100 Pcs.	NEW	18706PK	10-24 x 1 1/2"	25 Pcs.	NEW
18689PK	6-32 x 3/4"	100 Pcs.	NEW	18707PK	10-24 x 1 3/4"	25 Pcs.	NEW
18690PK	6-32 x 1"	100 Pcs.	NEW	18708PK	10-24 x 2"	25 Pcs.	NEW
18691PK	6-32 x 1 1/4"	100 Pcs.	NEW	18709PK	12-24 x 1/2"	50 Pcs.	NEW
18692PK	6-32 x 1 1/2"	50 Pcs.	NEW	18710PK	12-24 x 3/4"	50 Pcs.	NEW
18693PK	6-32 x 1 3/4"	50 Pcs.	NEW	18711PK	12-24 x 1"	50 Pcs.	NEW
18694PK	6-32 x 2"	50 Pcs.	NEW	18712PK	12-24 x 1 1/4"	25 Pcs.	NEW
18695PK	8-32 x 1/2"	100 Pcs.	NEW	18713PK	12-24 x 1 1/2"	25 Pcs.	NEW
18696PK	8-32 x 3/4"	100 Pcs.	NEW	18714PK	12-24 x 1 3/4"	25 Pcs.	NEW
18697PK	8-32 x 1"	100 Pcs.	NEW	18715PK	12-24 x 2"	25 Pcs.	NEW
18698PK	8-32 x 1 1/4"	50 Pcs.	NEW	18716PK	1/4-20 x 1/2"	50 Pcs.	NEW
18699PK	8-32 x 1 1/2"	25 Pcs.	NEW	18717PK	1/4-20 x 3/4"	50 Pcs.	NEW
18700PK	8-32 x 1 3/4"	25 Pcs.	NEW	18718PK	1/4-20 x 1"	50 Pcs.	NEW
18701PK	8-32 x 2"	25 Pcs.	NEW	18719PK	1/4-20 x 1 1/4"	25 Pcs.	NEW
18702PK	10-24 x 1/2"	100 Pcs.	NEW	18720PK	1/4-20 x 1 1/2"	25 Pcs.	NEW
18703PK	10-24 x 3/4"	100 Pcs.	NEW	18721PK	1/4-20 x 1 3/4"	25 Pcs.	NEW
18704PK	10-24 x 1"	100 Pcs.	NEW	18722PK	1/4-20 x 2"	25 Pcs.	NEW
18705PK	10-24 x 1 1/4"	50 Pcs.	NEW				

**Disco** Automotive Hardware

Ph: 580-622-3090

Fax: 580-622-3781

discosales@discoautomotive.com

CNP101

# COOL NEW PRODUCTS

## Stainless Steel Fasteners

### Washers Flat Stainless Steel



Part #	Size	Inside Diameter	Outside Diameter	Thickness	Qty.	
18644PK	#6 (1/8")	9/64"	3/8"	.031	100 Pcs.	NEW
18645PK	#8 (5/32")	11/64"	3/8"	.031	100 Pcs.	NEW
18646PK	#10 (3/16")	13/64"	7/16"	.062	100 Pcs.	NEW
18647PK	#12 (7/32")	1/4"	9/16"	.050	100 Pcs.	NEW

### Washers Lock Stainless Steel



Part #	Size	Type	Qty.	
18658PK	#6 (1/8")	Split Washers	100 Pcs.	NEW
18659PK	#8 (5/32")	Split Washers	100 Pcs.	NEW
18660PK	#10 (3/16")	Split Washers	100 Pcs.	NEW
18661PK	#12 (7/32")	Split Washers	100 Pcs.	NEW

### Nuts Hex Machine Screw Stainless Steel



Part #	Screw Size	Hex Size	Qty.	
18628PK	6-32	5/16"	100 Pcs.	NEW
18629PK	8-32	11/32"	100 Pcs.	NEW
18630PK	10-24	3/8"	100 Pcs.	NEW
18631PK	10-32	3/8"	100 Pcs.	NEW
18632PK	12-24	7/16"	100 Pcs.	NEW
18633PK	14-20	7/16"	100 Pcs.	NEW

### Nuts Hex Machine Screw Nylon Lock Stainless Steel



Part #	Screw Size	Hex Size	Qty.	
18682PK	6-32	5/16"	100 Pcs.	NEW
18683PK	8-32	11/32"	100 Pcs.	NEW
18684PK	10-24	3/8"	100 Pcs.	NEW
18685PK	10-32	3/8"	100 Pcs.	NEW
18686PK	12-24	7/16"	100 Pcs.	NEW

**Disco** Automotive Hardware

Ph: 580-622-3090

Fax: 580-622-3781

discosales@discoautomotive.com

CNP102

# COOL NEW PRODUCTS

## Standard Fasteners

Screws Phillips Pan Head Sheet Metal Stainless Steel



Part #	Size	Qty.		Part #	Size	Qty.	
18723PK	6 x 1/2"	100 Pcs.	NEW	18741PK	10 x 1 1/2"	25 Pcs.	NEW
18724PK	6 x 3/4"	100 Pcs.	NEW	18742PK	10 x 1 3/4"	25 Pcs.	NEW
18725PK	6 x 1"	100 Pcs.	NEW	18743PK	10 x 2"	25 Pcs.	NEW
18726PK	6 x 1 1/4"	100 Pcs.	NEW	18744PK	12 x 1/2"	50 Pcs.	NEW
18727PK	6 x 1 1/2"	50 Pcs.	NEW	18745PK	12 x 3/4"	50 Pcs.	NEW
18728PK	6 x 1 3/4"	50 Pcs.	NEW	18746PK	12 x 1"	50 Pcs.	NEW
18729PK	6 x 2"	50 Pcs.	NEW	18747PK	12 x 1 1/4"	25 Pcs.	NEW
18730PK	8 x 1/2"	100 Pcs.	NEW	18748PK	12 x 1 1/2"	25 Pcs.	NEW
18731PK	8 x 3/4"	50 Pcs.	NEW	18749PK	12 x 1 3/4"	25 Pcs.	NEW
18732PK	8 x 1"	50 Pcs.	NEW	18750PK	12 x 2"	25 Pcs.	NEW
18733PK	8 x 1 1/4"	50 Pcs.	NEW	18751PK	12 x 3"	25 Pcs.	NEW
18734PK	8 x 1 1/2"	25 Pcs.	NEW	18752PK	14 x 1/2"	100 Pcs.	NEW
18735PK	8 x 1 3/4"	25 Pcs.	NEW	18753PK	14 x 3/4"	100 Pcs.	NEW
18736PK	8 x 2"	25 Pcs.	NEW	18754PK	14 x 1"	50 Pcs.	NEW
18737PK	10 x 1/2"	100 Pcs.	NEW	18755PK	14 x 1 1/4"	50 Pcs.	NEW
18738PK	10 x 3/4"	50 Pcs.	NEW	18756PK	14 x 1 1/2"	25 Pcs.	NEW
18739PK	10 x 1"	50 Pcs.	NEW	18757PK	14 x 1 3/4"	25 Pcs.	NEW
18740PK	10 x 1 1/4"	50 Pcs.	NEW				

## Subaru Clips & Fasteners

Retainers Push Type

**16149PK** 13/64" (5mm) Hole Size 15 Pcs.  
 8.50mm Stem Length  
 10mm Head Diameter  
 Black Nylon  
 Front & Rear Bumper  
 Push Type Retainers  
 Subaru # 909140059



## Hyundai Clips & Fasteners

Retainers Push Type

**16409PK** 5/16" (8mm) Hole Size 25 Pcs.  
 11mm Stem Length  
 18mm Head Diameter  
 Black Nylon Bumper Cover  
 Push Type Retainers  
 Hyundai # 86590-1W000



*Disco* Automotive Hardware

Ph: 580-622-3090

Fax: 580-622-3781



discosales@discoautomotive.com



CNP103

# COOL NEW PRODUCTS

## Chrysler Clips & Fasteners

### Retainers Moulding

<b>16457PK</b>	5/16" (8mm) Hole Size 14mm Stem Length 12.50mm Top Head Size Yellow Nylon Interior Trim Retainers Chrysler # 68085677AA	<b>25 Pcs.</b>		
----------------	----------------------------------------------------------------------------------------------------------------------------------------	----------------	------------------------------------------------------------------------------------	-------------------------------------------------------------------------------------



<b>16094PK</b>	23/64" (9mm) Hole Size 10mm Stem Length 8mm x 10mm Top Head Size White Nylon Body Side Moulding Clips Chrysler # 68241251AA	<b>10 Pcs.</b>		
----------------	--------------------------------------------------------------------------------------------------------------------------------------------	----------------	------------------------------------------------------------------------------------	-------------------------------------------------------------------------------------

## G.M. Clips & Fasteners



### Rivets Automotive

<b>13416PK</b>	5/32" (4mm) Rivet Diameter 9/32" Flange Diameter 11/64-11/32" Grip Range Aluminum Rivet Stainless Steel Mandrel G.M. # 92139150	<b>25 Pcs.</b>		
----------------	------------------------------------------------------------------------------------------------------------------------------------------------	----------------	-------------------------------------------------------------------------------------	--



### Retainers Weatherstrip

<b>16451PK</b>	13/64" (5mm) Hole Size 8mm Stem Length 6.50 x 14mm Head Size Natural Nylon Weatherstrip Retainers G.M. # 11611342	<b>100 Pcs.</b>		
----------------	----------------------------------------------------------------------------------------------------------------------------------	-----------------	--------------------------------------------------------------------------------------	---------------------------------------------------------------------------------------

### Retainers Headliner

<b>16398PK</b>	1/4" (6.50mm) Hole Size 21mm Stem Length 25mm Head Diameter Black Nylon Headliner Retainers G.M. # 13475541	<b>25 Pcs.</b>		
----------------	----------------------------------------------------------------------------------------------------------------------------	----------------	--------------------------------------------------------------------------------------	---------------------------------------------------------------------------------------

### Retainers Trim Panel

<b>16452PK</b>	8 x 25.40mm Hole Size 15.50mm High 16.50 x 26.50mm Hd Zinc with Blue Topcoat Radiator Grill & Quarter Trim Panel Retainers G.M. # 11519069	<b>15 Pcs.</b>		
----------------	-----------------------------------------------------------------------------------------------------------------------------------------------------------	----------------	--------------------------------------------------------------------------------------	---------------------------------------------------------------------------------------

*Disco* Automotive Hardware

Ph: 580-622-3090

Fax: 580-622-3781

discosales@discoautomotive.com

CNP104



# COOL NEW PRODUCTS

## Bristle Abrasive Discs

### Green Bristle Discs

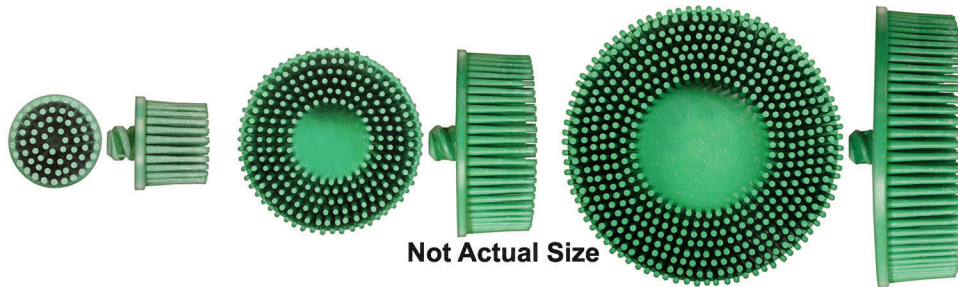

Not Actual Size

These Bristle Discs have abrasive grains embedded in the Bristles, the plastic breaks down exposing new abrasive as you use them, which makes them a great option for surface preparation, and removing gasket materials.

Part #	Size	Grit	Max RPM	"R" Holder	Qty.	
18760PK	1"	50 Grit	30,000	18769	1 Pc.	NEW
18760B	1"	50 Grit	30,000	18769	10 Pcs.	NEW
18761PK	2"	50 Grit	25,000	18770	1 Pc.	NEW
18761B	2"	50 Grit	25,000	18770	10 Pcs.	NEW
18762PK	3"	50 Grit	15,000	18771	1 Pc.	NEW
18762B	3"	50 Grit	15,000	18771	10 Pcs.	NEW

### Yellow Bristle Discs

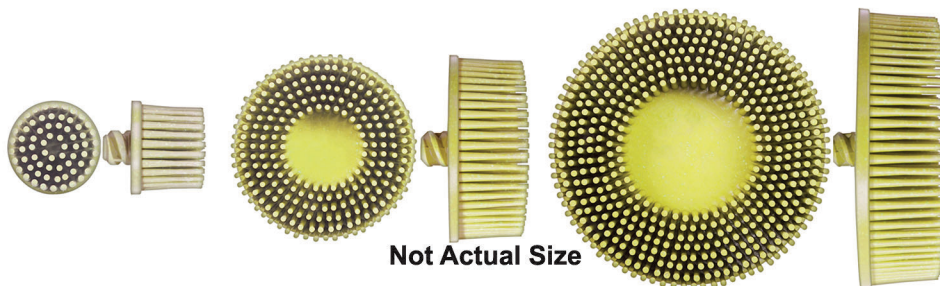

Not Actual Size

These Bristle Discs have abrasive grains embedded in the Bristles, the plastic breaks down exposing new abrasive as you use them, which makes them a great option for surface preparation, and removing gasket materials.

Part #	Size	Grit	Max RPM	"R" Holder	Qty.	
18763PK	1"	80 Grit	30,000	18769	1 Pc.	NEW
18763B	1"	80 Grit	30,000	18769	10 Pcs.	NEW
18764PK	2"	80 Grit	25,000	18770	1 Pc.	NEW
18764B	2"	80 Grit	25,000	18770	10 Pcs.	NEW
18765PK	3"	80 Grit	15,000	18771	1 Pc.	NEW
18765B	3"	80 Grit	15,000	18771	10 Pcs.	NEW

**Disco** Automotive Hardware

Ph: 580-622-3090

Fax: 580-622-3781

discosales@discoautomotive.com

CNP105

# COOL NEW PRODUCTS

## Bristle Abrasive Discs

### Grey Bristle Discs

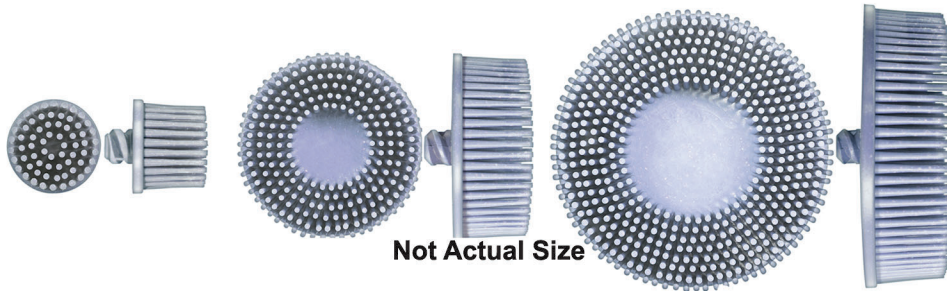

Not Actual Size

These Bristle Discs have abrasive grains embedded in the Bristles, the plastic breaks down exposing new abrasive as you use them, which makes them a great option for surface preparation, and removing gasket materials.

Part #	Size	Grit	Max RPM	"R" Holder	Qty.	
18766PK	1"	120 Grit	30,000	18769	1 Pc.	NEW
18766B	1"	120 Grit	30,000	18769	10 Pcs.	NEW
18767PK	2"	120 Grit	25,000	18770	1 Pc.	NEW
18767B	2"	120 Grit	25,000	18770	10 Pcs.	NEW
18768PK	3"	120 Grit	15,000	18771	1 Pc.	NEW
18768B	3"	120 Grit	15,000	18771	10 Pcs.	NEW

### Bristle Disc "R" Holders



Part #	Size	Max RPM	Qty.	
18769	1"	30,000	1 Pc.	NEW
18770	2"	25,000	1 Pc.	NEW
18771	3"	15,000	1 Pc.	NEW

*Disco* Automotive Hardware

Ph: 580-622-3090

Fax: 580-622-3781

discosales@discoautomotive.com

CNP106

# COOL NEW PRODUCTS

## Tesla Clips & Fasteners

### Nuts Push On Type Non-Threaded Stud Metric

**17064PK**

6mm Stud Size  
18mm Flange  
5mm Overall Height  
Black Nylon  
Engine Cover &  
Wheel Apron Push Nuts  
Tesla # 1110713-99-C

50 Pcs.

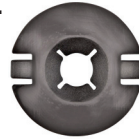

### Rivets Automotive Pop

**18298PK**

3/16" (4.76mm) Diameter  
3/8" Flange Size  
1/16 - 17/64" Grip Range  
All Aluminum  
High Strength Rivets  
Tesla # 1028719-00-A

25 Pcs.



### Retainers Push Type

**18299PK**

5/16" (8mm) Hole Size  
16mm Stem Length  
18mm Flange Diameter  
5 - 7mm Panel Range  
Black Nylon  
Push Type Retainers  
Tesla # 1128034-00-B

25 Pcs.

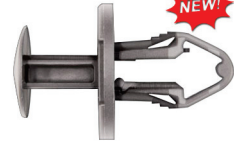

### Retainers Trim Panel

**17092PK**

25/64" (10.50mm) Hole Size  
16.50mm Stem Length  
15mm Top Head Size  
White Nylon  
Headliner Retainers  
Tesla # 1142766-00-AA

25 Pcs.



### Clips Moulding

**17087PK**

10mm Width  
11.30mm Length  
Yellow Zinc Finish  
Radiator Cover & Interior  
Trim Panel Retainers  
Tesla # 1115346-00-A

50 Pcs.



**17088PK**

11mm Width  
16mm Length  
3.50mm "U" Width  
Zinc Finish  
Rocker & Trim Panel Retainers  
Tesla # 1011978-00-A

50 Pcs.



**Disco** Automotive Hardware

Ph: 580-622-3090

Fax: 580-622-3781

discosales@discoautomotive.com

CNP107

# COOL NEW PRODUCTS

## Mercedes Clips & Fasteners

### Hex Head Trim Screw

**18277PK**

4.8-1.61 x 20mm  
8mm Hex Head Sems  
26mm Outside Diameter Loose Washer  
Black Finish  
Trim Screws  
Mercedes # 201-990-05-36

**25 Pcs.**



### Retainers Moulding

**16357PK**

3/8" (9.50mm) Hole Size  
12mm Stem Length  
20 x 30mm Head Size  
Black & Gray With Sealer  
Moulding Retainers  
Mercedes # 012-988-50-78

**25 Pcs.**



## Nissan Clips & Fasteners

### Retainers Weatherstrip

**16063PK**

13/64" (5mm) Hole Size  
8.30mm Stem Length  
5 x 15mm Top Head Size  
Natural Nylon  
Door Weatherstrip Retainers  
Nissan # 80850-1FA0B

**50 Pcs.**



### Insulation Retainer

**18302PK**

15/64" (6mm) Hole Size  
10mm Stem Length  
30mm Head Diameter  
Black Nylon  
Hood Insulation Retainers  
Nissan # F5846-30F00

**25 Pcs.**



## Subaru Clips & Fasteners

### Retainers Moulding

**9207PK**

23/64" (9mm) Hole Size  
12mm Stem Length  
11 x 14mm Top Head Size  
Black Nylon Fender, Rocker,  
Garnish Trim Retainers  
Subaru # 909130088

**25 Pcs.**



*Disco* Automotive Hardware

Ph: 580-622-3090

Fax: 580-622-3781

discosales@discoautomotive.com

CNP 108

# COOL NEW PRODUCTS

## Assortments

### Assortment Retainers, Push Type



5mm to 10mm Hole Size  
Black Nylon Retainers  
24 Hole Gray Plastic Tray  
290 Total Pieces  
Contains 24 Different Sizes  
Push Type Retainer Assortment

BACK OF TRAY					
# 8613G Universal Push Type Retainer Assortment					
10686PK 13/64" (5mm) Hole Size 12mm Stem Length 16mm Flange Diameter Black Nylon Front Fascia Retainers	9067PK 1/4" (6.35mm) Hole Size 26/32" Stem Length 11 1/4" Flange Diameter Black Nylon Radiator Shroud Phillips Screw Retainers	1603PK 9/32" (7mm) Hole Size 12mm Stem Length 15mm Flange Diameter Black Nylon Phillips Screw Retainers	9287PK 5/16" (8mm) Hole Size 12mm Stem Length 15mm Flange Diameter Black Nylon Phillips Screw Retainers	9202PK 25/64" (10mm) Hole Size 12mm Stem Length 20mm Flange Diameter Black Nylon Front & Rear Bumper Phillips Screw Retainers	12888PK 25/64" (10mm) Hole Size 14mm Stem Length 20mm Flange Diameter Black Nylon Bumper Push Type Retainers
9617PK 15/64" (6mm) Hole Size 16mm Stem Length 17mm Flange Diameter Black Nylon Radiator & Fender Push Type Retainers	9559PK 1/4" (6.35mm) Hole Size 3/4" Stem Length 19/32" Flange Diameter Black Nylon Wheel Moulding Push Type Retainers	9465PK 9/32" (7mm) Hole Size 15mm Stem Length 20mm Flange Diameter Black Nylon Front Fender Liner Push Type Retainers	10569PK 9/32" (7mm) Hole Size 15mm Stem Length 20mm Flange Diameter Black Nylon Engine Under Cover Push Type Retainers	9292PK 5/16" (8mm) Hole Size 10mm Stem Length 20mm Flange Diameter Black Nylon Front Fender Push Type Retainers	9294PK 25/64" (10mm) Hole Size 15mm Stem Length 18mm Flange Diameter Black Nylon Push Type Retainers
2128PK 5/16" (8mm) Hole Size 15mm Stem Length 20mm Flange Diameter Black Nylon Fender & Bumper Push Type Retainers	11019PK 5/16" (8mm) Hole Size 12mm Stem Length 20mm Flange Diameter Black Nylon Cow, Bumper & Fender Liner Push Type Retainers	9540PK 5/16" (8mm) Hole Size 15mm Stem Length 20mm Flange Diameter Black Nylon Push Type Retainers	13091PK 5/16" (8mm) Hole Size 15mm Stem Length 20mm Flange Diameter Black Nylon Fender Liner Push Type Retainers	1860PK 5/16" (8mm) Hole Size 20mm Stem Length 20mm Flange Diameter Black Nylon Air Baffle Push Type Retainers	9282PK 25/64" (10mm) Hole Size 15mm Stem Length 20mm Flange Diameter Black Nylon Front & Rear Front Bumper Push Type Retainers
1861PK 5/16" (8mm) Hole Size 20mm Stem Length 15mm Flange Diameter Black Nylon Rocker Panel Retainers	2133PK 5/16" (8mm) Hole Size 15mm Stem Length 18mm Flange Diameter Black Nylon Push Type Retainers	9943K 23/64" (8mm) Hole Size 15mm Stem Length 18mm Flange Diameter Black Nylon Fender & Bumper Push Type Retainers	9327PK 23/64" (8mm) Hole Size 15mm Stem Length 18mm Flange Diameter Black Nylon Rear Bumper Cover Push Type Retainers	10628PK 23/64" (8mm) Hole Size 15mm Stem Length 18mm Flange Diameter Black Nylon Bumper Cover & Grille Push Type Retainers	9382PK 25/64" (10mm) Hole Size 18mm Stem Length 20mm Flange Diameter Black Nylon Front & Rear Bumper Push Type Retainers
FRONT OF TRAY					

Part #	Tray	Material	Tray #	Tray Color	Lid Color	Label	Clear Pocket	Qty.
8613G	24 Holes	Plastic	80123	Gray	Gray	Paper	Yes	1 Pc.
8613BC	24 Holes	Plastic	80155BC	Dark Blue	Clear	Paper	Yes	1 Pc.
8613GC	24 Holes	Plastic	80123GC	Gray	Clear	Paper	Yes	1 Pc.
8613RC	24 Holes	Plastic	80152RC	Red	Clear	Paper	Yes	1 Pc.
8613YC	24 Holes	Plastic	80123YC	Yellow	Clear	Paper	Yes	1 Pc.



8613

8613BCP

8613GCP

8613RCP

8613YCP

BACK OF TRAY					
# 8613 Universal Push Type Retainer Assortment					
5675PK 1/4" (6.40mm) Hole Size Black Nylon Push Type Retainer	5935PK 1/4" (6.40mm) Hole Size Black Nylon Push Type Retainer	5676PK 5/16" (8mm) Hole Size Black Nylon Radiator Push Type Retainer	1861PK 5/16" (8mm) Hole Size Black Nylon Push Type Retainer	5672PK 3/8" (9.50mm) Hole Size Black Nylon Fascia Blind Rivets	
5940PK 5/16" (8mm) Hole Size Black Nylon Push Type Retainer	2128PK 5/16" (8mm) Hole Size Black Nylon Push Type Retainer	9282PK 5/16" (8mm) Hole Size Black Nylon Push Type Retainer	1976PK 5/16" (8mm) Hole Size Black Nylon Bumper Push Type Retainers	5672PK 12" (12.70mm) Hole Size Black Nylon Fascia Push Type Retainers	
5930PK 15/64" (6mm) Hole Size Black Nylon Phillips Sc	9067PK 1/4" (6.35mm) Hole Size Black Nylon Push Type Retainer	9202PK 9/32" (7mm) Hole Size Black Nylon Phillips Screw Retainer	1976PK 5/16" (8mm) Hole Size Black Nylon Phillips Screw Retainers	1976PK 5/16" (8mm) Hole Size Black Nylon Phillips Screw Retainers	D-123PK 25/64" (10mm) Hole Size Black Nylon Phillips Screw Retainers
5901PK 15/64" (6mm) Hole Size Black Nylon Phillips Sc	5895K 5/16" (8mm) Hole Size Black Nylon Phillips Screw Retainer	9202PK 9/32" (7mm) Hole Size Black Nylon Phillips Screw Retainer	9202PK 5/16" (8mm) Hole Size Black Nylon Phillips Screw Retainers	9202PK 5/16" (8mm) Hole Size Black Nylon Phillips Screw Retainers	D-124PK 25/64" (10mm) Hole Size Black Nylon Phillips Screw Retainers
FRONT OF TRAY					

**RETIRED**

For latest configuration see New Catalog Sections on our website.

*Disco* Automotive Hardware

Ph: 580-622-3090

Fax: 580-622-3781

discosales@discoautomotive.com

CNP109