

# Imports

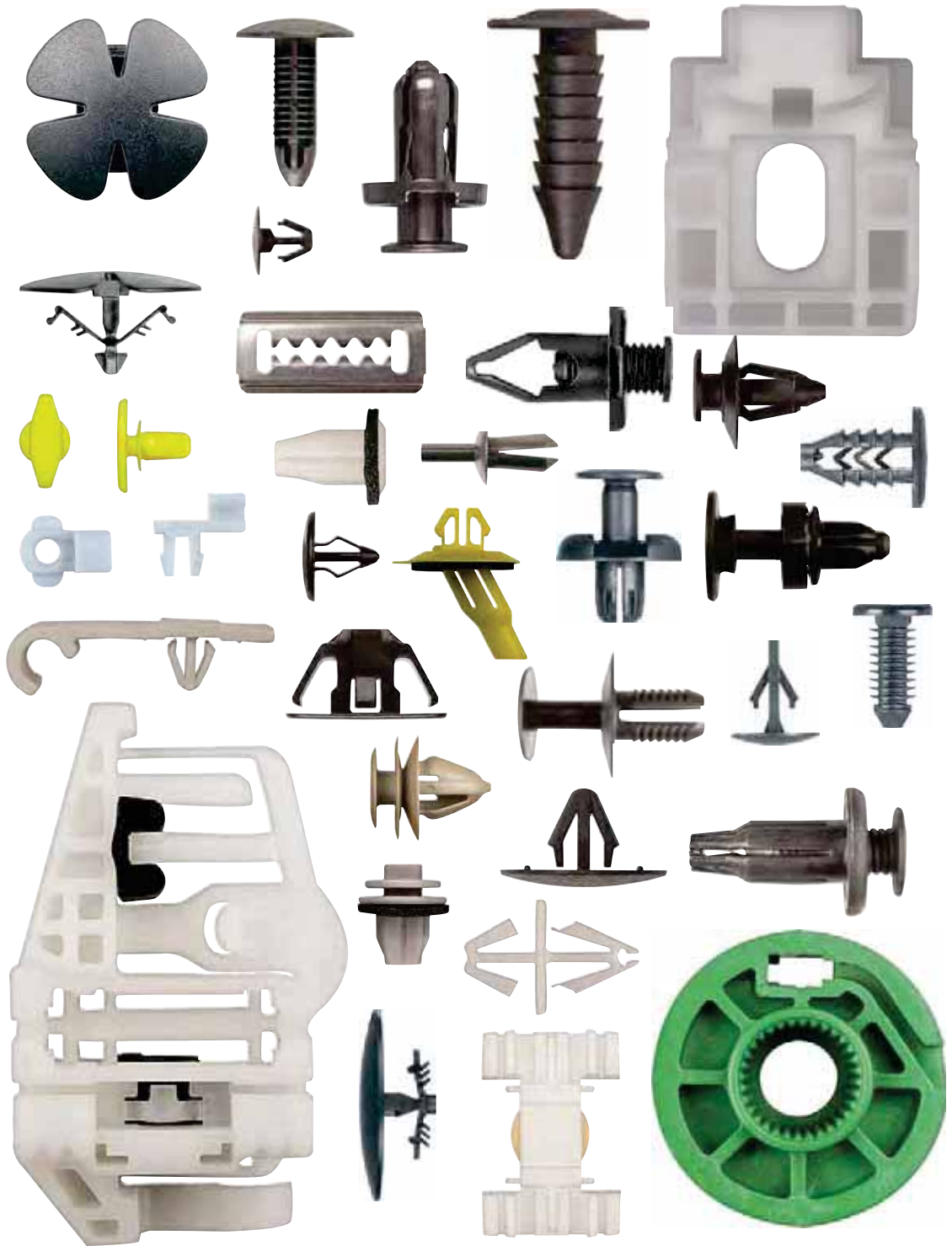

# Isuzu

## Retainers Door Trim Panel

**9081PK** 23/64" (9mm) Hole Size  
 14mm Stem Length  
 13mm Top Head Diameter  
 Natural Nylon  
 Door Trim Panel Retainers  
 G.M. # 94226492  
 Isuzu # 8-94226-492-0  
 Mazda # 9927-40-825  
 Toyota # 67771-12010F, 67771-01010

25 Pcs.



## Reainers Grille

**9082PK** 13mm Width  
 22mm Overall Length  
 Black Plastic  
 Grille Headlight Clips  
 G.M. # 94218027, H200-50-715  
 Isuzu # 8942180270, 58974-00008  
 Mazda # B092-50-715, BF67-S0715  
 Mitsubishi # MB153825  
 Toyota # 90467-13011, 90467-12020

25 Pcs.



# Jaguar

## Retainers Phillips Screw

**9580PK** 15/32" (12mm) Hole Size  
 12mm Stem Length  
 24mm Flange Diameter  
 Black Nylon Radiator Support &  
 Air Deflector Retainers  
 Jaguar # XR831159

10 Pcs.



## Retainers Headliner

**10387PK** 14.50mm Width  
 39.30mm Length  
 Black Nylon  
 Headliner Retainers  
 Jaguar # C2Z11575

15 Pcs.



**10386PK** 16mm Width  
 51mm Length  
 Black Nylon  
 Headliner Retainers  
 Jaguar # C2Z11576

15 Pcs.





# Kia





## Nuts Nylon

<b>12062PK</b>	11mm Head Size 9mm Stem Length 8mm Hole Size White Nylon Front & Rear Bumper Cover Nuts Kia # 86699-2D000	<b>25 Pcs.</b>		
<b>10781PK</b>	15mm Head Diameter 8mm Stem Length 10mm Hole Size Natural Nylon Headlight Assembly Grommets Hyundai # XG300/350 Kia # 92351-37000	<b>25 Pcs.</b>		
<b>12056PK</b>	14mm Hex Size 14mm Overall Height 25mm Flange Diameter Black Nylon Cowl Trim Retainers Kia # 0K95A-68615	<b>25 Pcs.</b>		





## Retainers Grommet

<b>12075PK</b>	25.00 x 30.00mm Head Size 15mm Stem Length 35mm Overall Length Black Nylon With Sealer Bumper Cover Grommets Kia # 86591-25000	<b>5 Pcs.</b>		
----------------	---	---------------	---	--

## Retainers Phillips Screw

<b>12377PK</b>	5/16" (8mm) Hole Size 12mm Stem Length 18mm Flange Diameter Black Nylon Grille Phillips Screw Retainers Kia # 0G032-50037-A	<b>15 Pcs.</b>		
<b>5900PK</b>	5/16" (8mm) Hole Size 18mm Stem Length 20mm Flange Size Black Nylon Inner Fender Phillips Screw Retainers Ford # NA01-56145 Kia # MNA01-56-145 Nissan # 63844-01A00	<b>25 Pcs.</b>		

## Retainers Moulding

<b>15873PK</b>	5/16" (8mm) Hole Size 12mm Stem Length 13mm Top Head Diameter Gray Nylon Exterior & Interior Moulding Retainers Kia # 0K95-A-68401	<b>50 Pcs.</b>		
<b>15978PK</b>	7/16" (11mm) Hole Size 12mm Stem Length 10.00 x 12.00mm Top Head Size Gray Nylon With Sealer Liftgate Moulding Clips Kia # 87382-2W000	<b>25 Pcs.</b>		





# Kia

## Retainers Moulding







<b>12602PK</b>	15/32" (12mm) Hole Size 10mm Stem Length 10.50 x 9.50mm Top Head Size White Nylon With Sealer Moulding Retainers Kia # 87758-3E000, 87759-3E000, 87719-02500	<b>25 Pcs.</b>		
<b>17914PK</b>	15/32" (12mm) Hole Size 10mm Stem Length 10.00 x 12.00mm Top Head Size Red Nylon With Sealer Fender, Rocker & Wheel Moulding Retainers Kia # 87756-C5000	<b>25 Pcs.</b>		
<b>14954PK</b>	15/32" (12mm) Hole Size 10mm Stem Length 11.00 x 13.00mm Top Head Size Red Nylon With Sealer Wheel Flare & Body Side Moulding Retainers Kia # 87756-3E500	<b>15 Pcs.</b>		

# Land Rover

## Retainers Door Trim Panel

<b>9682PK</b>	5/16" (8mm) Hole Size 11mm Stem Length 14mm Top Head Diameter White Nylon With Sealer Pillar Retainers Land Rover # LR034389, LR053837	<b>15 Pcs.</b>		
<b>16375PK</b>	5/16" (8mm) Hole Size 15mm Stem Length 14.50mm Top Head Diameter White Nylon With Sealer Trim Panel, Tailgate & Luggage Compartment Retainers Land Rover # LR013135	<b>15 Pcs.</b>		







## Retainers Moulding

<b>16461PK</b>	15/64" (6mm) Hole Size 13mm Stem Length 13mm Head Diameter Black Nylon Pillar, Rocker & Floor Moulding Push Type Retainers Land Rover # LR033144	<b>15 Pcs.</b>		
<b>10441PK</b>	5/16" (8mm) Hole Size 8mm Stem Length 12.50mm Top Head Diameter White & Yellow Nylon Moulding Retainers Land Rover # DYC101420	<b>25 Pcs.</b>		
<b>16460PK</b>	23/64" (9mm) Hole Size 15mm Stem Length 15.50mm Head Diameter Black Nylon Pillar Post Moulding Retainers Land Rover # LR002229	<b>25 Pcs.</b>		



22

# Lexus



## Nuts Nylon

<b>12634PK</b>	#4 (2.90mm) Screw Size 14mm Stem Length 9mm Head Size 7mm Hole Size Natural Nylon Side Moulding Screw Grommets Lexus # 90189-04207	<b>25 Pcs.</b>		
<b>10808PK</b>	#6 (3.50mm) Screw Size 7mm Stem Length 12.00 x 18.00mm Head Size 6.00 x 14.00mm Hole Size White Nylon Rocker Trim Screw Grommets Lexus # 90189-04059	<b>25 Pcs.</b>		
<b>9481PK</b>	#12 (5.50mm) Screw Size 24mm Stem Length 22.00 x 18.00mm Head Size White Nylon With Sealer Front Bumper Screw Grommets Lexus # 52197-30040	<b>15 Pcs.</b>		

## Clips Retaining

<b>15033PK</b>	5/16" (8mm) Hole Size 14mm Stem Length 8.00 x 17.00mm Head Size Black Nylon Retaining Clips Lexus # 90467-06092	<b>10 Pcs.</b>		
----------------	--	----------------	---	---

## Retainers Push Type

<b>9329PK</b>	9/32" (7mm) Hole Size 9mm Stem Length 17mm Flange Diameter Black Nylon Push Type Retainers Lexus # 90467-07117	<b>10 Pcs.</b>		
---------------	---	----------------	---	---

## Retainers Phillips Screw

<b>2143PK</b>	9/32" (7mm) Hole Size 12mm Stem Length 20mm Flange Diameter Black Nylon Phillips Screw Retainers Lexus # 90467-07138, 90467-07138-C0	<b>10 Pcs.</b>		
<b>1943PK</b>	23/64" (9mm) Hole Size 23mm Stem Length 18mm Flange Diameter Black Nylon Bumper Cover Phillips Screw Retainers Lexus # 90467-09101	<b>25 Pcs.</b>		
<b>10428PK</b>	23/64" (9mm) Hole Size 26mm Stem Length 19mm Flange Diameter Black Nylon Phillips Screw Retainers Lexus # 90467-09143	<b>10 Pcs.</b>		
<b>5895PK</b>	23/64" (9mm) Hole Size 27mm Stem Length 15mm Flange Diameter Black Nylon Bumper Cover Phillips Screw Retainers Lexus # 90467-09093	<b>10 Pcs.</b>		



# Lexus

## Retainers Slotted Screw







<b>11950PK</b>	10mm Head Diameter 24mm Stem Length Black Nylon Front Bumper Cover & Fender Liner Pins Use With # 11951 & 17611 Lexus # 47749-50090 Toyota # 53879-30040	<b>15 Pcs.</b>		
<b>11951PK</b>	35mm Width 25mm Length Black Nylon Front Bumper Cover & Fender Liner Retainers Use With # 11950 Lexus # 53879-50020	<b>10 Pcs.</b>		
<b>17611PK</b>	32mm Width 39mm Length Black Nylon Front Bumper Cover Cover Retainers Use With Disco # 11950 Toyota # 53879-30040	<b>5 Pcs.</b>		

## Retainers Moulding

<b>10396PK</b>	5/16" (8mm) Hole Size 20mm Stem Length 18mm Head Diameter Gray Nylon With Sealer Fender Moulding Retainers Lexus # 75492-60030	<b>10 Pcs.</b>		
<b>10397PK</b>	5/16" (8mm) Hole Size 20mm Stem Length 18mm Head Diameter Yellow Nylon With Sealer Fender Moulding Retainers Lexus # 75394-60060	<b>10 Pcs.</b>		
<b>10493PK</b>	23/64" (9mm) Hole Size 9mm Stem Length 18mm Head Diameter Pink Nylon With Sealer Moulding Retainers Lexus # 75395-33030	<b>15 Pcs.</b>		
<b>10491PK</b>	25/64" (10mm) Hole Size 10mm Stem Length 18mm Head Diameter Gray Nylon Rocker Panel Moulding Retainers Lexus # 75392-60030, 75392-60031	<b>15 Pcs.</b>		
<b>13373PK</b>	7/16" (11mm) Hole Size 10mm Stem Length 20mm Flange Diameter Green Nylon With Sealer Rear Lamp Moulding Retainers Lexus # 81496-50010	<b>15 Pcs.</b>		

# Lexus

## Retainers Moulding



<b>11853PK</b>	18mm Head Diameter 24.50mm Overall Length Black Nylon Moulding Retainers Lexus # 75393-60030	<b>15 Pcs.</b>		
<b>9330PK</b>	5/16" (8mm) Hole Size 15mm Stem Length 24.70 x 30.30mm Head Size Black Nylon Side Moulding Retainers Lexus # 75049-33010	<b>5 Pcs.</b>		
<b>9359PK</b>	15mm Overall Width 55mm Overall Length Blue Nylon Windshield Moulding Retainers Lexus # 75545-53011	<b>5 Pcs.</b>		

# Mazda

## Nuts Nylon "U" Type Metric

<b>1601PK</b>	#10 (4.80mm) Screw Size Up to 1.00mm Panel Range 11mm Center of Hole to Edge Black Nylon Fender Wheel Housing "U" Type Nuts G.M. # 94841226 Mazda LA01-56-135 Toyota # 53879-14010-A, 53879-14020, 53879-22030	<b>15 Pcs.</b>		
<b>15214PK</b>	#10 (4.80mm) Screw Size Up to 1.00mm Panel Range 11mm Center of Hole to Edge Gray Nylon "U" Type Nuts Mazda # B455-56-135	<b>25 Pcs.</b>		
<b>18105PK</b>	#10 (4.80mm) Screw Size Up to 1.00mm Panel Range 11mm Center of Hole to Edge Gray Nylon Front Bumper "U" Type Nuts Mazda # C274-50-133	<b>25 Pcs.</b>		











## Nuts Nylon

<b>1577PK</b>	#8 (4.20mm) Screw Size 6.50mm Stem Length 10mm Head Diameter 6mm Hole Size Natural Nylon Side Marker Light Screw Grommets Honda # 75522-611-000, 75522-611-0000 Mazda # 9991-00-412 Mitsubishi # MS-480001 Nissan # 96706-B0700, 97606-B0700 Toyota # 90189-04042, 95900-04036	<b>50 Pcs.</b>		
---------------	--	----------------	---	---



22

# Mazda

## Nuts Nylon

<b>9659PK</b>	#8 (4.20mm) Screw Size 15mm Stem Length 20mm Head Diameter White Nylon Screw Grommets Mazda # GJ6A-58-975	<b>10 Pcs.</b>		
<b>1572PK</b>	#8 (4.20mm) Screw Size 17mm Stem Length 16mm Head Diameter 8mm Hole Size Natural Nylon Screw Grommets Honda # 90661-SC7-0030, 90661-SC7-003 Mazda # H001-50-841, Mitsubishi # MS-480012 Nissan # 01651-00481, 74798-S90000, 01281-00231 Toyota # 90189-06042	<b>25 Pcs.</b>		
<b>1614PK</b>	#10 (4.80mm) Screw Size 8mm Stem Length 13mm Head Size 8.50mm Hole Size Natural Nylon Screw Grommets Honda # 75521-611-0000, 91619-SA5-003 Mazda # 9991-00-601 Nissan # 96706-P0105 Toyota # 90189-06010	<b>25 Pcs.</b>		
<b>1296PK</b>	#10 (4.80mm) Screw Size 8mm Stem Length 16.50mm Head Diameter 8.00 x 8.50mm Hole Size Natural Nylon Screw Grommets Honda # 90662-671-0030, 90662-671-003, 90662-SB-003 Mazda # 9991-00-503 Nissan # 68425-H5000, 62698-V7000	<b>25 Pcs.</b>		
<b>14992PK</b>	#10 (4.80mm) Screw Size 7.50mm Stem Length 11.50mm Head Diameter 8.00 x 8.00mm Hole Size Natural Nylon Spalsh Shield Grommets Mazda # 9991-00-501	<b>25 Pcs.</b>		

## Nuts Specialty

<b>16380PK</b>	2.50mm Stud Size 8mm Head Diameter 6mm Hole Size Clear Nylon With Sealer Emblem Tubular Nuts Mazda # LA01-51-958	<b>25 Pcs.</b>		
<b>16383PK</b>	3.50mm Stud Size 12mm Outside Diameter Stainless Steel Emblem Push Nuts Mazda # 9957-83-000	<b>50 Pcs.</b>		

## Clips Routing Cable & Tube

<b>9820PK</b>	15/64" (6mm) Hole Size 8mm Tubing or Cable Diameter Natural Nylon Tube/Cable Routing Clips Mazda # 9927-70901	<b>25 Pcs.</b>		
---------------	---	----------------	--	---



# Mazda

## Clips Routing Cable & Tube

**18108PK** 15/64" (6mm) Hole Size  
9mm Stem Length  
Holds 5mm Diameter Cable  
Black Nylon  
Hood Release Cable Clips  
Mazda # D001-56-731

25 Pcs.



## Clips Hood Release Cable

**16379PK** 8mm Rod Size  
9.00 x 12.00mm Hole Size  
26mm Overall Length  
Black Nylon  
Hood Prop Rod Clips  
Mazda # L206-56-652A

25 Pcs.



## Retainers Hood Insulation

**13315PK** 15/64" (6mm) Hole Size  
9mm Stem Length  
20mm Head Diameter  
Black Nylon  
Hood Insulation Retainers  
Ford # F22Z-16774-A, GA2A-56694  
Mazda # G030-68-885-B-38

25 Pcs.



**9522PK** 15/64" (6mm) Hole Size  
10mm Stem Length  
14mm Head Diameter  
Black Nylon  
Hood Insulation Retainers  
Ford # F1CZ-16774-A  
Mazda # B455-56-741

25 Pcs.



**13347PK** 9/32" (7mm) Hole Size  
10mm Stem Length  
20mm Head Diameter  
Black Nylon  
Hood Insulation Retainers  
Mazda # TD11-56-694

25 Pcs.



22

## Retainers Weatherstrip

**12509PK** 5/32" (4mm) Hole Size  
7mm Stem Length  
9mm Head Diameter  
Black Nylon  
Weatherstrip Retaining Clips  
Mazda # BP4K-58-762

25 Pcs.



**16339PK** 13/64" (5mm) Hole Size  
10mm Stem Length  
5.00 x 11.00mm Head Size  
White Nylon  
Weatherstrip Retainers  
Mazda # KD45-58-762

25 Pcs.





**12069PK** 13/64" (5mm) Hole Size  
10mm Stem Length  
5.00 x 15.00mm Head Size  
Natural Nylon  
Weatherstrip Retainers  
Ford # E7GZ-6120586-B  
Hyundai # 86438-2B000  
Mazda # G031-58-762  
Toyota # 67867-89103, 97868-89101,  
67867-28030

50 Pcs.







# Mazda

## Retainers Weatherstrip



<b>15145PK</b>	13/64" (5mm) Hole Size 10mm Stem Length 14mm Head Diameter Black Nylon Weatherstrip Retainers Mazda # J001-56-741	<b>25 Pcs.</b>		
----------------	--	----------------	--	---

## Clips Retaining

<b>9886PK</b>	7/32" (5.50mm) Hole Size 15mm Stem Length 11mm Head Diameter 5mm Panel Thickness Black Nylon Retaining Clips Mazda # 9926-40-543A Nissan # 01553-00291	<b>50 Pcs.</b>		
---------------	---	----------------	--	---

<b>1634PK</b>	15/64" (6mm) Hole Size 16mm Stem Length 14mm Head Diameter 5mm Panel Thickness Black Nylon Retaining Clips Honda # 90467-11005 Isuzu # 89421-76980 Mazda # 9926-40-658 Nissan # 76906-T3000, 76916-T3000	<b>50 Pcs.</b>		
---------------	---	----------------	--	---



<b>10414PK</b>	5/16" (8mm) Hole Size 15mm Stem Length 15mm Head Diameter Black Nylon Retaining Clips Mazda # B001-68-302-00 Toyota # 90950-01248	<b>25 Pcs.</b>		
----------------	---	----------------	--	---



<b>10407PK</b>	5/16" (8mm) Hole Size 18mm Stem Length 18mm Head Diameter Black Nylon Retaining Clips Mazda # 8133-50-022	<b>25 Pcs.</b>		
----------------	--	----------------	--	---

## Retainers Push Type

<b>12546PK</b>	15/64" (6mm) Hole Size 12mm Stem Length 18mm Flange Diameter Gray Nylon Push Type Retainers Mazda # GJ21-68885-B69	<b>25 Pcs.</b>		
----------------	---	----------------	--	---

<b>15853PK</b>	15/64" (6mm) Hole Size 16mm Stem Length 14mm Head Diameter Black Nylon Interior Trim Push Type Retainers Mazda # B101-68-252-00	<b>25 Pcs.</b>		 <b>NEW!</b>
----------------	---	----------------	--	---









<b>16341PK</b>	15/64" (6mm) Hole Size 14mm Stem Length 18mm Head Diameter Black Nylon Rear Trunk Liner Push Type Retainers Mazda # B467-68-AC3-02	<b>25 Pcs.</b>		 <b>NEW!</b>
----------------	--	----------------	--	---

<b>15951PK</b>	9/32" (7mm) Hole Size 11mm Stem Length 11mm Head Diameter Black Nylon Push Type Retainers Mazda # S51S-51-833	<b>15 Pcs.</b>		 <b>NEW!</b>
----------------	--	----------------	--	---









22

# Mazda

## Retainers Push Type

<b>11019PK</b>	5/16" (8mm) Hole Size 12mm Stem Length 20mm Flange Diameter Black Nylon Cowl, Bumper & Fender Liner Push Type Retainers Mazda # L33X13209 Nissan # 01553-05323, 01553-05933	<b>10 Pcs.</b>		
<b>18234PK</b>	5/16" (8mm) Hole Size 13mm Stem Length 20mm Flange Diameter Black Nylon Bumper, Push Type Retainers Engine Cover, Fender & Quarter Panel Mazda # B45A-56-146A Toyota # 90118-WB048	<b>25 Pcs.</b>		
<b>18109PK</b>	5/16" (8mm) Hole Size 14mm Stem Length 20mm Head Diameter Black Nylon Bumper Cover & Fender Liner Push Type Retainers Mazda # BGV4-56-145	<b>25 Pcs.</b>		
<b>13238PK</b>	25/64" (10mm) Hole Size 15mm Stem Length 19.50mm Flange Diameter Black Nylon Push Type Retainers Mazda # GD7A-50-EA1	<b>10 Pcs.</b>		

## Retainers Phillips Screw

<b>13396PK</b>	13/64" (5mm) Hole Size 9mm Stem Length 8.50 x 12.00mm Head Size Black Nylon Cowl Vent Phillips Screw Retainers Ford # 3M8Z-1502316-A Mazda # GJ6W-50-715A	<b>15 Pcs.</b>		
<b>9108PK</b>	15/64" (6mm) Hole Size 9mm Stem Length 20mm Flange Diameter Black Nylon Phillips Screw Retainers Isuzu # 8942431900, 9841690750 Mazda # 1395-68-676 Nissan # 9926-50-635, 75775-41300, 23270-3895, 80915-29A66	<b>15 Pcs.</b>		
<b>2015PK</b>	9/32" (7mm) Hole Size 11mm Stem Length 14mm Flange Diameter Black Nylon Phillips Screw Retainers G.M. # 94198687 Honda # 90657-SA6-0030, 90657-SA6-003 Mazda # N304-13-356-A, N304-13-356B Subaru # 59130AA000 Toyota # 90467-07072, 90467-07072-22	<b>25 Pcs.</b>		
<b>1603PK</b>	9/32" (7mm) Hole Size 12mm Stem Length 15mm Flange Diameter Black Nylon Phillips Screw Retainers G.M. # 20426301 Mazda # 9926-50-625 Toyota # 90467-06017, 90467-06017-41, 90467-06017-C0	<b>15 Pcs.</b>		





# Mazda

## Retainers Phillips Screw











<b>5920PK</b>	5/16" (8mm) Hole Size 9mm Stem Length 20mm Flange Diameter Black Nylon Splash Shield Phillips Screw Retainers Honda # 90675-SB3-003, 90675-SB0-003 Mazda # FB01-56-964 Nissan # 63876-95596, 63876-D5596	<b>25 Pcs.</b>		
<b>10747PK</b>	5/16" (8mm) Hole Size 9mm Stem Length 20mm Flange Diameter Black Nylon Mud Guard Phillips Screw Retainers Mazda # BC1D-56-145	<b>15 Pcs.</b>		
<b>9287PK</b>	5/16" (8mm) Hole Size 12mm Stem Length 18mm Flange Diameter Black Nylon Phillips Screw Retainers Ford # MB-455-56143, W705845-S300 Hyundai # 86590-28000 Mazda # B092-51-833	<b>10 Pcs.</b>		
<b>13273PK</b>	5/16" (8mm) Hole Size 13mm Stem Length 13mm Flange Diameter Black Nylon Phillips Screw Retainers Mazda # G14S-50-EA1	<b>25 Pcs.</b>		
<b>16335PK</b>	5 x 20mm Screw 10mm Stem Length 18mm Flange 21/64" (8.50mm) Hole Size Phillips Truss Head Screw & Nylon Tail Lamp Grommets Mazda # GJ6A-51-14Y	<b>15 Pcs.</b>		
<b>9600PK</b>	25/64" (10mm) Hole Size 11mm Stem Length 20.00 x 30.00mm Head Size Nylon Phillips Screw Retainers Ford E7ZG-17A904-B Mazda BF67-50-033	<b>10 Pcs.</b>		
<b>1998PK</b>	25/64" (10mm) Hole Size 18mm Stem Length 20.00 x 30.00mm Flange Size Black Nylon Bumper Cover Phillips Screw Retainers Ford # E7GZ-17A904-G Mazda # BF82-50-233, MBF82-50-233 Nissan # 01553-01393	<b>10 Pcs.</b>		
<b>10043PK</b>	25/64" (10mm) Hole Size 20mm Stem Length 20.00 x 30.00mm Flange Size Black Nylon Bumper Cover Retainers Ford # E92Z-17C756-C Mazda # GJ21-50-034	<b>10 Pcs.</b>		

# Mazda





## Clips Door Rod End

<b>10223PK</b>	4.20mm Rod Size 7mm Hole Size Left Hand Side Blue Nylon Door Rod End Clips Mazda # 9927-80-404	<b>25 Pcs.</b>		
<b>10224PK</b>	4.20mm Rod Size 7mm Hole Size Right Hand Side Black Nylon Door Rod End Clips Mazda # 9927-80-405	<b>25 Pcs.</b>		

## Retainers Door Trim Panel

<b>10575PK</b>	5/16" (8mm) Hole Size 10mm Stem Length 15mm Top Head Diameter Black Nylon Door Trim Panel Retainers Mazda # GA2A-68-AB1A	<b>10 Pcs.</b>		
<b>11907PK</b>	21/64" (8.50mm) Hole Size 16mm Stem Length 20mm Flange Diameter Caramel & Natural Door Trim Panel Retainers Ford # W708621-S300, W707593-S300, W706738-S300, W706739-S300 Mazda # EC01-68-AB1, 9XG1-10-37X, 9XG0-75-93X0	<b>25 Pcs.</b>		
<b>9081PK</b>	23/64" (9mm) Hole Size 14mm Stem Length 13mm Top Head Diameter Natural Nylon Door Trim Panel Retainers G.M. # 94226492 Isuzu # 8-94226-492-0 Mazda # 9927-40-825 Toyota # 67771-01010, 67771-12010F	<b>25 Pcs.</b>		
<b>10405PK</b>	23/64" (9mm) Hole Size 14mm Stem Length 14mm Head Diameter White Nylon Door Trim Panel Retainers Mazda # 9927-40-822 Toyota # 62581-14020	<b>25 Pcs.</b>		
<b>10749PK</b>	3/8" (9.50mm) Hole Size 14mm Stem Length 14mm Top Head Diameter White Nylon With Sealer Door Trim Panel Retainers Mazda # G18K-51-SJ3	<b>10 Pcs.</b>		

















## Retainers Grille

<b>18107PK</b>	9mm Stem Width 13mm Stem Length 9.00 x 22.00mm Head Size Black Nylon Grille Emblem Retainers Mazda # G46L-50-EB1	<b>25 Pcs.</b>		 <b>NEW!</b>
<b>9082PK</b>	13mm Width 22mm Overall Length Black Plastic Headlight Grille Clips G.M. # 94218027, H200-50-715 Isuzu # 8942180270, 58974-00008 Mazda # B092-50-715, BF67-S0715 Mitsubishi # MB153825 Toyota # 90467-13011, 90467-12020	<b>25 Pcs.</b>		



# Mazda





## Retainers Moulding

<b>15718PK</b>	25/64" (10mm) Hole Size 9mm Stem Length 10.00 x 15.00mm Top Head Size White Nylon Moulding Retainers Mazda # E11451W24	<b>25 Pcs.</b>		
<b>18113PK</b>	25/64" (10mm) Hole Size 12mm Stem Length 13.00 x 17.00mm Top Head Size Green Nylon With Sealer Rocker Panel Moulding Retainers Mazda # D10E-51-SJ3	<b>15 Pcs.</b>		
<b>9126PK</b>	25/64" (10mm) Hole Size 13mm Stem Length 18.50mm Flange Diameter Gray Nylon With Sealer Rocker Moulding Retainers Mazda # TD12-51-SJ3A	<b>15 Pcs.</b>		
<b>18112PK</b>	25/64" (10mm) Hole Size 14mm Stem Length 14mm Top Head Diameter Gray Nylon Wheel Arch Moulding Retainers Mazda # KD53-51-W24	<b>25 Pcs.</b>		
<b>18114PK</b>	25/64" (10mm) Hole Size 14mm Stem Length 15mm Top Head Diameter White Nylon With Sealer Wheel Opening Moulding Retainers Mazda # KD51-51-W24	<b>15 Pcs.</b>		
<b>18104PK</b>	7/16" (11mm) Hole Size 9mm Stem Length 10.00 x 15.00mm Top Head Size Gray Nylon With Sealer Stone Guard Moulding Retainers Mazda # KD53-51-SJ3A	<b>25 Pcs.</b>		
<b>12475PK</b>	31/64" (12mm) Hole Size 14mm Stem Length 14mm Top Head Diameter Black Nylon With Sealer Moulding Retainers Mazda # NE51-51-SJ3A	<b>10 Pcs.</b>		
<b>12919PK</b>	5/16 x 1/2" Hole Size 3/8" Stem Length 1/2 x 13/16" Head Size White Nylon With Sealer Front End Moulding Retainers Ford # W705849-S300 Mazda # 9XG0-73-88X0	<b>10 Pcs.</b>		













# Mazda

## Retainers Moulding



<b>12174PK</b>	1 1/32" (26mm) Hole Size 10mm Stem Length 14.00 x 20.00mm Head Size Gray Nylon With Sealer Moulding Retainers Mazda # BP4L-51-SJ3	<b>10 Pcs.</b>		
<b>11862PK</b>	15.50mm Width 23.10mm Length Stainless Steel Bumper Cover Retainers Ford # F32Z-17C756-S Mazda # GJ21-50-049	<b>50 Pcs.</b>		

# Mercedes

## Nuts Speed Type "U" for Sheet Metal Screws



















<b>13350PK</b>	#8 (4.20mm) Screw Size .50 - 2.50mm Panel Range 14mm Center Of Hole To Edge Zinc & Yellow Finish Speed Type "U" Nuts Mercedes # 123-994-08-45	<b>25 Pcs.</b>		
<b>11954PK</b>	#8 (4.20mm) Screw Size 3.00 - 4.00mm Panel Range 7mm Center of Hole to Edge Zinc Finish Speed Type "U" Nuts BMW # 0712-9-925-708, 07-12-9-901-645 Mercedes # 000-994-25-45	<b>50 Pcs.</b>		
<b>11286PK</b>	#10 (4.80mm) Screw Size .50 - 1.70mm Panel Range 7mm Center of Hole to Edge Zinc Finish Speed Type "U" Nuts BMW # 0712-9-925-737, 07-12-9-901-651 Mercedes # 000-994-06-45, 003-994-30-45	<b>50 Pcs.</b>		
<b>13301PK</b>	#10 (4.80mm) Screw Size .80 - 1.70mm Panel Range 11mm Center of Hole to Edge Zinc Finish Speed Type "U" Nuts BMW # 0711-9-916-945, 07-11-9-901-294, 07-11-9-901-299 Mercedes # 000-994-14-45	<b>50 Pcs.</b>		
<b>11915PK</b>	#10 (4.80mm) Screw Size .90 - 2.00mm Panel Range 9.40mm Center of Hole to Edge Zinc Finish Speed Type "U" Nuts Mercedes # 000-994-14-45	<b>25 Pcs.</b>		

## Nuts Nylon

<b>13344PK</b>	#6 (3.50mm) Screw Size 14mm Stem Length 9.50mm Head Size 6.50 x 7.00mm Hole Size Black Nylon Mercedes # 639-998-01-85 Replaces # 000-988-16-25	<b>25 Pcs.</b>		
----------------	--	----------------	---	---



# Mercedes

## Nuts Nylon



<b>13318PK</b>	#8 (4.20mm) Screw Size 16mm Stem Length 18mm Flange Diameter 7.80mm Hole Size Natural Nylon Screw Grommets Mercedes # 000-988-86-25	<b>25 Pcs.</b>		
<b>15716PK</b>	9/32" (7mm) Hole Size 5mm Stem Length 9mm Head Diameter White Nylon Moulding Grommet Mercedes # 000-987-10-81	<b>50 Pcs.</b>		
<b>13333PK</b>	9/32" (7mm) Stud Size 16mm Stem Length 16mm Head Diameter 8.50mm Hole Size Natural Nylon Tubular Nuts BMW # 51-44-7-780-135 Mercedes # 108-988-00-27	<b>25 Pcs.</b>		
<b>12477PK</b>	23/64" (9mm) Hole Size 12mm Stem Length 11.50mm Head Diameter White Nylon Moulding Insert Grommets Mercedes # 001-988-20-81, 001-988-76-81	<b>25 Pcs.</b>		
<b>12626PK</b>	23/64" (9mm) Hole Size 14mm Stem Length 4.50mm Inside Diameter Red Nylon Tubular Nuts Mercedes # 001-988-20-81	<b>50 Pcs.</b>		
<b>1404PK</b>	3/8" (9.50mm) Hole Size 6.70mm Stem Length 10.50mm Head Diameter 4.50mm Pin Diameter Red Nylon Moulding Grommets Mercedes # 000-988-15-81	<b>50 Pcs.</b>		
<b>16367PK</b>	4.8-1.61mm Screw Size 30mm Flange Overall Diameter 10mm Hex Size Black Nylon Fender Liner, Apron, & Under Cover Hex Flange Nuts Mercedes # 000-990-31-62	<b>25 Pcs.</b>		
<b>13299PK</b>	5mm Stud Size 10mm Hex Size 16mm Flange Diameter Black Nylon Flange Nuts BMW # 16-13-1-176-747 Mercedes # 003-990-02-51	<b>25 Pcs.</b>		
<b>12646PK</b>	5mm Stud Size 8mm Stem Length 10mm Hex Size 24mm Flange Diameter Black Nylon Rear Carpet Retainers Mercedes # 201-990-00-50	<b>25 Pcs.</b>		

# Mercedes



## Retainers Hood Insulation



<b>12542PK</b>	5/16" (8mm) Hole Size 12mm Stem Length 20mm Head Diameter Black Nylon Hood Insulation Retainers Mercedes # 001-988-03-25	<b>15 Pcs.</b>		
----------------	---	----------------	---	---

## Retainers Weatherstrip



<b>10657PK</b>	11/64" (4.20mm) Hole Size 12mm Stem Length 11mm Head Diameter Black Nylon Weatherstrip Retainers Chrysler # 6104908-AA G.M. # 20538173 Mercedes # 002-997-33-86	<b>50 Pcs.</b>		
----------------	--	----------------	---	---

## Retainers Push Type



<b>12551PK</b>	3/16" (4.80mm) Hole Size 7mm Stem Length 10mm Flange Diameter Black Nylon Push Type Retainers Mercedes # 000-990-03-92, 000-990-22-92 Volvo # 947-098	<b>50 Pcs.</b>		
----------------	---	----------------	---	---

<b>12540PK</b>	13/64" (5mm) Hole Size 11mm Stem Length 10mm Flange Diameter Black Nylon Rocker Panel Push Type Retainer BMW # 51161-881-149 Chrysler # 5073327AA Citroen # 7903072170 Mercedes # 000-990-34-92 Renault # 7703072116 V.W. # N102-593-01	<b>50 Pcs.</b>		
----------------	---	----------------	---	---

<b>12890PK</b>	15/64" (6mm) Hole Size 10mm Stem Length 10mm Flange Diameter Black Nylon Push Type Retainers Mercedes # 000-990-84-92	<b>25 Pcs.</b>		
----------------	--	----------------	---	---















<b>12394PK</b>	1/4" (6.30mm) Hole Size 15mm Stem Length 15mm Flange Diameter Black Nylon Scuff Plate Push Type Retainers BMW # 51-11-1-908-077 Mercedes # 000-990-54-92	<b>50 Pcs.</b>		
----------------	--	----------------	---	---

<b>11422PK</b>	9/32" (7mm) Hole Size 18mm Stem Length 16mm Flange Diameter Black Nylon Push Type Retainers Mercedes # 124-990-04-92	<b>15 Pcs.</b>		
----------------	---	----------------	---	---





<b>16406PK</b>	9/32" (7mm) Hole Size 19mm Stem Length 20mm Head Size Black Nylon Rear Fender Liner Push Type Retainers Mercedes # 000-991-41-40	<b>25 Pcs.</b>		
----------------	--	----------------	---	---

# Mercedes

## Retainers Push Type







<b>12858PK</b>	5/16" (8mm) Hole Size 8mm Stem Length 10.50 x 13.30mm Head Size Black Nylon Push Type Retainers Mercedes # 124-990-07-92, 124-990-07-92-9C75	<b>25 Pcs.</b>		
<b>12673PK</b>	5/16" (8mm) Hole Size 9mm Stem Length 20mm Flange Diameter Black Nylon Push Type Retainers Mercedes # 123-990-02-92	<b>10 Pcs.</b>		
<b>13225PK</b>	5/16" (8mm) Hole Size 10mm Stem Length 20mm Flange Diameter Black Nylon Hood Insulation, Cowl & Grille Push Type Retainers Chrysler # 6104900-A Mercedes # 230-990-01-92	<b>15 Pcs.</b>		
<b>15747PK</b>	5/16" (8mm) Hole Size 10mm Stem Length 20mm Head Diameter Black Nylon Interior Trim, Lower Engine & Trunk Cover Push Type Retainers Mercedes # 000-991-49-40	<b>15 Pcs.</b>		
<b>9652PK</b>	5/16" (8mm) Hole Size 14mm Stem Length 13mm Head Diameter Black Nylon Push-Type Retainer Mercedes # 000-990-37-92	<b>15 Pcs.</b>		
<b>12650PK</b>	21/64" (8.50mm) Hole Size 10mm Stem Length 12mm Head Diameter Dark Gray Nylon Push Type Retainers Mercedes # 123-990-00-92	<b>15 Pcs.</b>		
<b>11412PK</b>	21/64" (8.50mm) Hole Size 14mm Stem Length 20mm Flange Diameter Black Nylon Push Type Retainers BMW # 51471911992, 51470146782, 51470390017 Mercedes # 201-990-02-92	<b>25 Pcs.</b>		

## Retainers Phillips Screw



<b>11919PK</b>	13/64" (5mm) Hole Size 11mm Stem Length 12mm Flange Diameter Black Nylon Phillips Screw Retainers Mercedes # 000-990-40-92, 124-990-05-92-9051	<b>25 Pcs.</b>		
<b>12855PK</b>	13/64" (5mm) Hole Size 11mm Stem Length 12mm Flange Diameter Black Nylon Phillips Screw Retainers Mercedes # 000-990-44-92	<b>25 Pcs.</b>		

# Mercedes









## Retainers Phillips Screw

<b>13334PK</b>	15/64" (6mm) Hole Size 15mm Stem Length 17mm Flange Diameter Black Nylon Phillips Screw Retainers Mercedes # 000-990-46-92	<b>10 Pcs.</b>		
<b>12889PK</b>	1/4" (6.30mm) Hole Size 11mm Stem Length 16mm Flange Diameter Black Nylon Phillips Screw Retainers Mercedes # 123-990-05-92, 126-990-03-92	<b>15 Pcs.</b>		
<b>9968PK</b>	1/4" (6.30mm) Hole Size 29/32" Stem Length 5/8" Flange Diameter Black Nylon Phillips Screw Retainers G.M. # 20664091 Ford # N803946-S, W706350-S300, W706350-S3000, W710752-SSC Chrysler # 6502871 Mercedes # 000-991-52-40	<b>50 Pcs.</b>		

## Retainers Torx Screw













<b>9581PK</b>	21/64" (8.50mm) Hole Size 17mm Stem Length 30.50mm Flange Diameter Black Nylon Rocker Panel Moulding Torx Screw Retainers Mercedes # 001-990-01-92	<b>25 Pcs.</b>		 <b>NEW</b>
---------------	--	----------------	---	---

## Retainers Door Trim Panel







<b>13335PK</b>	15/64" (6mm) Hole Size 11mm Stem Length 13mm Head Diameter 3.50 - 13.50mm Panel Range Black Nylon Door Trim Panel Retainers Mercedes # 000-997-91-86	<b>10 Pcs.</b>		
<b>12464PK</b>	19/64" (7.50mm) Hole Size 11mm Stem Length 13mm Top Head Diameter White Nylon Door Trim Panel Retainers Mercedes # 003-988-41-78	<b>10 Pcs.</b>		
<b>15749PK</b>	5/16" (8mm) Hole Size 13mm Stem Length 13.30mm Top Head Diameter Yellow Nylon With Sealer Door Trim Panel Retainers Mercedes # 001-991-26-98	<b>15 Pcs.</b>		
<b>12474PK</b>	5/16" (8mm) Hole Size 12.50mm Stem Length 13mm Top Head Diameter Green Nylon Door Trim Panel Retainers Audi # 6Y0867260 Mercedes # 007-988-99-78, 007-988-34-78	<b>10 Pcs.</b>		

# Mercedes

## Retainers Door Trim Panel

<b>12800PK</b>	5/16" (8mm) Hole Size 13mm Stem Length 13mm Top Head Diameter Gray Nylon Door Trim Panel Retainers Mercedes # 000-990-57-92	<b>10 Pcs.</b>		
<b>10208PK</b>	21/64" (8.50mm) Hole Size 13mm Stem Length 13mm Top Head Diameter White Nylon With Sealer Door Trim Panel Retainers Mercedes # 006-988-43-78	<b>25 Pcs.</b>		
<b>9155PK</b>	21/64" (8.50mm) Hole Size 13.30mm Stem Length 13mm Top Head Diameter White Nylon With Sealer Door Pillar, Trim & Trunk Lining Retainers Mercedes # 000-991-01-98, 011-988-76-78	<b>15 Pcs.</b>		
<b>13305PK</b>	23/64" (9mm) Hole Size 14mm Stem Length 11.50mm Top Head Diameter Black Nylon Door Trim Panel Retainers Mercedes # 463-933-02-78	<b>25 Pcs.</b>		
<b>9583PK</b>	9.50 x 16.50mm Head Size 13.50mm Stem Length 14.50mm Overall Length White Nylon Scuff Plate Retainers Mercedes # 001-988-97-81	<b>25 Pcs.</b>		
<b>12463PK</b>	23/64" (9mm) Hole Size 15mm Stem Length 14mm Top Head Diameter White Nylon Door Trim Panel Retainers BMW # 51-41-1973-500 Mercedes # 000-991-71-71	<b>50 Pcs.</b>		

## Retainers Moulding



















<b>13353PK</b>	7/32" (5.50mm) Hole Size 6mm Stem Length 7mm Head Diameter White Nylon Hood & Trunk Moulding Clips Mercedes # 201-997-22-81	<b>15 Pcs.</b>		
<b>12476PK</b>	15/64" (6mm) Hole Size 22mm Overall Length 17mm Overall Width Natural Nylon Body Side Moulding Retainers Mercedes # 006-988-30-78	<b>10 Pcs.</b>		
<b>9587PK</b>	1/4" (6.50mm) Hole Size 7mm Stem Length 31mm Slotted Head Diameter Black Nylon Rocker Moulding Retainers Mercedes # 000-991-74-98	<b>15 Pcs.</b>		

22

















# Mercedes

## Retainers Moulding

<b>16356PK</b>	9/32" (7mm) Hole Size 6mm Stem Length 10mm Head Size Black Rubber Trunk Lid Hole Plugs Mercedes # 002-998-16-50	<b>50 Pcs.</b>		
<b>12553PK</b>	9/32" (7mm) Hole Size Black Nylon Grille Moulding Retainers Mercedes # 002-988-51-81	<b>10 Pcs.</b>		
<b>13297PK</b>	9/32" (7mm) Hole Size 6.70mm Stem Length 16.00 x 16.00mm Head Size White Nylon Moulding Retainers Mercedes # 001-988-49-81	<b>25 Pcs.</b>		
<b>13298PK</b>	9/32" (7mm) Hole Size 7mm Stem Length 12.00 x 16.00mm Head Size White Nylon Front Fender Moulding Retainers Mercedes # 001-988-44-81	<b>25 Pcs.</b>		
<b>13300PK</b>	9/32" (7mm) Hole Size 7mm Stem Length 12.50 x 15.50mm Head Size Yellow Nylon Front Fender Moulding Retainers Mercedes # 001-988-60-81	<b>25 Pcs.</b>		
<b>13303PK</b>	9/32" (7mm) Hole Size 7mm Stem Length 18.50mm Width White Nylon Front & Rear Door Moulding Retainers Mercedes # 001-988-46-81	<b>25 Pcs.</b>		
<b>13311PK</b>	5/16" (8mm) Hole Size 16mm Stem Length 23mm Width White Nylon With Rubber Boot Moulding Retainers Mercedes # 001-988-80-81	<b>15 Pcs.</b>		
<b>9586PK</b>	21/64" (8.50mm) Hole Size 12mm Stem Length 13mm Top Head Diameter Yellow Nylon With Sealer Door Garnish Moulding Retainers Mercedes # 000-991-63-98, 000-991-63-98-M22	<b>15 Pcs.</b>		
<b>13308PK</b>	23/64 (9mm) Hole Size 10.50mm Flange Diameter 1.25mm Panel Range Blue Nylon Moulding Grommets Mercedes # 000-988-55-81	<b>50 Pcs.</b>		

# Mercedes

## Retainers Moulding

<b>13272PK</b>	9mm Width 22mm Overall Height Black Spring Steel Moulding Clip V.W. # 4A0-867-276 Mercedes # 001-991-76-70	<b>25 Pcs.</b>		
<b>13352PK</b>	26mm Stem Length 28mm Overall Stem Length 12.00 x 16.00mm Head Diameter White Nylon Rocker Moulding Clips Mercedes # 140-698-00-82	<b>10 Pcs.</b>		
<b>13307PK</b>	1/2" (12.70mm) Hole Size 32mm Stem Length 19mm Width 25.50mm Height White Nylon Quarter Panel Moulding Retainers Mercedes # 001-988-63-81	<b>25 Pcs.</b>		
<b>16072PK</b>	51/64" (20mm) Hole Size 16mm Stem Length 24mm Head Diameter White Nylon Rocker Moulding Retainers Use With # 9587 Mercedes # 000-991-72-98	<b>15 Pcs.</b>		
<b>9599PK</b>	7/8" (22mm) Hole Size 16mm Stem Length 24mm Top Head Diameter White Nylon With Sealer Rocker Moulding Retainers Mercedes # 000-991-73-98	<b>10 Pcs.</b>		
<b>13309PK</b>	11mm Width 45mm Length 16mm Overall Height White Nylon Moulding Retainers Mercedes # 006-988-89-78	<b>25 Pcs.</b>		
<b>13376PK</b>	14.50 x 47.00mm Nylon Clip 43mm Metal Clip Length Black Finish Steel With White Nylon Front & Rear Upper Moulding Retainers Mercedes # 124-988-94-78	<b>10 Pcs.</b>		

22

# Mercedes

## Retainers Moulding

<b>13312PK</b>	19mm Width 20mm Length 20mm Over All Height White Nylon Moulding Clips Mercedes # 124-988-04-78	<b>25 Pcs.</b>		
<b>13302PK</b>	22.5mm Width 23mm Length White Nylon Moulding Clips Mercedes # 001-988-50-81	<b>25 Pcs.</b>		
<b>13304PK</b>	30mm Width 26.60mm Height White Nylon Body Side Moulding Clips Mercedes # 006-988-35-78	<b>10 Pcs.</b>		
<b>13310PK</b>	32.50mm Width 48mm Length 15mm Overall Height White Nylon Front & Rear Door Moulding Clips Mercedes # 007-988-71-78	<b>25 Pcs.</b>		

# Mitsubishi

## Nuts Nylon

<b>9111PK</b>	#6 (3.50mm) Screw Size 8.50mm Stem Length 10mm Head Diameter 6.50 x 7.50mm Hole Size Natural Nylon Headlight Screw Grommets AMC # 400141 G.M. # 380382 Mitsubishi # MS480001	<b>50 Pcs.</b>		
---------------	--	----------------	--	--