

Imports

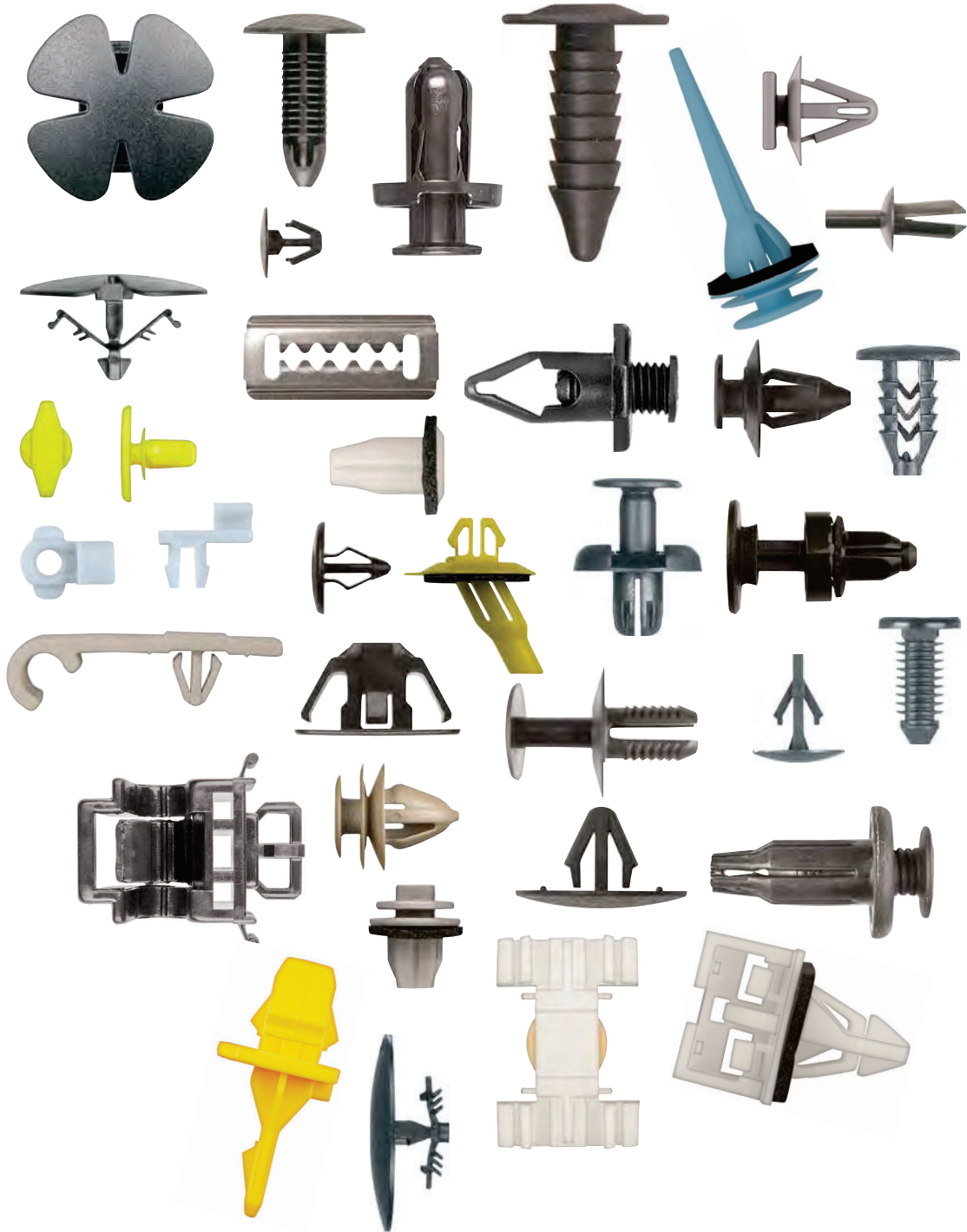

Isuzu

Retainers Door Trim Panel

9081PK 23/64" (9mm) Hole Size
14mm Stem Length
13mm Top Head Diameter
Natural Nylon
Door Trim Panel Retainers
G.M. # 94226492
Isuzu # 8-94226-492-0
Mazda # 9927-40-825
Toyota # 67771-12010F, 67771-01010

25 Pcs.

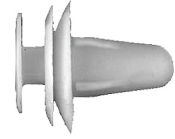

Reainers Grille

9082PK 13mm Width
22mm Overall Length
Black Plastic
Grille Headlight Clips
G.M. # 94218027, H200-50-715
Isuzu # 8942180270, 58974-00008
Mazda # B092-50-715, BF67-S0715
Mitsubishi # MB153825
Toyota # 90467-13011, 90467-12020

25 Pcs.



Jaguar

Retainers Phillips Screw

9580PK 15/32" (12mm) Hole Size
12mm Stem Length
24mm Flange Diameter
Black Nylon Radiator Support &
Air Deflector Retainers
Jaguar # XR831159

10 Pcs.



Retainers Headliner

10387PK 14.50mm Width
39.30mm Length
Black Nylon
Headliner Retainers
Jaguar # C2Z11575

15 Pcs.



10386PK 16mm Width
51mm Length
Black Nylon
Headliner Retainers
Jaguar # C2Z11576

15 Pcs.



Kia

Nuts Nylon

12062PK	11mm Head Size 9mm Stem Length 8mm Hole Size White Nylon Front & Rear Bumper Cover Nuts Kia # 86699-2D000	25 Pcs.		
10781PK	15mm Head Diameter 8mm Stem Length 10mm Hole Size Natural Nylon Headlight Assembly Grommets Hyundai # XG300/350 Kia # 92351-37000	25 Pcs.		
12056PK	14mm Hex Size 14mm Overall Height 25mm Flange Diameter Black Nylon Cowl Trim Retainers Kia # 0K95A-68615	25 Pcs.		



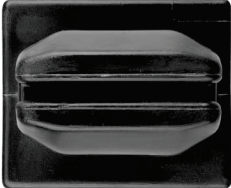
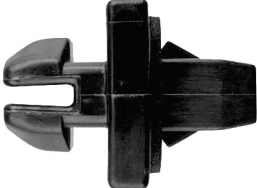

Retainers Grommet

12075PK	25.00 x 30.00mm Head Size 15mm Stem Length 35mm Overall Length Black Nylon With Sealer Bumper Cover Grommets Kia # 86591-25000	5 Pcs.		
----------------	---	---------------	---	--

Retainers Phillips Screw

12377PK	5/16" (8mm) Hole Size 12mm Stem Length 18mm Flange Diameter Black Nylon Grille Phillips Screw Retainers Kia # 0G032-50037-A	15 Pcs.		
5900PK	5/16" (8mm) Hole Size 18mm Stem Length 20mm Flange Size Black Nylon Inner Fender Phillips Screw Retainers Ford # NA01-56145 Kia # MNA01-56-145 Nissan # 63844-01A00	25 Pcs.		

Retainers Moulding

15873PK	5/16" (8mm) Hole Size 12mm Stem Length 13mm Top Head Diameter Gray Nylon Exterior & Interior Moulding Retainers Kia # 0K95-A-68401	50 Pcs.		
15978PK	7/16" (11mm) Hole Size 12mm Stem Length 10.00 x 12.00mm Top Head Size Gray Nylon With Sealer Liftgate Moulding Clips Kia # 87382-2W000	25 Pcs.		



Kia

Retainers Moulding



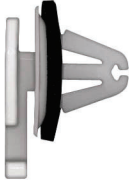

12602PK	15/32" (12mm) Hole Size 10mm Stem Length 10.50 x 9.50mm Top Head Size White Nylon With Sealer Moulding Retainers Kia # 87758-3E000, 87759-3E000, 87719-02500	25 Pcs.		
17914PK	15/32" (12mm) Hole Size 10mm Stem Length 10.00 x 12.00mm Top Head Size Red Nylon With Sealer Fender, Rocker & Wheel Moulding Retainers Kia # 87756-C5000	25 Pcs.		
14954PK	15/32" (12mm) Hole Size 10mm Stem Length 11.00 x 13.00mm Top Head Size Red Nylon With Sealer Wheel Flare & Body Side Moulding Retainers Kia # 87756-3E500	15 Pcs.		

Land Rover

Retainers Door Trim Panel



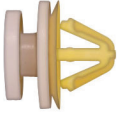



9682PK	5/16" (8mm) Hole Size 11mm Stem Length 14mm Top Head Diameter White Nylon With Sealer Pillar Retainers Land Rover # LR034389, LR053837	15 Pcs.		
16375PK	5/16" (8mm) Hole Size 15mm Stem Length 14.50mm Top Head Diameter White Nylon With Sealer Trim Panel, Tailgate & Luggage Compartment Retainers Land Rover # LR013135	15 Pcs.		

Retainers Moulding



16461PK	15/64" (6mm) Hole Size 13mm Stem Length 13mm Head Diameter Black Nylon Pillar, Rocker & Floor Moulding Push Type Retainers Land Rover # LR033144	15 Pcs.		
10441PK	5/16" (8mm) Hole Size 8mm Stem Length 12.50mm Top Head Diameter White & Yellow Nylon Moulding Retainers Land Rover # DYC101420	25 Pcs.		
16460PK	23/64" (9mm) Hole Size 15mm Stem Length 15.50mm Head Diameter Black Nylon Pillar Post Moulding Retainers Land Rover # LR002229	25 Pcs.		

Lexus



Nuts Nylon

12634PK	#4 (2.90mm) Screw Size 14mm Stem Length 9mm Head Size 7mm Hole Size Natural Nylon Side Moulding Screw Grommets Lexus # 90189-04207	25 Pcs.		
10808PK	#6 (3.50mm) Screw Size 7mm Stem Length 12.00 x 18.00mm Head Size 6.00 x 14.00mm Hole Size White Nylon Rocker Trim Screw Grommets Lexus # 90189-04059	25 Pcs.		
9481PK	#12 (5.50mm) Screw Size 24mm Stem Length 22.00 x 18.00mm Head Size White Nylon With Sealer Front Bumper Screw Grommets Lexus # 52197-30040	15 Pcs.		

Clips Retaining

15033PK	5/16" (8mm) Hole Size 14mm Stem Length 8.00 x 17.00mm Head Size Black Nylon Retaining Clips Lexus # 90467-06092	10 Pcs.		
----------------	--	----------------	---	---

Retainers Push Type

9329PK	9/32" (7mm) Hole Size 9mm Stem Length 17mm Flange Diameter Black Nylon Push Type Retainers Lexus # 90467-07117	10 Pcs.		
---------------	---	----------------	---	---

Retainers Phillips Screw

2143PK	9/32" (7mm) Hole Size 12mm Stem Length 20mm Flange Diameter Black Nylon Phillips Screw Retainers Lexus # 90467-07138, 90467-07138-C0	10 Pcs.		
1943PK	23/64" (9mm) Hole Size 23mm Stem Length 18mm Flange Diameter Black Nylon Bumper Cover Phillips Screw Retainers Lexus # 90467-09101	25 Pcs.		
10428PK	23/64" (9mm) Hole Size 26mm Stem Length 19mm Flange Diameter Black Nylon Phillips Screw Retainers Lexus # 90467-09143	10 Pcs.		
5895PK	23/64" (9mm) Hole Size 27mm Stem Length 15mm Flange Diameter Black Nylon Bumper Cover Phillips Screw Retainers Lexus # 90467-09093	10 Pcs.		

22

Lexus

Retainers Slotted Screw







11950PK	10mm Head Diameter 24mm Stem Length Black Nylon Front Bumper Cover & Fender Liner Pins Use With # 11951 & 17611 Lexus # 47749-50090 Toyota # 53879-30040	15 Pcs.		
11951PK	35mm Width 25mm Length Black Nylon Front Bumper Cover & Fender Liner Retainers Use With # 11950 Lexus # 53879-50020	10 Pcs.		
17611PK	32mm Width 39mm Length Black Nylon Front Bumper Cover Cover Retainers Use With Disco # 11950 Toyota # 53879-30040	5 Pcs.		

Retainers Moulding

10396PK	5/16" (8mm) Hole Size 20mm Stem Length 18mm Head Diameter Gray Nylon With Sealer Fender Moulding Retainers Lexus # 75492-60030	10 Pcs.		
10397PK	5/16" (8mm) Hole Size 20mm Stem Length 18mm Head Diameter Yellow Nylon With Sealer Fender Moulding Retainers Lexus # 75394-60060	10 Pcs.		
10493PK	23/64" (9mm) Hole Size 9mm Stem Length 18mm Head Diameter Pink Nylon With Sealer Moulding Retainers Lexus # 75395-33030	15 Pcs.		
10491PK	25/64" (10mm) Hole Size 10mm Stem Length 18mm Head Diameter Gray Nylon Rocker Panel Moulding Retainers Lexus # 75392-60030, 75392-60031	15 Pcs.		
13373PK	7/16" (11mm) Hole Size 10mm Stem Length 20mm Flange Diameter Green Nylon With Sealer Rear Lamp Moulding Retainers Lexus # 81496-50010	15 Pcs.		

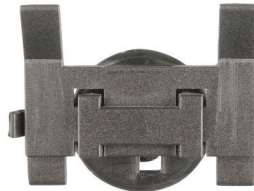



Lexus

Retainers Moulding

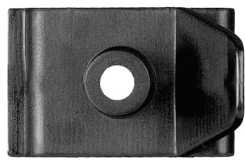
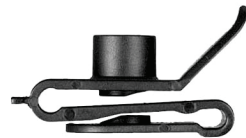

11853PK 18mm Head Diameter 24.50mm Overall Length Black Nylon Moulding Retainers Lexus # 75393-60030	15 Pcs.		
9330PK 5/16" (8mm) Hole Size 15mm Stem Length 24.70 x 30.30mm Head Size Black Nylon Side Moulding Retainers Lexus # 75049-33010	5 Pcs.		
9359PK 15mm Overall Width 55mm Overall Length Blue Nylon Windshield Moulding Retainers Lexus # 75545-53011	5 Pcs.		

Mazda

Nuts Nylon "U" Type Metric











1601PK #10 (4.80mm) Screw Size Up to 1.00mm Panel Range 11mm Center of Hole to Edge Black Nylon Fender Wheel Housing "U" Type Nuts G.M. # 94841226 Mazda LA01-56-135 Toyota # 53879-14010-A, 53879-14020, 53879-22030	15 Pcs.		
15214PK #10 (4.80mm) Screw Size Up to 1.00mm Panel Range 11mm Center of Hole to Edge Gray Nylon "U" Type Nuts Mazda # B455-56-135	25 Pcs.		
18105PK #10 (4.80mm) Screw Size Up to 1.00mm Panel Range 11mm Center of Hole to Edge Gray Nylon Front Bumper "U" Type Nuts Mazda # C274-50-133	25 Pcs.		

Nuts Nylon



1577PK #8 (4.20mm) Screw Size 6.50mm Stem Length 10mm Head Diameter 6mm Hole Size Natural Nylon Side Marker Light Screw Grommets Honda # 75522-611-000, 75522-611-0000 Mazda # 9991-00-412 Mitsubishi # MS-480001 Nissan # 96706-B0700, 97606-B0700 Toyota # 90189-04042, 95900-04036	50 Pcs.		
---	----------------	---	---

Mazda

Nuts Nylon

9659PK	#8 (4.20mm) Screw Size 15mm Stem Length 20mm Head Diameter White Nylon Screw Grommets Mazda # GJ6A-58-975	10 Pcs.		
1572PK	#8 (4.20mm) Screw Size 17mm Stem Length 16mm Head Diameter 8mm Hole Size Natural Nylon Screw Grommets Honda # 90661-SC7-0030, 90661-SC7-003 Mazda # H001-50-841, Mitsubishi # MS-480012 Nissan # 01651-00481, 74798-S90000, 01281-00231 Toyota # 90189-06042	25 Pcs.		
1614PK	#10 (4.80mm) Screw Size 8mm Stem Length 13mm Head Size 8.50mm Hole Size Natural Nylon Screw Grommets Honda # 75521-611-0000, 91619-SA5-003 Mazda # 9991-00-601 Nissan # 96706-P0105 Toyota # 90189-06010	25 Pcs.		
1296PK	#10 (4.80mm) Screw Size 8mm Stem Length 16.50mm Head Diameter 8.00 x 8.50mm Hole Size Natural Nylon Screw Grommets Honda # 90662-671-0030, 90662-671-003, 90662-SB-003 Mazda # 9991-00-503 Nissan # 68425-H5000, 62698-V7000	25 Pcs.		
14992PK	#10 (4.80mm) Screw Size 7.50mm Stem Length 11.50mm Head Diameter 8.00 x 8.00mm Hole Size Natural Nylon Spalsh Shield Grommets Mazda # 9991-00-501	25 Pcs.		

Nuts Specialty

16380PK	2.50mm Stud Size 8mm Head Diameter 6mm Hole Size Clear Nylon With Sealer Emblem Tubular Nuts Mazda # LA01-51-958	25 Pcs.		
16383PK	3.50mm Stud Size 12mm Outside Diameter Stainless Steel Emblem Push Nuts Mazda # 9957-83-000	50 Pcs.		

Clips Routing Cable & Tube

9820PK	15/64" (6mm) Hole Size 8mm Tubing or Cable Diameter Natural Nylon Tube/Cable Routing Clips Mazda # 9927-70901	25 Pcs.		
---------------	---	----------------	--	---

22

Mazda

Clips Routing Cable & Tube

18108PK 15/64" (6mm) Hole Size
9mm Stem Length
Holds 5mm Diameter Cable
Black Nylon
Hood Release Cable Clips
Mazda # D001-56-731



Clips Hood Release Cable

16379PK 8mm Rod Size
9.00 x 12.00mm Hole Size
26mm Overall Length
Black Nylon
Hood Prop Rod Clips
Mazda # L206-56-652A

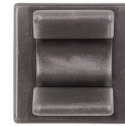

Retainers Hood Insulation

13315PK 15/64" (6mm) Hole Size
9mm Stem Length
20mm Head Diameter
Black Nylon
Hood Insulation Retainers
Ford # F22Z-16774-A, GA2A-56694
Mazda # G030-68-885-B-38



9522PK 15/64" (6mm) Hole Size
10mm Stem Length
14mm Head Diameter
Black Nylon
Hood Insulation Retainers
Ford # F1CZ-16774-A
Mazda # B455-56-741



13347PK 9/32" (7mm) Hole Size
10mm Stem Length
20mm Head Diameter
Black Nylon
Hood Insulation Retainers
Mazda # TD11-56-694



22

Retainers Weatherstrip

12509PK 5/32" (4mm) Hole Size
7mm Stem Length
9mm Head Diameter
Black Nylon
Weatherstrip Retaining Clips
Mazda # BP4K-58-762



16339PK 13/64" (5mm) Hole Size
10mm Stem Length
5.00 x 11.00mm Head Size
White Nylon
Weatherstrip Retainers
Mazda # KD45-58-762





12069PK 13/64" (5mm) Hole Size
10mm Stem Length
5.00 x 15.00mm Head Size
Natural Nylon
Weatherstrip Retainers
Ford # E7GZ-6120586-B
Hyundai # 86438-2B000
Mazda # G031-58-762
Toyota # 67867-89103, 97868-89101,
67867-28030



Mazda

Retainers Weatherstrip



15145PK	13/64" (5mm) Hole Size 10mm Stem Length 14mm Head Diameter Black Nylon Weatherstrip Retainers Mazda # J001-56-741	25 Pcs.		
----------------	--	----------------	--	---

Clips Retaining

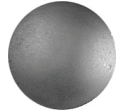
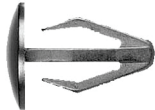

9886PK	7/32" (5.50mm) Hole Size 15mm Stem Length 11mm Head Diameter 5mm Panel Thickness Black Nylon Retaining Clips Mazda # 9926-40-543A Nissan # 01553-00291	50 Pcs.		
---------------	---	----------------	--	---

1634PK	15/64" (6mm) Hole Size 16mm Stem Length 14mm Head Diameter 5mm Panel Thickness Black Nylon Retaining Clips Honda # 90467-11005 Isuzu # 89421-76980 Mazda # 9926-40-658 Nissan # 76906-T3000, 76916-T3000	50 Pcs.		
---------------	---	----------------	--	---



10414PK	5/16" (8mm) Hole Size 15mm Stem Length 15mm Head Diameter Black Nylon Retaining Clips Mazda # B001-68-302-00 Toyota # 90950-01248	25 Pcs.		
----------------	---	----------------	--	---



10407PK	5/16" (8mm) Hole Size 18mm Stem Length 18mm Head Diameter Black Nylon Retaining Clips Mazda # 8133-50-022	25 Pcs.		
----------------	--	----------------	--	---

Retainers Push Type

12546PK	15/64" (6mm) Hole Size 12mm Stem Length 18mm Flange Diameter Gray Nylon Push Type Retainers Mazda # GJ21-68885-B69	25 Pcs.		
----------------	---	----------------	--	---

15853PK	15/64" (6mm) Hole Size 16mm Stem Length 14mm Head Diameter Black Nylon Interior Trim Push Type Retainers Mazda # B101-68-252-00	25 Pcs.		 NEW!
----------------	---	----------------	--	---









16341PK	15/64" (6mm) Hole Size 14mm Stem Length 18mm Head Diameter Black Nylon Rear Trunk Liner Push Type Retainers Mazda # B467-68-AC3-02	25 Pcs.		 NEW!
----------------	--	----------------	--	---

15951PK	9/32" (7mm) Hole Size 11mm Stem Length 11mm Head Diameter Black Nylon Push Type Retainers Mazda # S51S-51-833	15 Pcs.		 NEW!
----------------	--	----------------	--	---







22

Mazda

Retainers Push Type

11019PK	5/16" (8mm) Hole Size 12mm Stem Length 20mm Flange Diameter Black Nylon Cowl, Bumper & Fender Liner Push Type Retainers Mazda # L33X13209 Nissan # 01553-05323, 01553-05933	10 Pcs.		
18234PK	5/16" (8mm) Hole Size 13mm Stem Length 20mm Flange Diameter Black Nylon Bumper, Push Type Retainers Engine Cover, Fender & Quarter Panel Mazda # B45A-56-146A Toyota # 90118-WB048	25 Pcs.		
18109PK	5/16" (8mm) Hole Size 14mm Stem Length 20mm Head Diameter Black Nylon Bumper Cover & Fender Liner Push Type Retainers Mazda # BGV4-56-145	25 Pcs.		
13238PK	25/64" (10mm) Hole Size 15mm Stem Length 19.50mm Flange Diameter Black Nylon Push Type Retainers Mazda # GD7A-50-EA1	10 Pcs.		

Retainers Phillips Screw

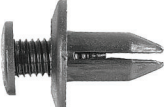
13396PK	13/64" (5mm) Hole Size 9mm Stem Length 8.50 x 12.00mm Head Size Black Nylon Cowl Vent Phillips Screw Retainers Ford # 3M8Z-1502316-A Mazda # GJ6W-50-715A	15 Pcs.		
9108PK	15/64" (6mm) Hole Size 9mm Stem Length 20mm Flange Diameter Black Nylon Phillips Screw Retainers Isuzu # 8942431900, 9841690750 Mazda # 1395-68-676 Nissan # 9926-50-635, 75775-41300, 23270-3895, 80915-29A66	15 Pcs.		
2015PK	9/32" (7mm) Hole Size 11mm Stem Length 14mm Flange Diameter Black Nylon Phillips Screw Retainers G.M. # 94198687 Honda # 90657-SA6-0030, 90657-SA6-003 Mazda # N304-13-356-A, N304-13-356B Subaru # 59130AA000 Toyota # 90467-07072, 90467-07072-22	25 Pcs.		
1603PK	9/32" (7mm) Hole Size 12mm Stem Length 15mm Flange Diameter Black Nylon Phillips Screw Retainers G.M. # 20426301 Mazda # 9926-50-625 Toyota # 90467-06017, 90467-06017-41, 90467-06017-C0	15 Pcs.		



Mazda

Retainers Phillips Screw





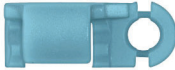
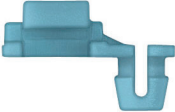



5920PK	5/16" (8mm) Hole Size 9mm Stem Length 20mm Flange Diameter Black Nylon Splash Shield Phillips Screw Retainers Honda # 90675-SB3-003, 90675-SB0-003 Mazda # FB01-56-964 Nissan # 63876-95596, 63876-D5596	25 Pcs.		
10747PK	5/16" (8mm) Hole Size 9mm Stem Length 20mm Flange Diameter Black Nylon Mud Guard Phillips Screw Retainers Mazda # BC1D-56-145	15 Pcs.		
9287PK	5/16" (8mm) Hole Size 12mm Stem Length 18mm Flange Diameter Black Nylon Phillips Screw Retainers Ford # MB-455-56143, W705845-S300 Hyundai # 86590-28000 Mazda # B092-51-833	10 Pcs.		
13273PK	5/16" (8mm) Hole Size 13mm Stem Length 13mm Flange Diameter Black Nylon Phillips Screw Retainers Mazda # G14S-50-EA1	25 Pcs.		
16335PK	5 x 20mm Screw 10mm Stem Length 18mm Flange 21/64" (8.50mm) Hole Size Phillips Truss Head Screw & Nylon Tail Lamp Grommets Mazda # GJ6A-51-14Y	15 Pcs.		
9600PK	25/64" (10mm) Hole Size 11mm Stem Length 20.00 x 30.00mm Head Size Nylon Phillips Screw Retainers Ford E7ZG-17A904-B Mazda BF67-50-033	10 Pcs.		
1998PK	25/64" (10mm) Hole Size 18mm Stem Length 20.00 x 30.00mm Flange Size Black Nylon Bumper Cover Phillips Screw Retainers Ford # E7GZ-17A904-G Mazda # BF82-50-233, MBF82-50-233 Nissan # 01553-01393	10 Pcs.		
10043PK	25/64" (10mm) Hole Size 20mm Stem Length 20.00 x 30.00mm Flange Size Black Nylon Bumper Cover Retainers Ford # E92Z-17C756-C Mazda # GJ21-50-034	10 Pcs.		

Mazda

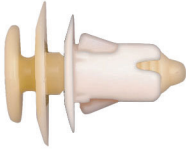

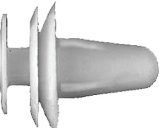

Clips Door Rod End

10223PK	4.20mm Rod Size 7mm Hole Size Left Hand Side Blue Nylon Door Rod End Clips Mazda # 9927-80-404	25 Pcs.		
10224PK	4.20mm Rod Size 7mm Hole Size Right Hand Side Black Nylon Door Rod End Clips Mazda # 9927-80-405	25 Pcs.		

Retainers Door Trim Panel

10575PK	5/16" (8mm) Hole Size 10mm Stem Length 15mm Top Head Diameter Black Nylon Door Trim Panel Retainers Mazda # GA2A-68-AB1A	10 Pcs.		
11907PK	21/64" (8.50mm) Hole Size 16mm Stem Length 20mm Flange Diameter Caramel & Natural Door Trim Panel Retainers Ford # W708621-S300, W707593-S300, W706738-S300, W706739-S300 Mazda # EC01-68-AB1, 9XG1-10-37X, 9XG0-75-93X0	25 Pcs.		
9081PK	23/64" (9mm) Hole Size 14mm Stem Length 13mm Top Head Diameter Natural Nylon Door Trim Panel Retainers G.M. # 94226492 Isuzu # 8-94226-492-0 Mazda # 9927-40-825 Toyota # 67771-01010, 67771-12010F	25 Pcs.		
10405PK	23/64" (9mm) Hole Size 14mm Stem Length 14mm Head Diameter White Nylon Door Trim Panel Retainers Mazda # 9927-40-822 Toyota # 62581-14020	25 Pcs.		
10749PK	3/8" (9.50mm) Hole Size 14mm Stem Length 14mm Top Head Diameter White Nylon With Sealer Door Trim Panel Retainers Mazda # G18K-51-SJ3	10 Pcs.		

















Retainers Grille

18107PK	9mm Stem Width 13mm Stem Length 9.00 x 22.00mm Head Size Black Nylon Grille Emblem Retainers Mazda # G46L-50-EB1	25 Pcs.		 NEW!
9082PK	13mm Width 22mm Overall Length Black Plastic Headlight Grille Clips G.M. # 94218027, H200-50-715 Isuzu # 8942180270, 58974-00008 Mazda # B092-50-715, BF67-S0715 Mitsubishi # MB153825 Toyota # 90467-13011, 90467-12020	25 Pcs.		

22

Mazda



Retainers Moulding

15718PK	25/64" (10mm) Hole Size 9mm Stem Length 10.00 x 15.00mm Top Head Size White Nylon Moulding Retainers Mazda # E11451W24	25 Pcs.		
18113PK	25/64" (10mm) Hole Size 12mm Stem Length 13.00 x 17.00mm Top Head Size Green Nylon With Sealer Rocker Panel Moulding Retainers Mazda # D10E-51-SJ3	15 Pcs.		
9126PK	25/64" (10mm) Hole Size 13mm Stem Length 18.50mm Flange Diameter Gray Nylon With Sealer Rocker Moulding Retainers Mazda # TD12-51-SJ3A	15 Pcs.		
18112PK	25/64" (10mm) Hole Size 14mm Stem Length 14mm Top Head Diameter Gray Nylon Wheel Arch Moulding Retainers Mazda # KD53-51-W24	25 Pcs.		
18114PK	25/64" (10mm) Hole Size 14mm Stem Length 15mm Top Head Diameter White Nylon With Sealer Wheel Opening Moulding Retainers Mazda # KD51-51-W24	15 Pcs.		
18104PK	7/16" (11mm) Hole Size 9mm Stem Length 10.00 x 15.00mm Top Head Size Gray Nylon With Sealer Stone Guard Moulding Retainers Mazda # KD53-51-SJ3A	25 Pcs.		
12475PK	31/64" (12mm) Hole Size 14mm Stem Length 14mm Top Head Diameter Black Nylon With Sealer Moulding Retainers Mazda # NE51-51-SJ3A	10 Pcs.		
12919PK	5/16 x 1/2" Hole Size 3/8" Stem Length 1/2 x 13/16" Head Size White Nylon With Sealer Front End Moulding Retainers Ford # W705849-S300 Mazda # 9XG0-73-88X0	10 Pcs.		

22

Mazda

Retainers Moulding

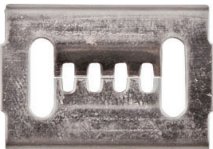

12174PK	1 1/32" (26mm) Hole Size 10mm Stem Length 14.00 x 20.00mm Head Size Gray Nylon With Sealer Moulding Retainers Mazda # BP4L-51-SJ3	10 Pcs.		
----------------	--	----------------	--	---



11862PK	15.50mm Width 23.10mm Length Stainless Steel Bumper Cover Retainers Ford # F32Z-17C756-S Mazda # GJ21-50-049	50 Pcs.		
----------------	---	----------------	---	---



Mercedes



Nuts Speed Type "U" for Sheet Metal Screws

13350PK	#8 (4.20mm) Screw Size .50 - 2.50mm Panel Range 14mm Center Of Hole To Edge Zinc & Yellow Finish Speed Type "U" Nuts Mercedes # 123-994-08-45	25 Pcs.		
----------------	--	----------------	--	---

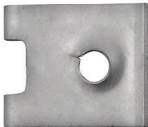
11954PK	#8 (4.20mm) Screw Size 3.00 - 4.00mm Panel Range 7mm Center of Hole to Edge Zinc Finish Speed Type "U" Nuts BMW # 0712-9-925-708, 07-12-9-901-645 Mercedes # 000-994-25-45	50 Pcs.		
----------------	--	----------------	--	--

11286PK	#10 (4.80mm) Screw Size .50 - 1.70mm Panel Range 7mm Center of Hole to Edge Zinc Finish Speed Type "U" Nuts BMW # 0712-9-925-737, 07-12-9-901-651 Mercedes # 000-994-06-45, 003-994-30-45	50 Pcs.		
----------------	---	----------------	---	---

13301PK	#10 (4.80mm) Screw Size .80 - 1.70mm Panel Range 11mm Center of Hole to Edge Zinc Finish Speed Type "U" Nuts BMW # 0711-9-916-945, 07-11-9-901-294, 07-11-9-901-299 Mercedes # 000-994-14-45	50 Pcs.		
----------------	---	----------------	---	---

















11915PK	#10 (4.80mm) Screw Size .90 - 2.00mm Panel Range 9.40mm Center of Hole to Edge Zinc Finish Speed Type "U" Nuts Mercedes # 000-994-14-45	25 Pcs.		
----------------	--	----------------	---	---

Nuts Nylon

13344PK	#6 (3.50mm) Screw Size 14mm Stem Length 9.50mm Head Size 6.50 x 7.00mm Hole Size Black Nylon Mercedes # 639-998-01-85 Replaces # 000-988-16-25	25 Pcs.		
----------------	--	----------------	---	---

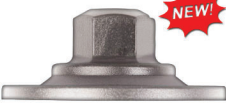
Mercedes

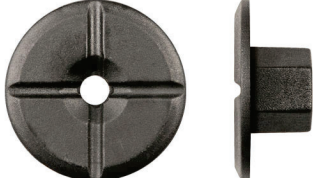

Nuts Nylon

13318PK	#8 (4.20mm) Screw Size 16mm Stem Length 18mm Flange Diameter 7.80mm Hole Size Natural Nylon Screw Grommets Mercedes # 000-988-86-25	25 Pcs.		
15716PK	9/32" (7mm) Hole Size 5mm Stem Length 9mm Head Diameter White Nylon Moulding Grommet Mercedes # 000-987-10-81	50 Pcs.		
13333PK	9/32" (7mm) Stud Size 16mm Stem Length 16mm Head Diameter 8.50mm Hole Size Natural Nylon Tubular Nuts BMW # 51-44-7-780-135 Mercedes # 108-988-00-27	25 Pcs.		
12477PK	23/64" (9mm) Hole Size 12mm Stem Length 11.50mm Head Diameter White Nylon Moulding Insert Grommets Mercedes # 001-988-20-81, 001-988-76-81	25 Pcs.		
12626PK	23/64" (9mm) Hole Size 14mm Stem Length 4.50mm Inside Diameter Red Nylon Tubular Nuts Mercedes # 001-988-20-81	50 Pcs.		
1404PK	3/8" (9.50mm) Hole Size 6.70mm Stem Length 10.50mm Head Diameter 4.50mm Pin Diameter Red Nylon Moulding Grommets Mercedes # 000-988-15-81	50 Pcs.		
16367PK	4.8-1.61mm Screw Size 30mm Flange Overall Diameter 10mm Hex Size Black Nylon Fender Liner, Apron, & Under Cover Hex Flange Nuts Mercedes # 000-990-31-62	25 Pcs.		
13299PK	5mm Stud Size 10mm Hex Size 16mm Flange Diameter Black Nylon Flange Nuts BMW # 16-13-1-176-747 Mercedes # 003-990-02-51	25 Pcs.		
12646PK	5mm Stud Size 8mm Stem Length 10mm Hex Size 24mm Flange Diameter Black Nylon Rear Carpet Retainers Mercedes # 201-990-00-50	25 Pcs.		



22

Mercedes



Retainers Hood Insulation



12542PK	5/16" (8mm) Hole Size 12mm Stem Length 20mm Head Diameter Black Nylon Hood Insulation Retainers Mercedes # 001-988-03-25	15 Pcs.		
----------------	---	----------------	---	---



Retainers Weatherstrip



10657PK	11/64" (4.20mm) Hole Size 12mm Stem Length 11mm Head Diameter Black Nylon Weatherstrip Retainers Chrysler # 6104908-AA G.M. # 20538173 Mercedes # 002-997-33-86	50 Pcs.		
----------------	--	----------------	---	---

Retainers Push Type

12551PK	3/16" (4.80mm) Hole Size 7mm Stem Length 10mm Flange Diameter Black Nylon Push Type Retainers Mercedes # 000-990-03-92, 000-990-22-92 Volvo # 947-098	50 Pcs.		
----------------	---	----------------	---	---

12540PK	13/64" (5mm) Hole Size 11mm Stem Length 10mm Flange Diameter Black Nylon Rocker Panel Push Type Retainer BMW # 51161-881-149 Chrysler # 5073327AA Citroen # 7903072170 Mercedes # 000-990-34-92 Renault # 7703072116 V.W. # N102-593-01	50 Pcs.		
----------------	---	----------------	---	---

12890PK	15/64" (6mm) Hole Size 10mm Stem Length 10mm Flange Diameter Black Nylon Push Type Retainers Mercedes # 000-990-84-92	25 Pcs.		
----------------	--	----------------	---	---

12394PK	1/4" (6.30mm) Hole Size 15mm Stem Length 15mm Flange Diameter Black Nylon Scuff Plate Push Type Retainers BMW # 51-11-1-908-077 Mercedes # 000-990-54-92	50 Pcs.		
----------------	--	----------------	---	---

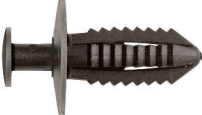









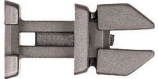

11422PK	9/32" (7mm) Hole Size 18mm Stem Length 16mm Flange Diameter Black Nylon Push Type Retainers Mercedes # 124-990-04-92	15 Pcs.		
----------------	---	----------------	---	---

16406PK	9/32" (7mm) Hole Size 19mm Stem Length 20mm Head Size Black Nylon Rear Fender Liner Push Type Retainers Mercedes # 000-991-41-40	25 Pcs.		
----------------	--	----------------	---	---





22

Mercedes

Retainers Push Type







12858PK	5/16" (8mm) Hole Size 8mm Stem Length 10.50 x 13.30mm Head Size Black Nylon Push Type Retainers Mercedes # 124-990-07-92, 124-990-07-92-9C75	25 Pcs.		
12673PK	5/16" (8mm) Hole Size 9mm Stem Length 20mm Flange Diameter Black Nylon Push Type Retainers Mercedes # 123-990-02-92	10 Pcs.		
13225PK	5/16" (8mm) Hole Size 10mm Stem Length 20mm Flange Diameter Black Nylon Hood Insulation, Cowl & Grille Push Type Retainers Chrysler # 6104900-A Mercedes # 230-990-01-92	15 Pcs.		
15747PK	5/16" (8mm) Hole Size 10mm Stem Length 20mm Head Diameter Black Nylon Interior Trim, Lower Engine & Trunk Cover Push Type Retainers Mercedes # 000-991-49-40	15 Pcs.		
9652PK	5/16" (8mm) Hole Size 14mm Stem Length 13mm Head Diameter Black Nylon Push-Type Retainer Mercedes # 000-990-37-92	15 Pcs.		
12650PK	21/64" (8.50mm) Hole Size 10mm Stem Length 12mm Head Diameter Dark Gray Nylon Push Type Retainers Mercedes # 123-990-00-92	15 Pcs.		
11412PK	21/64" (8.50mm) Hole Size 14mm Stem Length 20mm Flange Diameter Black Nylon Push Type Retainers BMW # 51471911992, 51470146782, 51470390017 Mercedes # 201-990-02-92	25 Pcs.		

Retainers Phillips Screw



11919PK	13/64" (5mm) Hole Size 11mm Stem Length 12mm Flange Diameter Black Nylon Phillips Screw Retainers Mercedes # 000-990-40-92, 124-990-05-92-9051	25 Pcs.		
12855PK	13/64" (5mm) Hole Size 11mm Stem Length 12mm Flange Diameter Black Nylon Phillips Screw Retainers Mercedes # 000-990-44-92	25 Pcs.		

Mercedes







Retainers Phillips Screw

13334PK	15/64" (6mm) Hole Size 15mm Stem Length 17mm Flange Diameter Black Nylon Phillips Screw Retainers Mercedes # 000-990-46-92	10 Pcs.		
12889PK	1/4" (6.30mm) Hole Size 11mm Stem Length 16mm Flange Diameter Black Nylon Phillips Screw Retainers Mercedes # 123-990-05-92, 126-990-03-92	15 Pcs.		
9968PK	1/4" (6.30mm) Hole Size 29/32" Stem Length 5/8" Flange Diameter Black Nylon Phillips Screw Retainers G.M. # 20664091 Ford # N803946-S, W706350-S300, W706350-S3000, W710752-SSC Chrysler # 6502871 Mercedes # 000-991-52-40	50 Pcs.		

Retainers Torx Screw



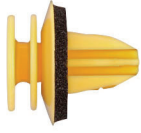







9581PK	21/64" (8.50mm) Hole Size 17mm Stem Length 30.50mm Flange Diameter Black Nylon Rocker Panel Moulding Torx Screw Retainers Mercedes # 001-990-01-92	25 Pcs.		 NEW!
---------------	--	----------------	---	--

Retainers Door Trim Panel

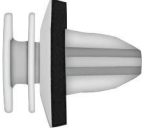



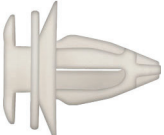

13335PK	15/64" (6mm) Hole Size 11mm Stem Length 13mm Head Diameter 3.50 - 13.50mm Panel Range Black Nylon Door Trim Panel Retainers Mercedes # 000-997-91-86	10 Pcs.		
12464PK	19/64" (7.50mm) Hole Size 11mm Stem Length 13mm Top Head Diameter White Nylon Door Trim Panel Retainers Mercedes # 003-988-41-78	10 Pcs.		
15749PK	5/16" (8mm) Hole Size 13mm Stem Length 13.30mm Top Head Diameter Yellow Nylon With Sealer Door Trim Panel Retainers Mercedes # 001-991-26-98	15 Pcs.		
12474PK	5/16" (8mm) Hole Size 12.50mm Stem Length 13mm Top Head Diameter Green Nylon Door Trim Panel Retainers Audi # 6Y0867260 Mercedes # 007-988-99-78, 007-988-34-78	10 Pcs.		

Mercedes

Retainers Door Trim Panel















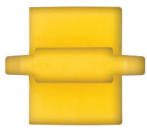

12800PK	5/16" (8mm) Hole Size 13mm Stem Length 13mm Top Head Diameter Gray Nylon Door Trim Panel Retainers Mercedes # 000-990-57-92	10 Pcs.		
10208PK	21/64" (8.50mm) Hole Size 13mm Stem Length 13mm Top Head Diameter White Nylon With Sealer Door Trim Panel Retainers Mercedes # 006-988-43-78	25 Pcs.		
9155PK	21/64" (8.50mm) Hole Size 13.30mm Stem Length 13mm Top Head Diameter White Nylon With Sealer Door Pillar, Trim & Trunk Lining Retainers Mercedes # 000-991-01-98, 011-988-76-78	15 Pcs.		
13305PK	23/64" (9mm) Hole Size 14mm Stem Length 11.50mm Top Head Diameter Black Nylon Door Trim Panel Retainers Mercedes # 463-933-02-78	25 Pcs.		
9583PK	9.50 x 16.50mm Head Size 13.50mm Stem Length 14.50mm Overall Length White Nylon Scuff Plate Retainers Mercedes # 001-988-97-81	25 Pcs.		
12463PK	23/64" (9mm) Hole Size 15mm Stem Length 14mm Top Head Diameter White Nylon Door Trim Panel Retainers BMW # 51-41-1973-500 Mercedes # 000-991-71-71	50 Pcs.		

Retainers Moulding

13353PK	7/32" (5.50mm) Hole Size 6mm Stem Length 7mm Head Diameter White Nylon Hood & Trunk Moulding Clips Mercedes # 201-997-22-81	15 Pcs.		
12476PK	15/64" (6mm) Hole Size 22mm Overall Length 17mm Overall Width Natural Nylon Body Side Moulding Retainers Mercedes # 006-988-30-78	10 Pcs.		
9587PK	1/4" (6.50mm) Hole Size 7mm Stem Length 31mm Slotted Head Diameter Black Nylon Rocker Moulding Retainers Mercedes # 000-991-74-98	15 Pcs.		

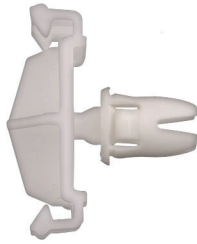









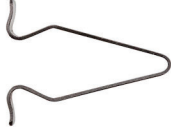

Mercedes

Retainers Moulding

16356PK	9/32" (7mm) Hole Size 6mm Stem Length 10mm Head Size Black Rubber Trunk Lid Hole Plugs Mercedes # 002-998-16-50	50 Pcs.		
12553PK	9/32" (7mm) Hole Size Black Nylon Grille Moulding Retainers Mercedes # 002-988-51-81	10 Pcs.		
13297PK	9/32" (7mm) Hole Size 6.70mm Stem Length 16.00 x 16.00mm Head Size White Nylon Moulding Retainers Mercedes # 001-988-49-81	25 Pcs.		
13298PK	9/32" (7mm) Hole Size 7mm Stem Length 12.00 x 16.00mm Head Size White Nylon Front Fender Moulding Retainers Mercedes # 001-988-44-81	25 Pcs.		
13300PK	9/32" (7mm) Hole Size 7mm Stem Length 12.50 x 15.50mm Head Size Yellow Nylon Front Fender Moulding Retainers Mercedes # 001-988-60-81	25 Pcs.		
13303PK	9/32" (7mm) Hole Size 7mm Stem Length 18.50mm Width White Nylon Front & Rear Door Moulding Retainers Mercedes # 001-988-46-81	25 Pcs.		
13311PK	5/16" (8mm) Hole Size 16mm Stem Length 23mm Width White Nylon With Rubber Boot Moulding Retainers Mercedes # 001-988-80-81	15 Pcs.		
9586PK	21/64" (8.50mm) Hole Size 12mm Stem Length 13mm Top Head Diameter Yellow Nylon With Sealer Door Garnish Moulding Retainers Mercedes # 000-991-63-98, 000-991-63-98-M22	15 Pcs.		
13308PK	23/64 (9mm) Hole Size 10.50mm Flange Diameter 1.25mm Panel Range Blue Nylon Moulding Grommets Mercedes # 000-988-55-81	50 Pcs.		







Mercedes

Retainers Moulding

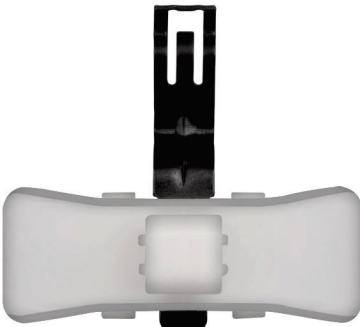
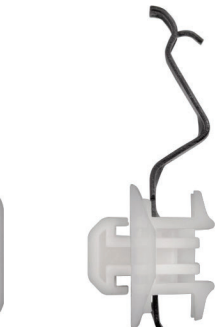
13272PK	9mm Width 22mm Overall Height Black Spring Steel Moulding Clip V.W. # 4A0-867-276 Mercedes # 001-991-76-70	25 Pcs.		
16357PK	3/8" (9.50mm) Hole Size 12mm Stem Length 20.00 x 30.00mm Head Size Black & Gray With Sealer Moulding Retainers Mercedes # 012-988-50-78	25 Pcs.		
13352PK	26mm Stem Length 28mm Overall Stem Length 12.00 x 16.00mm Head Diameter White Nylon Rocker Moulding Clips Mercedes # 140-698-00-82	10 Pcs.		
13307PK	1/2" (12.70mm) Hole Size 32mm Stem Length 19mm Width 25.50mm Height White Nylon Quarter Panel Moulding Retainers Mercedes # 001-988-63-81	25 Pcs.		
16072PK	51/64" (20mm) Hole Size 16mm Stem Length 24mm Head Diameter White Nylon Rocker Moulding Retainers Use With # 9587 Mercedes # 000-991-72-98	15 Pcs.		
9599PK	7/8" (22mm) Hole Size 16mm Stem Length 24mm Top Head Diameter White Nylon With Sealer Rocker Moulding Retainers Mercedes # 000-991-73-98	10 Pcs.		
13309PK	11mm Width 45mm Length 16mm Overall Height White Nylon Moulding Retainers Mercedes # 006-988-89-78	25 Pcs.		

Mercedes

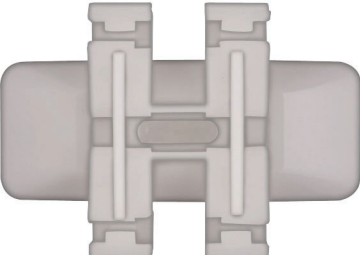
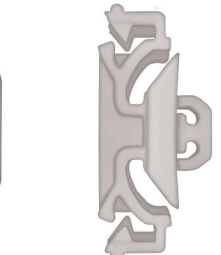

Retainers Moulding

13376PK	14.50 x 47.00mm Nylon Clip 43mm Metal Clip Length Black Finish Steel With White Nylon Front & Rear Upper Moulding Retainers Mercedes # 124-988-94-78	10 Pcs.		
13312PK	19mm Width 20mm Length 20mm Over All Height White Nylon Moulding Clips Mercedes # 124-988-04-78	25 Pcs.		
13302PK	22.5mm Width 23mm Length White Nylon Moulding Clips Mercedes # 001-988-50-81	25 Pcs.		
13304PK	30mm Width 26.60mm Height White Nylon Body Side Moulding Clips Mercedes # 006-988-35-78	10 Pcs.		
13310PK	32.50mm Width 48mm Length 15mm Overall Height White Nylon Front & Rear Door Moulding Clips Mercedes # 007-988-71-78	25 Pcs.		

22

Mitsubishi

Nuts Nylon

9111PK	#6 (3.50mm) Screw Size 8.50mm Stem Length 10mm Head Diameter 6.50 x 7.50mm Hole Size Natural Nylon Headlight Screw Grommets AMC # 400141 G.M. # 380382 Mitsubishi # MS480001	50 Pcs.		
---------------	--	----------------	--	---