

Imports

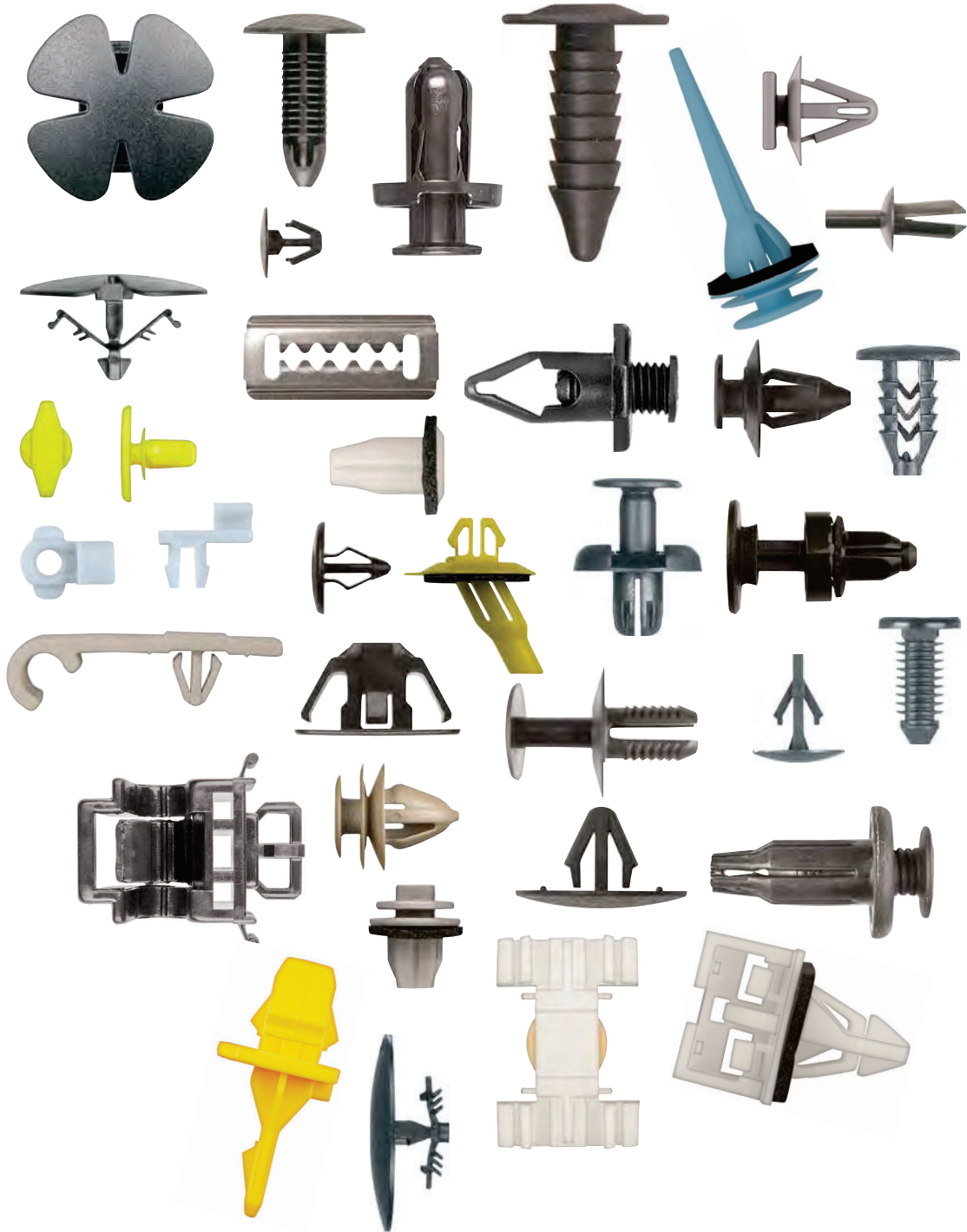

Renault

Nuts Barrel

9878PK 3/16" Stud Size
17/64" Hole Size
Black Nylon
Barrel Nuts
Ford # D7VY-6050074-A
Renault # 8934-201-767

100 Pcs.



Nuts Nylon

12667PK #8 (4.20mm) Screw Size
8.50mm Stem Length
9.70mm Head Diameter
6.50 x 7.50mm Hole Size
Natural Nylon With Sealer
Screw Grommets
G.M. # 9669486
Renault # 8934-201-262

25 Pcs.



9113PK #8 (4.20mm) Screw Size
9mm Stem Length
10mm Head Diameter
7mm Hole Size
Natural Nylon Radiator Grille
Screw Grommet
Chrysler # 6000943
Renault # 8934-201-263

100 Pcs.



Retainers Push Type

12540PK 13/64" (5mm) Hole Size
11mm Stem Length
10mm Flange Size
Black Nylon Rocker Panel
Push Type Retainer
BMW # 51161-881-149
Chrysler # 5073327AA
Citroen # 7903072170
Mercedes # 000-990-34-92
Renault # 7703072116
V.W. # N102-593-01

50 Pcs.



22

Subaru

Nuts Nylon

13324PK #10 (4.80mm) Screw Size
7mm Stem Length
14mm Head Diameter
8.50 x 9.50mm Hole Size
Yellow Nylon
Screw Grommets
Subaru # 66117-9000, 90930-0007

25 Pcs.



15343PK #10 (4.80mm) Screw Size
8.70mm Stem Length
17.00 x 17.00mm Head Size
White Nylon
Arm Rest Screw Grommets
Subaru # 94079AA000

15 Pcs.



13323PK #12 (5.50mm) Screw Size
18mm Stem Length
20mm Head Diameter
White Nylon With Sealer
Screw Grommets
Subaru # 91084-AA010

15 Pcs.



Subaru

Nuts Nylon

15341PK 25/64" (10mm) Hole Size
19.50mm Stem Length
25.00 x 33.00mm Head Size
Black Nylon With Sealer
Bumper Cover Grommets
Subaru # 99011FC000NN

15 Pcs.



Clips Routing Cable Tubing

16401PK 25/64" (10mm) Hole Size
20mm Overall Height
Holds 5mm Diameter Cable
Black Nylon
Trunk Release Cable Clips
Subaru # 909205056

25 Pcs.

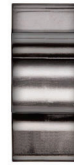

Retainers Shield

12084PK 9/32" (7mm) Hole Size
15mm Stem Length
18mm Head Diameter
Black Nylon
Trunk Interior Trim Retainers
Subaru # 99045-AE-03AMA

25 Pcs.



Retainers Hood Insulation

12852PK 1/4" (6.50mm) Hole Size
13mm Stem Length
30mm Head Diameter
Black Nylon
Insulation Retainers
Subaru # 90814-FC001

10 Pcs.



12092PK 9/32" (7mm) Hole Size
13mm Stem Length
30mm Head Diameter
3.00 - 11.00mm Panel Range
Black Nylon
Hood Insulators Retainers
Subaru # 90913-0074

15 Pcs.



15694PK 5/16" (8mm) Hole Size
15mm Stem Length
23mm Head Diameter
Black Nylon
Hood Insulation Retainers
Subaru # 909207031



50 Pcs.



22



Subaru

Retainers Weatherstrip

12455PK	13/64" (5mm) Hole Size 8mm Stem Length 10mm Head Diameter Black Nylon Weatherstrip Retainer Honda # 91520-SCC-003 Nissan # 01553-08961 Subaru # 90826FA000	25 Pcs.		
----------------	---	----------------	--	---



Retainers Push Type



16149PK	13/64" (5mm) Hole Size 8.50mm Stem Length 10mm Head Diameter Black Nylon Front & Rear Bumper Push Type Retainers Subaru # 909140059	15 Pcs.		
----------------	---	----------------	--	---

9650PK	15/64" (6mm) Hole Size 11mm Stem Length 14.90mm Flange Size Black Nylon Push Type Retainers Mitsubishi # MR288150 Subaru # 909130013	10 Pcs.		
---------------	--	----------------	--	---



15321PK	9/32" (7mm) Hole Size 10mm Stem Length 15mm Head Diameter Black Nylon Cowl & Bumper Push Type Retainers Subaru # 90914-0062	15 Pcs.		
----------------	---	----------------	--	---

12090PK	9/32" (7mm) Hole Size 10mm Stem Length 20mm Flange Diameter Black Nylon Bumper Push Type Retainers Subaru # 90914-0051	15 Pcs.		
----------------	---	----------------	--	---

15345PK	5/16" (8mm) Hole Size 10mm Stem Length 18mm Head Diameter Black Nylon Front Fender, Hood & Quarter Panel Push Type Retainers Subaru # 909140065	15 Pcs.		
----------------	---	----------------	--	---

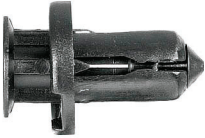

15751PK	5/16" (8mm) Hole Size 10mm Stem Length 20mm Head Diameter Black Nylon Front Fender Push Type Retainers Subaru # 909140068	15 Pcs.		
----------------	--	----------------	--	---

9294PK	25/64" (10mm) Hole Size 15mm Stem Length 18mm Flange Diameter Black Nylon Push Type Retainers Nissan # 01553-09241 Subaru # 57728-AC090	15 Pcs.		
---------------	---	----------------	--	---









12091PK	25/64" (10mm) Hole Size 15mm Stem Length 21mm Flange Diameter Black Nylon Fender & Grille Push Type Retainers Subaru # 90914-0007	15 Pcs.		
----------------	--	----------------	--	---

Subaru

Retainers Push Type



15337PK	7/16" (11mm) Hole Size 16mm Stem Length 25mm Head Diameter Black Nylon With Sealer Rocker, Pillar, Floor & Trim Push Type Retainers Subaru # 90914-0002	25 Pcs.		
12086PK	21/32" (17mm) Hole Size 16mm Stem Length 25mm Flange Diameter Black Nylon With Sealer Rocker Moulding Retainers Subaru # 90914-0055	5 Pcs.		



Retainers Phillips Screw

12079PK	9/32" (7mm) Hole Size 9mm Stem Length 15mm Flange Diameter Black Nylon Fender & Front Bumper Phillips Screw Retainers Subaru # 46064-AE000	15 Pcs.		
10413PK	9/32" (7mm) Hole Size 9mm Stem Length 20mm Flange Diameter Black Nylon Quarter Panel Moulding Phillips Screw Retainers G.M. # 96064506 Suzuki # 09409-07303-5ES Toyota # 90467-07044	10 Pcs.		
2015PK	9/32" (7mm) Hole Size 11mm Stem Length 14mm Flange Diameter Black Nylon Phillips Screw Retainers G.M. # 94198687 Honda # 90657-SA6-0030, 90657-SA6-003 Mazda # N304-13-356-A, N304-13-356B Subaru # 59130AA000 Toyota # 90467-07072, 90467-07072-22	25 Pcs.		
12078PK	9/32" (7mm) Hole Size 11mm Stem Length 20mm Flange Diameter Black Nylon Phillips Screw Retainers Subaru # 90913-0051	15 Pcs.		
12085PK	9/32" (7mm) Hole Size 12mm Stem Length 20mm Flange Diameter Black Nylon Fender Phillips Screw Retainers Subaru # 59122-AC030	15 Pcs.		
15324PK	5/16" (8mm) Hole Size 10mm Stem Length 18mm Head Diameter Black Nylon Engine Cover & Fender Liner Push Type Retainers Hyundai # 86590-3S000 Subaru # 90913-0067	15 Pcs.		



Subaru

Retainers Slotted Screw

12087PK	9/32" (7mm) Hole Size 11mm Stem Length 20mm Flange Diameter Black Nylon Slotted Fender Liner Retainers Subaru # 90914-0052	10 Pcs.		
----------------	---	----------------	--	---



15334PK	9/32" (7mm) Hole Size 12mm Stem Length 20mm Head Diameter Black Nylon Cowl Vent Push-Type Retainers Subaru # 90914-0063	10 Pcs.		
----------------	--	----------------	--	---



Retainers Door Trim Panel



15342PK	5/16" (8mm) Hole Size 10mm Stem Length 13mm Top Head Diameter Pink Nylon Door Trim Retainers Subaru # 65548GA250	25 Pcs.		
----------------	---	----------------	--	---

12089PK	23/64" (9mm) Hole Size 11.50mm Stem Length 14.00 x 11.00mm Top Head Diameter Black Nylon Door & Fender Trim Retainers Subaru # 90913-0109	25 Pcs.		
----------------	--	----------------	--	---

Retainers Cowl Panel

12093PK	9/32" (7mm) Hole Size 7mm Stem Length 14mm Flange Diameter 3mm Pin Diameter Natural Nylon Cowl Grommets Use With # 12094 Subaru # 91486-KJ000	25 Pcs.		
----------------	--	----------------	--	---

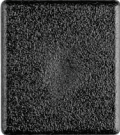
16387PK	9/32" (7mm) Hole Size 7.30mm Stem Length 16mm Head Diameter Gray Nylon Cowl Grille Grommets Use With # 12094 Subaru # 91486FL020	25 Pcs.		
----------------	--	----------------	--	---





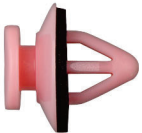

12094PK	3mm Pin Diameter 13mm Stem Length 16.00 x 18.00mm Head Size Black Nylon Cowl Retainers Use With #12093 Or 16387 Subaru # 91486-KJ010	25 Pcs.		
----------------	--	----------------	--	---

Retainers Moulding

14978PK	21/64" (8.50mm) Hole Size 11mm Stem Length 11.00 x 14.00mm Head Size Pink Nylon With Sealer Moulding Retainers Subaru # 90913-0008	25 Pcs.		
----------------	---	----------------	--	---

Subaru

Retainers Moulding



9207PK	23/64" (9mm) Hole Size 12mm Stem Length 11.00 x 14.00mm Top Head Size Black Nylon Fender, Rocker, Garnish Trim Retainers Subaru # 909130088	25 Pcs.	9 2 0 7 P K		
13445PK	5.90mm Hole Size 11mm Stem Length 9.00 x 11.00mm Top Head Size White Nylon Front Bumper Moulding Retainers Subaru # 57160FC010	25 Pcs.			
9584PK	24mm Head Diameter 16mm Stem Length 19.30mm Overall Length Black Nylon With Sealer Moulding Retainers Subaru # 909130118	15 Pcs.			

Suzuki

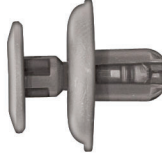
Retainers Screw Type

10570PK	9/32" (7mm) Hole Size 10mm Stem Length 20mm Flange Diameter Black Nylon Fender Splash Shield Push Type Retainers Suzuki # 09409-07332 Toyota # 90467-07164	10 Pcs.			
12916PK	23/64" (9mm) Hole Size 12mm Stem Length 16mm Flange Diameter Black Nylon Bumper Push Type Retainers G.M. # 30008324 Suzuki # 09409-07325	15 Pcs.			

Retainers Grille

10410PK	9/32" (7mm) Hole Size 14mm Stem Length 11mm Flange Diameter Black Nylon Radiator Grille Push Type Retainers G.M. # 96057847, 94847334 Suzuki # 09409-07313, 90467-07313 Toyota # 90467-07066, 90467-07066-J0	10 Pcs.			
----------------	--	----------------	--	---	---

Retainers Moulding

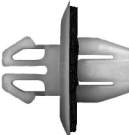
10392PK	23/64" (9mm) Hole Size 9mm Stem Length 18mm Head Diameter White Nylon With Sealer Rocker Panel Moulding Clips Suzuki # 77553-65D00 Toyota # 90467-11063	15 Pcs.			
----------------	---	----------------	--	---	---

Toyota

Nuts Nylon " U " Type Metric

1601PK

#10 (4.80mm) Screw Size
Up to 1.00mm Panel Range
11mm Center of Hole to Edge
Black Nylon Fender
Wheel Housing Type "U" Nuts
G.M. # 94841226
Mazda LA01-56-135
Toyota # 53879-14010-A, 53879-14020,
53879-22030

15 Pcs.

