

General Motors



General Motors

Screws Square Drive Truss Head Black Nylon

10566PK	14.00 x 34.00mm #3 Square Drive Truss Head 22mm Head Diameter Black Nylon Bumper & Door Insulator Screws G.M. # 11561438	25 Pcs.		
10539PK	7.50 x 35.00mm #3 Square Drive Truss Head 22mm Head Diameter Black Nylon Bumper Fascia Screws Chrysler # 6503819, 6503401 G.M. # 25631448	15 Pcs.		
11178PK	9.20 x 45.00mm #3 Square Drive Truss Head 22mm Head Diameter Black Nylon Bumper Fascia Screws G.M. # 25705182	15 Pcs.		

Nuts Push On Type Threaded Stud Metric

1621PK	6-1.00mm Screw Size 17mm Outside Diameter Flange Zinc Plated Push On Type Retainers Chrysler # 6501178, 6501192 Ford # N801192S36 G.M. # 11503736, 11609738, 14093869	100 Pcs.	
1043PK	8-1.25mm Screw Size 16mm Outside Diameter Flange Zinc Finish Push On Type Retainers Chrysler # 6501025 G.M. # 11502504, 11502853	100 Pcs.	
3010PK	8-1.25mm Screw Size 24mm Outside Diameter Flange Zinc Finish Bumper Strip Retainers Chrysler # 6501825 G.M. # 10009923	50 Pcs.	
9335PK	10 x 1.50mm Screw Size 20mm Outside Diameter Flange Black Finish Push On Type Retainers G.M. # 11502759	50 Pcs.	
1276PK	10-1.50mm Screw Size 24mm Outside Diameter Flange Dacromet Finish Push On Type Retainers G.M. # 11501849	50 Pcs.	

18

General Motors

Nuts Push On Type Threaded Stud Metric

1044PK 12-1.75mm Screw Size
21.40mm Outside Diameter Flange
Black Finish
Push On Type Retainers
G.M. # 11502737



9952PK 14-2.00mm Screw Size
25mm Outside Diameter Flange
Black Finish
Push On Type Retainers
G.M. # 11504119

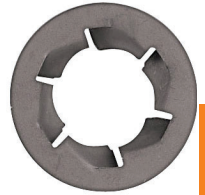

18

Retainers Grommet

16447PK 11/64" (4.50) Hole Size
5mm Stem Length
28mm Head Diameter
Black Nylon
Bumper Cover Grommets
G.M. # 15265199



NEW!



16450PK 5mm Stud
25/64" (10mm) Hole Size
8mm Stem Length
30mm Head Diameter
Black Nylon
Wheel House Liner Retainers
GM # 94530387



NEW!



16446PK 28mm Top Diameter
17.50mm Bottom Diameter
23mm Overall Height
Black Nylon
Body Mount Cushion Sleeves
G.M. # 15924986



NEW!



Nuts Push On Type Non-Threaded Stud Metric

9850PK 3.20mm Stud Size
9.50mm Outside Diameter Flange
Zinc Finish
Push On Type Retainers
G.M. # 11502794



1691PK 4mm Stud Size
11mm Outside Diameter Flange
Black Finish
Push On Type Retainers
G.M.



General Motors

Nuts Thread Cutting Metric

1041PK	5mm Stud Size 10mm Hex Size 15mm Flange Diameter Black Finish Thread Cutting Nuts G.M. # 11501835, 11508900, 11510062, 11501932	50 Pcs.		
1042PK	6.30mm Stud Size 11mm Hex Size 18mm Flange Diameter Zinc Finish Thread Cutting Nuts G.M. # 11501836, 11503432	50 Pcs.		
1622PK	8mm Stud Size 13mm Hex Size 20mm Flange Diameter Zinc Finish Thread Cutting Nuts G.M. # 11502507, 11509535, 11514282	100 Pcs.		

Nuts Lock Zinc Plated

11140PK	6-1.00mm Stud Size 11mm Hex Size 24mm Flange Diameter Metallic Gray Finish with Sealer Locking Washer Nuts G.M. # 11505865	25 Pcs.		
----------------	---	----------------	--	--

Nuts Hex Flange Type Metric

5797PK	5-.80mm Screw Size 8mm Hex Size 11.80mm Outside Diameter Flange Black Finish Metric Hex Flange Nuts G.M. # 11502722, 11502702	50 Pcs.		
11191PK	8-1.25mm Screw Size 13mm Hex Size 17mm Outside Diameter Flange Black Finish Metric Hex Flange Nuts G.M. # 11501889, 11507036, 11502609, 11514518, 11514596	25 Pcs.		
1017PK	10-1.50mm Screw Size 15mm Hex Size 21mm Outside Diameter Flange Black Finish Metric Hex Flange Nuts G.M. # 11501850	25 Pcs.		

Nuts Hex Loose Washer Metric

1639PK	5-.80mm Screw Size 10mm Hex Size 15mm Outside Diameter Loose Washer Black Finish Metric Hex Nuts AMC # 4200408 Ford # N621903-S61, N621903-S2 G.M. # 11504614	50 Pcs.		
---------------	--	----------------	--	--









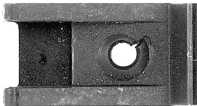

General Motors

Nuts Hex Loose Washer Metric

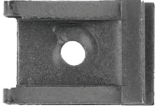

5910PK	6-1.00mm Screw Size 10mm Hex Size 16mm Outside Diameter Loose Barbed Washer Black Finish Metric Hex Nuts G.M. # 11505329, 11503752 V.W. # N90100001	25 Pcs.		
11896PK	6-1.00mm Screw Size 11mm Hex Size 19mm Outside Diameter Loose Barbed Washer Black Finish Metric Hex Nuts G.M. # 11503754, 11503756, 11505005, 11517293, 11609411	25 Pcs.		
5916XP	8-1.25mm Screw Size 13mm Hex Size 24mm Outside Diameter Loose Barbed Washer Black Finish Metric Hex Nuts Ford # N621940-S424 G.M. # 11503695, 11506117, 11516780, 11500401	25 Pcs.		

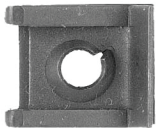
18

Nuts Speed Type "U" for Sheet Metal Screws









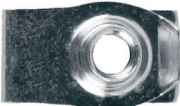

1350PK	#8 (4.20mm) Screw Size .025 - .150" Panel Range 3/8" Center of Hole to Edge Black Finish Speed Type "U" Nuts Ford # 381818-S2, 15650655 G.M. # 9424837, 9431530, 15650655	100 Pcs.		
5750PK	#8 (4.20mm) Screw Size .025 - .150" Panel Range 5/8" Center of Hole to Edge Black Finish Speed Type "U" Nuts Ford # 381863-S2 G.M. # 9440178, 9433155, 11504531	100 Pcs.		
11040PK	#8 (4.20mm) Screw Size .045 - .062" Panel Range 3/8" Center Of Hole To Edge Black Finish Speed Type "U" Nuts G.M. # 445429, 9422552	50 Pcs.		
1510PK	#8 (4.20mm) Screw Size .125 - .250" Panel Range 3/8" Center of Hole to Edge Black Finish Speed Type "U" Nuts G.M. # 9433156	100 Pcs.		
1192PK	#14 (6.30mm) Screw Size .025 - .150" Panel Range 3/8" Center of Hole to Edge Black Finish Speed Type "U" Nuts G.M. # 9431532	25 Pcs.		

Nuts Speed Type "U" for Machine Screws

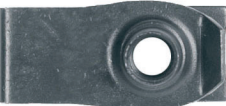



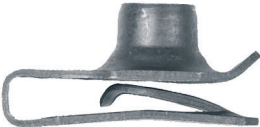

9848PK	1/4-20 Screw Size .064 - .125" Panel Range 9/16" Center of Hole to Edge Black Finish Speed Type "U" Nuts G.M. # 9431647, 22529733	100 Pcs.		
---------------	--	-----------------	--	---

General Motors

Nuts Extruded Type "U" Standard

938PK	10-24 Screw Size .025 - .125" Panel Range 15/32" Center of Hole to Edge Black Finish Extruded "U" Nuts Chrysler # 149251 G.M. # 152273	50 Pcs.		
2969PK	1/4-20 Screw Size .010 - .165" Panel Range 17/32" Center of Hole to Edge Black Finish Extruded "U" Nuts Ford # 45263-S2 G.M. # 1494252, 1480627	25 Pcs.		
5480PK	1/4-20 Screw Size .010 - .165" Panel Range 25/32" Center of Hole to Edge Black Finish Extruded "U" Nuts Ford # 45267 G.M. # 1494257	25 Pcs.		
1835PK	5/16-18 Screw Size .025 - .125" Panel Range 5/8" Center of Hole to Edge Black Finish Extruded "U" Nuts Chrysler # 3786805 G.M. # 1494253	25 Pcs.		
1836PK	5/16-18 Screw Size .010 - .170" Panel Range 27/32" Center of Hole to Edge Black Finish Extruded "U" Nuts Ford # 379831-S G.M. # 1494258	25 Pcs.		
5412PK	3/8-16 Screw Size .035 - .205" Panel Range 3/4" Center of Hole to Edge Black Finish Extruded "U" Nuts Ford # 45265-S2 G.M. # 1494254, 12337873	25 Pcs.		

















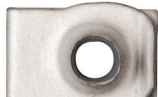

Nuts Extruded Type "U" Metric

10726PK	#8 (4.20-1.41mm) Screw Size .50 - 2.00mm Panel Range 10mm Center of Hole to Edge Zinc Organic Prevailing Torque Extruded "U" Nuts G.M. # 11516397	50 Pcs.		
10795PK	#8 (4.20-1.41mm) Screw Size .65 - 3.80mm Panel Range 9.50mm Center of Hole to Edge Zinc Organic Prevailing Torque Extruded "U" Nuts G.M. # 11513599 Ford # W704823-S439	25 Pcs.		
11043PK	#8 (4.20-1.41mm) Screw Size .65 - 3.80mm Panel Range 15mm Center of Hole To Edge Zinc Organic Prevailing Torque Extruded "U" Nuts G.M. # 11515638	25 Pcs.		

18

General Motors















Nuts Extruded Type "U" Metric

11339PK	#8 (4.20-1.41mm) Screw Size 2.00 - 3.00mm Panel Range 10.10mm Center of Hole to Edge Prevailing Torque 6.28 In-lbs Black Finish Extruded "U" Nuts G.M. # 11513700	25 Pcs.		
16078PK	#8 (4.20-1.41mm) Screw Size 2.00 - 3.00mm Panel Range 9.50mm Center of Hole to Edge Zinc Organic Extruded "U" Nuts G.M. # 11548579	25 Pcs.		
1021PK	4-.70mm Screw Size .80 - 4.00mm Panel Range 13.50mm Center of Hole to Edge Black Finish Extruded "U" Nuts G.M. # 11500655	50 Pcs.		
12893PK	5-.80mm Screw Size .60 - 3.80mm Panel Range 11mm Center of Hole To Edge Black Finish Extruded "U" Nuts Ford # N623331-S2, W520821-S439, W520821-S426 G.M. # 11505596, 11500656	50 Pcs.		
1012PK	5-.80mm Screw Size .80 - 4.00mm Panel Range 8mm Center of Hole to Edge Black Finish Extruded "U" Nuts G.M. # 11500657, 11504693	50 Pcs.		
16400PK	6-1.00mm Screw Size 1.80 - 2.50mm Panel Range 9mm Center of Hole to Edge Zinc Finish Extruded "U" Nuts Ford # N806728-S439 G.M. # 11517841	15 Pcs.		
9949PK	6-1.00mm Screw Size .50 - 2.30mm Panel Range 14mm Center of Hole to Edge G.M. #4435-M Finish Prevailing Torque Extruded "U" Nuts G.M.	25 Pcs.		
16081PK	6-1.00 Screw Size .70 - 2.00mm Panel Range 14mm Center of Hole to Edge Zinc Organic Extruded "U" Nuts G.M. # 11611321	10 Pcs.		
11030PK	6-1.00mm Screw Size .80 - 2.00mm Panel Range 14mm Center of Hole to Edge Zinc Organic Extruded "U" Nuts G.M. # 11570097	15 Pcs.		

18

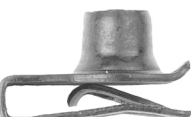
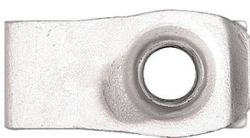
General Motors

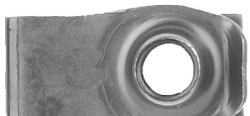
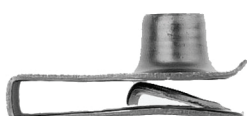

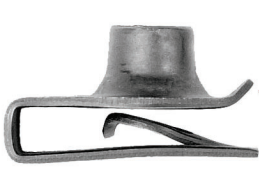

Nuts Extruded Type "U" Metric

10836PK	6-1.00mm Screw Size .80 - 4.00mm Panel Range 13.50mm Center of Hole to Edge Black Phosphate Organic Finish Prevailing Torque Extruded "U" Nuts Chrysler # 6101308 Ford # N800854-S1 G.M. # 11509005	25 Pcs.		
5596PK	6-1.00mm Screw Size .80 - 4.00mm Panel Range 13.50mm Center of Hole to Edge Black Finish Extruded "U" Nuts Ford # N623332, N623332-S2, N623332-S53, N623332-S100 G.M. # 11503957, 11503716, 1016937	25 Pcs.		
5650PK	6-1.00mm Screw Size 1.00 - 2.50mm Panel Range 19.50mm Center of Hole to Edge Black Finish Extruded "U" Nuts Ford # W520832-S424, W520832-S426 G.M. # 11503715, 11506099, 11508241	25 Pcs.		
9512PK	6-1.00mm Screw Size 3.40 - 6.30mm Panel Range 13.50mm Center of Hole to Edge Black Finish Extruded "U" Nuts Ford # N802331-S53 G.M. # 11504047	25 Pcs.		
5559PK	6.30-1.00mm Screw Size .80 - 4.00mm Panel Range 13.50mm Center of Hole to Edge Black Finish Extruded "U" Nuts G.M. # 11500658, 9433043, 11502785	25 Pcs.		
5560PK	8-1.25mm Screw Size .80 - 4.00mm Panel Range 14.50mm Center of Hole to Edge Black Finish Extruded "U" Nuts Chrysler # 6100042, 6101283 Ford # N623333-S2, N623333-S100 G.M. # 11500660, 11508925, 11502617	25 Pcs.		
16080PK	8-1.25 Screw Size .80 - 4.30mm Panel Range 21mm Center of Hole to Edge Zinc Organic Extruded "U" Nuts Ford # W520813-S439 G.M. # 11516150	15 Pcs.		
5557PK	8-1.25mm Screw Size .80 - 4.50mm Panel Range 20mm Center of Hole to Edge Black Finish Extruded "U" Nuts Ford # N623343-S100, N623343-S2 G.M. # 11500661, 11503317, 11516150	25 Pcs.		
5558PK	10-1.50mm Screw Size .90 - 6.00mm Panel Range 19mm Center of Hole to Edge Black Finish Extruded "U" Nuts G.M. # 11500662, 22531616	25 Pcs.		

18

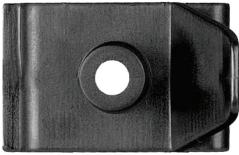
General Motors

Nuts Nylon Type "U" Metric

1601PK #10 (4.80mm) Screw Size Up to 1.00mm Panel Range 11mm Center of Hole to Edge Black Nylon Fender Wheel Housing "U" Type Nuts G.M. # 94841226 Mazda LA01-56-135 Toyota # 53879-14010-A, 53879-14020, 53879-22030	15 Pcs.		
15729PK #12 (5.50mm) Screw Size Up To 2.00mm Panel Range 12mm Center Of Hole to Edge Red Nylon "U" Type Nuts G.M. # 24449408	25 Pcs.		



















Nuts Nylon

11193PK #6 (3.50mm) Screw Size 6.50mm Stem Length 9.60mm Head Size 6.00 x 6.50mm Hole Size Natural Nylon With Sealer Rear Bumper Grommets G.M. # 11589183	50 Pcs.		
1297PK #6 (3.50mm) Screw Size 5/16" Stem Length 13/32" Head Size 9/32" Hole Size Natural Nylon Headlight Screw Grommets Chrysler # 6029501 G.M. # 1370853 V.W. # 179-813-883, 155-809-966	50 Pcs.		
9873PK #6 (3.50mm) Screw Size 8mm Stem Length 12.50mm Head Diameter 7.00 x 7.50mm Hole Size Natural Nylon Headlight Door to Radiator Grille Grommets G.M. # 1355003	50 Pcs.		
9111PK #6 (3.50mm) Screw Size 8.50mm Stem Length 10mm Head Size 6.50 x 7.50mm Hole Size Natural Nylon Headlight Screw Grommets AMC # 400141 G.M. # 380382 Mitsubishi # MS480001	50 Pcs.		
1202PK #6 (3.50mm) Screw Size 8.50mm Stem Length 13.00 x 17.00mm Head Size 7.00 x 15.00mm Hole Size Natural Nylon Grille Attachment Screw Grommets G.M. # 14032291	50 Pcs.		
637PK #6 (3.50mm) Screw Size 9mm Stem Length 14.00 x 21.00mm Head Size 7.00 x 18.50mm Hole Size Natural Nylon Rear Bumper Bar Screw Grommets G.M. # 1377030	100 Pcs.		

18













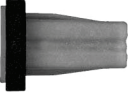
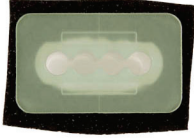

General Motors

Nuts Nylon

9085PK	#6 (3.50mm) Screw Size 3/8" Stem Length 15/64 x 23/64" Head Size 15/64" Hole Size White Nylon Marker Light Screw Grommets G.M. # 1254815	50 Pcs.		
1407PK	#6 (3.50mm) Screw Size 16.50mm Stem Length 14.70 x 20.80mm Head Size 7.10 x 20.30mm Hole Size Black Nylon High Torque Screw Grommets AMC # 8934-201-602 Chrysler # 6031869 G.M. # 10032838, 1264963	25 Pcs.		
11863PK	#6 to #8 Screw Size 8.30mm Stem Length 11.00 x 13.60mm Head Size Black Nylon Cowl Vent Nuts Chrysler # 6035274 G.M. # 15596280	25 Pcs.		
2940PK	#8 (4.20mm) Screw Size 17/64" Stem Length 31/64" Head Size 5/16" Hole Size Natural Nylon Headlamp Screw Grommets G.M. # 14013246	50 Pcs.		
9050PK	#8 (4.20mm) Screw Size 17/64" Stem Length 17/32" Head Size 11/32" Hole Size Natural Nylon Grille Screw Grommets G.M.	50 Pcs.		
1574PK	#8 (4.20mm) Screw Size 9/32" Stem Length 7/16" Head Size 5/16" Hole Size Natural Nylon Grille Screw Grommets G.M. # 3919773, 22649878, 22649879	100 Pcs.		
2980PK	#8 (4.20mm) Screw Size 9/32" Stem Length 7/16" Head Size 5/16" Hole Size Natural Nylon Grille Screw Grommets G.M. # 3893980, 347347	50 Pcs.		
1997PK	#8 (4.20mm) Screw Size 8mm Stem Length 13mm Head Diameter 7.50mm Hole Size Black Nylon Tail Light Screw Grommets G.M. # 3997391 V.W. # 179-813-881	25 Pcs.		
12667PK	#8 (4.20mm) Screw Size 8.50mm Stem Length 9.70mm Head Diameter 6.50 x 7.50mm Hole Size Natural Nylon With Sealer Screw Grommets G.M. # 9669486 Renault # 8934-201-262	25 Pcs.		

General Motors

Nuts Nylon

10553PK	#8 (4.20mm) Screw Size 13/32" Stem Length 1/2 x 21/32" Head Size 19/64 x 15/32" Hole Size Black Nylon Door Panel & Fender Shield Screw Grommets Chrysler # 6035821 G.M. # 11517759	25 Pcs.		
10556PK	#8 (4.20mm) Screw Size 11mm Stem Length 10mm Head Size 6.70mm Hole Size Natural Nylon Door Reveal Screw Grommets Ford # W710362 G.M. # 25647358	25 Pcs.		
11202PK	#8 (4.20mm) Screw Size 16mm Stem Length 12mm Head Size 7mm Hole Size Natural Nylon With Sealer Bumper Cover Grommets G.M. # 11561847	25 Pcs.		
10552PK	#8 (4.20mm) Screw Size 18mm Stem Length 13.00 x 22.00mm Head Diameter 6.00 x 16.50mm Hole Size Natural Nylon With Sealer Back Glass Moulding & Interior Trim Screw Grommets Ford # W705590-S300, W710459-S300 G.M. # 25649667	15 Pcs.		
15829PK	#10 (4.80mm) Screw Size 8mm Stem Length 13mm Head Diameter 8mm Hole Size White Nylon License Plate Grommets G.M. # 3783006	50 Pcs.		
17945PK	#10 (4.80mm) Screw Size 11mm Stem Length 9.50mm Head Diameter Natural Nylon Lower Door & Handle Interior Trim Grommets G.M. # 90230846, 94515248	25 Pcs.		
1560PK	#10 (4.80mm) Screw Size 11mm Stem Length 12mm Head Size 8 x 9mm Hole Size Natural Nylon Grille Screw Grommets G.M. # 94841764 Mitsubishi # MS480002, MS480009 Toyota # 90189-05013	50 Pcs.		
10551PK	#12 (5.50mm) Screw Size 9/16" Stem Length 5/8 x 3/4" Head Size 11/32 x 1/2" Hole Size Natural Nylon Door Handle Screw Grommets G.M. # 11517873	15 Pcs.		

18

General Motors

Nuts Nylon

9912PK	#12 (5.50mm) Screw Size 19mm Stem 16mm Head 8mm Square Hole Size Black Nylon Front & Rear Wheel Fender Liner Screw Grommets G.M. # 94854203 Toyota # 90189-06028	15 Pcs.		
9872PK	#14 (6.30mm) Screw Size 8mm Stem Length 14.30mm Head Diameter 8.50mm Hole Size Natural Nylon License Plate Screw Grommets G.M. # 380370	50 Pcs.		
1228PK	#14 (6.30mm) Screw Size 5/16" Stem Length 5/8" Head Size 13/32" Hole Size White Plastic License Plate Nuts Chrysler # 6023925 G.M. # 3907444	50 Pcs.		
17927PK	#14 (6.30mm) Screw Size 8mm Stem Length 16mm Head Size Black Nylon With Sealer Bumper, License Plate & Tail Light Screw Grommets G.M. # 25832258	10 Pcs.		
12664PK	#14 (6.30mm) Screw Size 11mm Stem Length 15mm Head Diameter 9.50mm Hole Size Natural Nylon Screw Grommets G.M. # 4755299	50 Pcs.		
10525PK	#14 (6.30mm) Screw Size 14mm Stem Length 20mm Head Size 8mm Hole Size Black Nylon License Plate Grommets G.M. # 22546934	50 Pcs.		
10550PK	#14 (6.30mm) Screw Size 17mm Stem Length 24mm Head Size 15mm Hole Size Black Nylon With Sealer Light Housing Screw Grommets G.M. # 15745990, 15289020, 11609535	15 Pcs.		
11391PK	#14 (6.30mm) Screw Size 23mm Stem Length 15.00 x 18.00mm Head Size White Nylon With Sealer Rear Bumper Screw Grommets G.M. # 25704358	10 Pcs.		
18261PK	4.80mm Stud Size 17mm Head Diameter 9.80mm Hole Size Black Rubber Tail Lamp Grommet G.M. # 11571225	10 Pcs.		

NEW!

General Motors

Nuts Nylon

15816PK	25/64" (10mm) Hole Size 15mm Stem Length 18mm Head Diameter White Nylon With Sealer Tail Light Grommets G.M. # 22884291	10 Pcs.		
16309PK	25/64" (10mm) Hole Size 17.50mm Overall Length 19mm Head Diameter Orange Nylon With Sealer Tail Lamp Grommets G.M. # 84221533	10 Pcs.		
9712PK	7/16" (11mm) Hole Size 9mm Stem Length 13mm Head Diameter White Nylon Park & Turn Signal Grommets Ford # N811169-S, W705550-S300 G.M. # 10423331 Toyota # 90075-10801, 90189-06111	50 Pcs.		
13368PK	7/16" (11mm) Hole Size 16mm Stem Length 16mm Head Diameter White Nylon Fog Light Grommets G.M. # 11570830	15 Pcs.		
11162PK	19/32" (15mm) Hole Size 21mm Stem Length 24mm Head Diameter .90mm Thick Panel Black Nylon With Sealer Tail Light Grommets G.M. # 11561987	15 Pcs.		
10554PK	13 x 20mm Head Size 17mm Stem Length 9.00 x 16.00mm Hole Size Black Nylon Rear Light Housing Screw Grommets Chrysler # 5113360-AA G.M. # 15284612, 11609536, 15745991	15 Pcs.		
10498PK	13 x 20mm Head Size 17.50mm Stem Length 8.75 x 15.75mm Hole Size Blue Nylon With Sealer Headlight Screw Grommets G.M. # 11561382, 11610198	10 Pcs.		
10526PK	15mm Head Diameter 17mm Stem Length 11mm Hole Size Black Nylon With Sealer Tail Light Grommets G.M. # 11561655, 11609862, 11610705	5 Pcs.		
11189PK	9.50 x 13.50mm Hole Size 18mm Stem Length 17.50 x 21.50mm Head Size Black Nylon Fascia Grommets Use With #11190 G.M. # 22603044	15 Pcs.		

18

General Motors

Nuts Nylon

11190PK 5mm Pin Diameter
19.70mm Pin Length
3.30mm Panel Range
Black Nylon
Front Bumper Fascia
Hinged Pin Retainers
Use With #11189
G.M. # 22615352, 11588782, 22603043



Nuts Miscellaneous Metric

12273PK #6 (3.50mm) Screw Size
10mm Width
18mm Overall Height
Zinc Finish
Bumper & Grille Fasteners
Chrysler # 4806226-AA, 68004187-AA
Ford # W710754-S439
G.M. # 11562364



9199PK #8 (4.20mm) Screw Size
Zinc Finish
Radiator Grille Nuts
Ford # N802865-S100
G.M. # 15686142, 11561448



11258PK #8 (4.20mm) Screw Size
8.65mm Hole Size
Zinc Finish
Fender Bracket Push In Nuts
G.M. # 11518531, 11609952



12983PK #8 (4.20mm) Screw Size
6.00 x 16.00mm Head Size
7mm Overall Height
Magni-565 Finish
Front Bumper Nuts
G.M. # 11609952

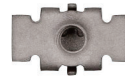

16065PK #8 (4.20mm) Screw Size
.50 - 1.00mm Panel Range
8.55mm Square Hole Size
Green Finish With Silicone Pad
Door Panel & Bumper Nuts
G.M. # 11546868



11032PK #8 (4.20mm) Screw Size
.70 - 2.30mm Panel Range
8.70mm Hole Size
Blue Finish
Mid Panel Nuts
Chrysler # 6509432AA
Ford # W716529-S900
G.M. # 1570654



10733PK #8 (4.20mm) Screw Size
.70 - 1.50mm Panel Range
8.70mm Hole Size
Gray Finish With Sealer
Tail Light Quarter Panel Nuts
Ford # W714171-S439
G.M. # 11569711



















11034PK #8 (4.20mm) Screw Size
9.00 x 11.00mm Hole Size
Black Finish
Dash Panel Nuts
Ford # N803685S
G.M. # 14083173, 17997722, 17988488



General Motors

Nuts Miscellaneous Metric

15864PK	#8 (4.20-1.41mm) Screw Size 1.40 - 5.00mm Panel Range 10.90 x 13.00mm Hole Size Green Metallic Finish Bracket Retainer Nuts G.M. # 11548673	15 Pcs.		
15691PK	#8 (4.20-1.41mm) Screw Size Zinc Organic Center Console Door, Front Lights, Grille, Lift Gate Nuts With Silicone Pad G.M. # 11610157	10 Pcs.		
10143PK	17/32" (13.50mm) Hole Size 11mm Overall Length Zinc Finish Headlamp Assembly Nuts G.M. # 11570015	15 Pcs.		
9597PK	6-1.00mm Screw Size Zinc Organic License Plate Nuts G.M. # 15707256	10 Pcs.		
18094PK	6-1.00 Screw Size .70 - 3.80mm Panel Range 9.25 x 13.75mm Hole Size Zinc Finish Rear Bumper Bracket Nuts G.M. # 11547582	25 Pcs.		
13423PK	6-1.00 Screw Size 11mm Overall Height Zinc Organic Radiator Grille & Front End Panel Nuts G.M. # 11518937	10 Pcs.		
15902PK	6-1.00mm Screw Size 12mm Overall Height Organic Zinc Finish Front Fender Panel Nuts G.M. # 11610544	10 Pcs.		
11984PK	5.80mm Stud Size 13mm Hex Size 25mm Washer Diameter Black Nylon Grille Retainer Nuts Use With # 11983 Camaro 2010 Cadillac SRS & SRX G.M. # 11610748	25 Pcs.		

18

General Motors

Nuts Miscellaneous Metric

11983PK 5.80mm Stem Diameter
25.50mm Stem Length
25mm Head Diameter
Black Nylon
Slotted Grille Retainers
Use With # 11984
Camaro 2010 Cadillac SRS & SRX
G.M. # 11610747

25 Pcs.



Nutserts Hex Type Automotive

12444PK 6-1.00mm Thread Size
8mm Hex Size
12mm Flange Diameter
.65 - 2.00mm Grip Range
Zinc Finish With Sealer
Hex Type Steel Nutserts
Ford # N803763-S100
G.M. # 15685099, 11518684

15 Pcs.



12440PK 6-1.00mm Thread Size
9.50mm Hex Size
13mm Flange Diameter
.70 - 4.00mm Grip Range
Zinc Finish Front Core Support
Hex Type Steel Nutserts
G.M. # 11519952

15 Pcs.



12441PK 8-1.25mm Thread Size
12.50mm Hex Size
17mm Flange Diameter
.70 - 4.00mm Grip Range
Zinc Finish
Hex Type Steel Nutserts
G.M. # 11519960

15 Pcs.



Nutserts Round Type

12678PK 6-1.00mm Thread Size
.70 - 4.20mm Grip Range
10mm Drill Size
Yellow Zinc Knurled Shank
Round Type Nutserts
G.M. # 10237960

25 Pcs.



Nutserts Hex Type

12715PK 1/4-20 Thread Size
.027 - .165" Grip Range
9/64" Drill Size
Yellow Zinc Finish
Hex Type Nutserts
G.M. # N/A

15 Pcs.



10210PK 5-.80mm Thread Size
.50 - 3.30mm Grip Range
7.14mm Drill Size
Yellow Zinc
Hex Type Nutserts

15 Pcs.



10211PK 6-1.00mm Thread Size
.70 - 4.20mm Grip Range
9.53mm Hex Size
Yellow Zinc
Hex Type Nutserts
G.M. # 10281487



15 Pcs.









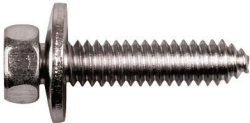
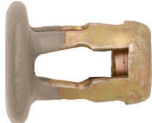

18

General Motors

Nuts Jack

9371PK	1/4-20 Thread Size 5/8" Stem Length 3/16 - 3/8" Grip Range Raintite Sealer Type Steel Jack Nuts Chrysler # 6031438 G.M. # 367292	25 Pcs.		
9541PK	1/4-20 x 1" 5/8" Outside Diameter Chrome Finish Outside Mirror Mounting Bolts Use With # 9371 G.M. # 367291, 10001670, 474821	25 Pcs.		
1793PK	6-1.00mm Thread Size Roof Rack Mounting Raintite Sealer Type Steel Jack Nuts G.M. # 14007940	10 Pcs.		
9561PK	1/4-20 x 1" Screw Size Mirror Mounting Screw & Jack Nut Assembly G.M. # 367292	10 Sets		

Nuts Brass Insert Rubber Well

10035PK	#8-32 Screw Size 5/16" Hole Size 7/16" Stem Length .015 - .178" Grip Range Black Rubber Well Nuts G.M. # 14048060	25 Pcs.		
15953PK	10-24 Screw Size 3/8" Hole Size 37/64" Length .030 - .227" Grip Range Black Rubber With Brass Insert Well Nuts G.M. # 3876130	25 Pcs.		 NEW!
11284PK	#10-32 Screw Size 3/8" Hole Size 5/8" Stem Length .035 - .232" Grip Range Black Rubber Well Nuts G.M. # 12338025	10 Pcs.		
11899PK	6-1.00mm Screw Size 12.70mm Hole Size 15mm Stem Length 20mm Flange Diameter .015 - .094" Grip Range Roof Rack Mounting Rubber Well Nuts G.M. # 20130258, 14002811	10 Pcs.		



















Rubber Products

13261PK	9/64" (3.60mm) Hole Size 3/4" Stem Length 5/16" Head Diameter Black Rubber General Purpose Bumpers G.M. # 1304225	25 Pcs.		
----------------	--	----------------	---	---

18

General Motors

Rubber Products

13262PK	5/32" (3.97mm) Hole Size 27/32" Stem Length 21/64" Head Diameter Black Rubber Glove Box Door Bumpers G.M. # 3693292	25 Pcs.			
13263PK	17/64" (6.75mm) Hole Size 5/16" Stem Length 31/64" Head Diameter Black Rubber License Plate Bumpers G.M. # 3745361, 3762180	25 Pcs.			
9881PK	17/64" (6.75mm) Hole Size 21/64" Stem Length 1/2" Head Diameter Black Rubber Door & Quarter Glass Bumpers G.M. # 4081765	25 Pcs.			
13265PK	17/64" (6.75mm) Hole Size 11/32" Stem Length 5/8" Head Diameter Black Rubber Hood Side Bumpers G.M. # 3688811	25 Pcs.			
13266PK	17/64" (6.75mm) Hole Size 23/64" Stem Length 31/64" Head Diameter Black Rubber Door Bumpers G.M. # 4563173, 4565415	25 Pcs.			
13267PK	1/4" (6.35mm) Hole Size 5/8" Stem Length 5/8" Head Diameter Black Rubber General Purpose Bumpers G.M. # 972724	25 Pcs.			
13268PK	9/32" (7.14mm) Hole Size 15/32" Stem Length 23/32" Head Diameter Black Rubber General Purpose Bumpers G.M. # 3664645	25 Pcs.			
13269PK	1/4" (6.35mm) Hole Size 3/8" Stem Length 3/4" Head Diameter Black Rubber General Purpose Bumper G.M. # 3655015	25 Pcs.			
13270PK	27/64" (10.72mm) Hole Size 7/8" Diameter Black Rubber Trunk & Hood Bumpers G.M. # 4137121	25 Pcs.			

18

General Motors

Rubber Products

16449PK 7/16" (11mm) Slot Size
27mm Overall Height
20mm Overall Width
Black Rubber
Hood Prop Buffer
G.M. # 22755704

25 Pcs.



Clips Wire Loom Routing

9690PK 1/4" Inside Diameter
3/8" Outside Diameter
Black Nylon
Wire Loom Routing Clips
G.M. # 12015631

15 Pcs.



18

1237PK 11/32" Inside Diameter
1/2" Outside Diameter
Black Nylon
Wire Loom Routing Clips
G.M. # 8911473

25 Pcs.



1238PK 13/32" Inside Diameter
19/32" Outside Diameter
Black Nylon
Wire Loom Routing Clips
G.M. # 8911497

25 Pcs.



1239PK 1/2" Inside Diameter
11/16" Outside Diameter
Black Nylon
Wire Loom Routing Clips
G.M. # 8911472

25 Pcs.





















1240PK 3/4" Inside Diameter
1" Outside Diameter
Black Nylon
Wire Loom Routing Clips
G.M. # 8917320, 3816659

25 Pcs.



















General Motors

Retainers Shield

JL-24PK	7/64" (2.80mm) Hole Size 25/64" Stem Length 7/32" Head Diameter .069 - .250" Panel Range Black Nylon Shield Retainers G.M. # 20729523	100 Pcs.		
5602PK	5/32" (4mm) Hole Size 7/16" Stem Length 23/64" Head Diameter .030 - .275" Panel Range Black Nylon Shield Retainers G.M. # 10063599	100 Pcs.		
8172PK	3/16" (4.50mm) Hole Size 21/32" Stem Length 7/16" Head Diameter .060 - .390" Panel Range Black Nylon Dash Panel Retainers AMC # 4006516 Ford # 388246A G.M. # 25016383, 20413107	50 Pcs.		
12028PK	13/64" (5mm) Hole Size 14mm Stem Length 9mm Head Diameter Black Nylon Bumper Cover Retainers G.M. # 24205245	50 Pcs.		
9528PK	13/64" (5mm) Hole Size 17.80mm Stem Length 11mm Head Diameter Black Nylon Rear Bumper Fascia Retainers G.M. # 1644290 Nissan # 01553-0075U	25 Pcs.		
1583PK	13/64" (5mm) Hole Size 3/4" Stem Length 19/32" Head Diameter .70 - .555" Panel Range Black Nylon Shroud Vent Grille To Panel Retainers G.M. # 20514862	50 Pcs.		
5618PK	15/64" (6mm) Hole Size 1/2" Stem Length 15/32" Head Diameter .035 - .285" Panel Range Black Nylon Shield Retainers G.M. # 20709017	50 Pcs.		
10427PK	15/64" (6mm) Hole Size 13mm Stem Length 9.50mm Head Diameter Black Nylon Body Side Moulding Retainers G.M. # 20455900	25 Pcs.		
11002PK	15/64" (6mm) Hole Size 20mm Stem Length 18mm Head Diameter Black Nylon Bumper & Fender Apron Retainers Ford # W711687-S300 G.M. # 11589181	25 Pcs.		

General Motors

Retainers Shield

10568PK	15/64" (6mm) Hole Size 33mm Stem Length 18mm Head Diameter Black Nylon Wheel Well Shield Retainers Ford # W709002, W709002-SAA G.M. # 11588950	25 Pcs.		
1410PK	1/4" (6.30mm) Hole Size 1/2" Stem Length 3/4" Head Diameter Black Nylon Mud Shield Retainers Chrysler # 3861577 Ford # 387258-S G.M. # 20032850	100 Pcs.		
1761PK	1/4" (6.30mm) Hole Size 21/32" Stem Length 11/16" Head Diameter .115 - .400" Panel Range Gray Nylon Shield Retainers Chrysler # 6030538 G.M. # 6270163, 480534	50 Pcs.		
5429PK	1/4" (6.30mm) Hole Size 21/32" Stem Length 11/16" Head Diameter .115 - .400" Panel Range Black Nylon Bumper & Fender Shield Retainers AMC # 4004569 Chrysler # 6031321, 3691590 Ford # 389358-S G.M. # 332364, 14093311, 20732399	100 Pcs.		
18346PK	1/4" (6.30mm) Hole Size 21/32" Stem Length 11/16" Head Diameter .115 - .400" Panel Range Gray Nylon Shield Retainers Chrysler # 6030538 G.M. # 6270163, 480534	50 Pcs.		
9311PK	1/4" (6.30mm) Hole Size 11/16" Stem Length 1/2" Head Diameter Black Nylon Rear Bumper Fascia Retainers G.M. # 22536642	50 Pcs.		
5506PK	1/4" (6.30mm) Hole Size 23/32" Stem Length 1/2" Head Diameter .110 - .460" Panel Range Black Nylon Trim Panel Retainers G.M. # 411700	50 Pcs.		
5625PK	1/4" (6.30mm) Hole Size 13/16" Stem Length 23/32" Head Diameter .095 - .540" Panel Range Black Nylon Fender & Bumper Shield Retainers AMC # 4004919 Chrysler # 6036007AA, 6502078, 6030441 Ford # 388577S, 389358S, W705589-S300 G.M. # 1605396, 11569768, 15958694	100 Pcs.		

18

General Motors

Retainers Shield

13218PK	1/4" (6.30mm) Hole Size 22mm Stem Length 23mm Head Diameter Tan Nylon Headliner Shield Retainers G.M. # 15944588	25 Pcs.		
9130PK	1/4" (6.30mm) Hole Size 1 1/16" Stem Length 23/32" Head Diameter .095 - .805" Panel Range Black Nylon Engine Splash Shield Retainers Chrysler # 6033082, 6033840 Ford # W709346-S300, 39001S G.M. # 10121502, 10077401	50 Pcs.		
12048PK	1/4" (6.30mm) Hole Size 27mm Stem Length 25.40mm Head Diameter Black Nylon Fender & Headliner Retainers G.M. # 15802005	25 Pcs.		
10366PK	1/4" (6.30mm) Hole Size 1 3/32" Stem Length 7/8" Head Diameter Black Nylon Splash Shield & Wheel Cover Retainers Chrysler # 6501916 G.M. # 22547243	50 Pcs.		
10434PK	1/4" (6.30mm) Hole Size 35mm Stem Length 18mm Head Diameter 10.50 - 26.60mm Panel Range Charcoal Gray Nylon Wheel Opening Moulding Retainers Ford # W705955-S300 G.M. # 10146315	50 Pcs.		
9345PK	1/4" (6.30mm) Hole Size 1 7/16" Stem Length 1" Head Diameter Black Nylon Shield Retainers G.M. # 14027471	25 Pcs.		
16398PK	1/4" (6.50mm) Hole Size 21mm Stem Length 25mm Head Diameter Black Nylon Headliner Retainers G.M. # 13475541	25 Pcs.		
1408PK	9/32" (7mm) Hole Size 9/16" Stem Length 13/32 x 1" Head Size Black Nylon Cowl Insulation Retainers Ford # 384051-S G.M. # 480534	25 Pcs.		

18

General Motors

Retainers Shield

1644PK	<p>9/32" (7mm) Hole Size 3/4" Stem Length 15/16" Head Diameter Natural Nylon Interior Trim Panel Retainers Chrysler # 6003423 G.M. # 2048248, 208824</p>	50 Pcs.		
5635PK	<p>9/32" (7mm) Hole Size 20mm Stem Length 25mm Head Diameter 2.56 - 12.96mm Panel Range Black Nylon Interior Trim Retainers Chrysler # 6506788 Ford # N802734S G.M. # 22718305</p>	50 Pcs.		
12014PK	<p>9/32" (7mm) Hole Size 23mm Stem Length 18mm Head Diameter Black Nylon Inside Fender Shield & Bumper Fascia Retainers G.M. # 94145515 Isuzu # 8941-455150</p>	25 Pcs.		
9374PK	<p>9/32" (7mm) Hole Size 15/16" Stem Length 25/32" Head Diameter Black Nylon Seat Back Shield Retainers G.M. # 20319841</p>	25 Pcs.		
9523PK	<p>9/32" (7mm) Hole Size 1 3/32" Stem Length 1 1/32" Head Diameter Black Nylon Headliner Retainers Ford # W710923-S300 G.M. # 10229437, 10242316</p>	25 Pcs.		
9132PK	<p>9/32" (7mm) Hole Size 1 11/64" Stem Length 3/4" Head Diameter .055 - 1.00" Panel Range Black Nylon Bumper Fascia Retainers Chrysler # 6503768 G.M. # 10185925</p>	25 Pcs.		
11023PK	<p>9/32" (7mm) Hole Size 30mm Stem Length 14mm Head Diameter 2.00 - 21.00mm Panel Range Black Nylon Headlight Trim & Lift Gate Moulding Retainers G.M. # 10185866</p>	25 Pcs.		
9376PK	<p>9/32" (7mm) Hole Size 33.50mm Stem Length 10mm Head Diameter Black Nylon Bumper Cover Retainers G.M.</p>	25 Pcs.		

18









General Motors

Retainers Shield

JL-33PK	5/16" (8mm) Hole Size 31/32" Stem Length 3/4" Head Diameter .145 - .530" Panel Range Black Nylon Trim Panel Retainers Chrysler # 6501301 G.M. # 21094146, 21110201	25 Pcs.		
8862BPK	5/16" (8mm) Hole Size 1 1/16" Stem Length 3/4" Head Diameter .090 - .815" Panel Range Black Nylon Shield Retainers G.M. # 15975244	25 Pcs.		
11869PK	5/16" (8mm) Hole Size 1 1/8" Stem Length 1" Head Diameter Gray Nylon Headliner Shield Retainers G.M. # 15006827	25 Pcs.		
12598PK	5/16" (8mm) Hole Size 32mm Stem Length 19mm Head Diameter Black Nylon Pillar Cover Retainers G.M. # 15588078	10 Pcs.		
9195PK	5/16" (8mm) Hole Size 1 7/16" Overall Length 3/4" Outside Diameter Washer Black Nylon Radiator Grille Retainers G.M. # 15672328	25 Pcs.		
11166PK	5/16" (8mm) Hole Size 37mm Stem Length 25mm Head Diameter Tan Nylon Headliner Retainers G.M. # 10444839	25 Pcs.		
10469PK	23/64" (9mm) Hole Size 20mm Stem Length 24mm Head Diameter 1.60 - 10.00mm Panel Range Black Nylon Front End Retainers Chrysler # 6505667-AA Ford # N811540-S, W705681-S300 G.M. # 22189414	25 Pcs.		
5710PK	3/8" (9.50mm) Hole Size 27/32" Stem Length 1" Head Diameter .115 - .565" Panel Range Black Nylon Radiator Apron Panel Retainers G.M. # 1619321	25 Pcs.		



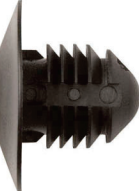

General Motors

Retainers Shield

9352PK	3/8" (9.50mm) Hole Size 57/64" Stem Length 7/8" Head Diameter Black Nylon Front End Stone Shield Retainers Chrysler # 6503221 G.M. # 22512276	25 Pcs.		
5648PK	25/64" (10mm) Hole Size 30mm Stem Length 22mm Head Diameter 1.19 - 20.20mm Panel Range Black Nylon Fascia Bumper Retainers Chrysler # 34202787 Ford # N804379-S G.M. # 1631564	50 Pcs.		
10672PK	13/32" (10.50mm) Hole Size 28mm Stem Length 21.50mm Head Diameter Black Nylon Bumper Fascia Retainers G.M. # 11518201	15 Pcs.		
9493PK	13/32" (10.50mm) Hole Size 1 7/16" Stem Length 1" Head Diameter Black Nylon Firewall Insulation Retainers AMC # 4001934 G.M. # 7642589	25 Pcs.		
9763PK	1/2" (12.50mm) Hole Size 15mm Stem Length 25mm Head Diameter 3.20 - 5.00mm Panel Range Black Nylon Bumper Fascia Retainers Chrysler # 65058686AA G.M. # 15056810	25 Pcs.		

18

Retainers Trim Panel

16392PK	8.25 x 17.50mm Slot Size 8.60mm Stem Length 16.00 x 22.00mm Head Size White Nylon Trim Retainers G.M. # 11603036	25 Pcs.		
16062PK	9mm Stem Length 12.00 x 22.00mm Top Head Size Black Nylon Headliner Retainers G.M. # 11547523, 11601777	15 Pcs.		

General Motors

Clips Hood Rod Prop

10084PK 7mm Rod Size
10mm Hole Size
Natural Nylon
Hood Prop Rod Clips
Chrysler # 5027550AB
G.M. # 15021761

25 Pcs.

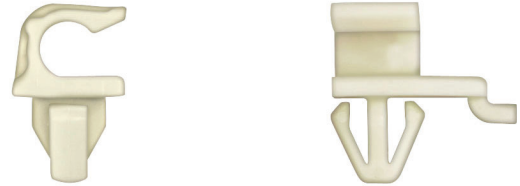

10082PK 5/16" Rod Size
Natural Nylon
Hood Prop Rod Clips
G.M. # 21097292

15 Pcs.

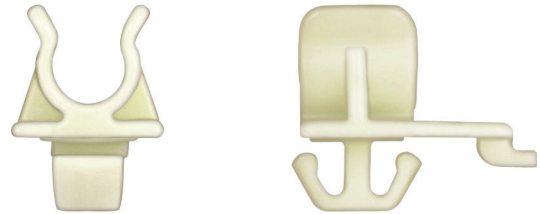

Retainers Hood Seal

1996PK 13/64" (5mm) Hole Size
11mm Stem Length
13mm Head Diameter
Black Nylon
Hood Seal Retaining Clips
G.M. # 94842841, 94849113
Toyota # 90467-08004, 90467-08011

50 Pcs.



9520PK 5/16" (8mm) Hole Size
21/32" Stem Length
5/8" Head Diameter
Black Nylon
Hood Seal Retainers
G.M. # 22567463

25 Pcs.



5995PK 5/16" (8mm) Hole Size
1 7/16" Stem Length
3/4" Head Diameter
.055 - 1.05" Panel Range
Black Nylon
Hood Seal Retainers
G.M. # 14074081, 15552345, 1699250

25 Pcs.



Retainers Hood Insulation

2167PK 1/4" (6.30mm) Hole Size
12.50mm Stem Length
30mm Head Diameter
Black Nylon
Hood Insulation Retainers
Chrysler # 6502842
G.M. # 21039129

50 Pcs.



1930PK 1/4" (6.30mm) Hole Size
3/4" Stem Length
1 5/8" Head Diameter
Black Nylon
Hood Insulation Clips
G.M. # 20064875

25 Pcs.



General Motors

Retainers Hood Insulation

5440PK

1/4" (6.30mm) Hole Size
3/4" Stem Length
2" Head Diameter
Black Nylon
Hood Insulation Retainers
G.M. # 3078511, 3977775

25 Pcs.



10393PK

9/32" (7mm) Hole Size
13mm Stem Length
40mm Head Diameter
Black Nylon
Hood Insulation Retainers
G.M. # 21039141, 15678493

25 Pcs.

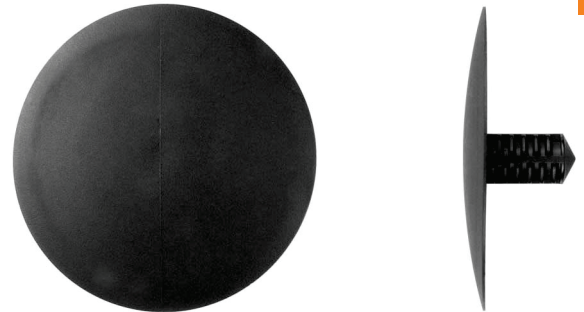

12172PK

9/32" (7mm) Hole Size
15mm Stem Length
30mm Head Diameter
Black Nylon
Hood Insulation Retainers
G.M. # 11571159

25 Pcs.



1929PK

9/32" (7mm) Hole Size
25mm Stem Length
35mm Head Diameter
Black Polypropylene
Hood Insulation Retainers
G.M. # 20030401

25 Pcs.

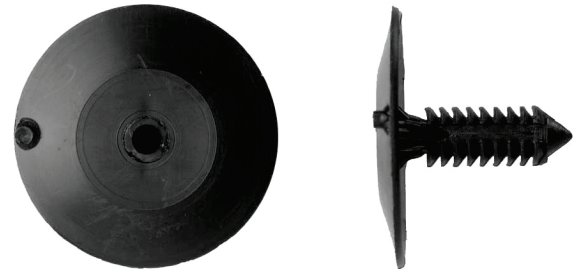

12072PK

9/32" (7.10mm) Hole Size
17mm Stem Length
28mm Head Diameter
Black Nylon
Hood Insulation Retainers
G.M. # 15989431



25 Pcs.





18

General Motors



Retainers Hood Insulation



15696PK	5/16" (8mm) Hole Size 16mm Stem Length 32mm Head Diameter Black Nylon Hood Insulation Retainers G.M. # 11611677	10 Pcs.		
----------------	--	----------------	--	---



Retainers Weatherstrip



9863PK	1/8" (3.30mm) Hole Size 13/32" Stem Length 3/8" Head Diameter Black Nylon Weatherstrip Retainers G.M. # 8731909, 4841194	100 Pcs.		
---------------	---	-----------------	--	---



18247PK	9/64" (3.50mm) Hole Size 7/16" Stem Length 13/32" Flange Diameter Black Nylon Weatherstrip Retainers G.M. # 4801268	100 Pcs.		
----------------	--	-----------------	--	---

10657PK	11/64" (4.20mm) Hole Size 12mm Stem Length 11mm Head Diameter Black Nylon Weatherstrip Retainers Chrysler # 6104908-AA G.M. # 20538173 Mercedes # 002-997-33-86	50 Pcs.		
----------------	--	----------------	--	---

1991PK	11/64" (4.50mm) Hole Size 12mm Stem Length 4.75 x 13.50mm Head Size Black Nylon Weatherstrip Retainers G.M. # 4876498	100 Pcs.		
---------------	--	-----------------	--	---

5605PK	3/16" (4.80mm) Hole Size 21/64" Stem Length 7/16" Head Diameter .080 - .200" Panel Range Black Nylon Weatherstrip Retainers G.M. # 10169777	25 Pcs.		
---------------	---	----------------	--	---

JL-32PK	3/16" (4.80mm) Hole Size 17/32" Stem Length 3/8" Head Diameter .125 - .310" Panel Range Black Nylon Weatherstrip Retainers G.M. # 2964547	25 Pcs.		
----------------	---	----------------	--	---

16451PK	13/64" (5mm) Hole Size 8mm Stem Length 6.50 x 14.00mm Head Size Natural Nylon Weatherstrip Retainers G.M. # 11611342	100 Pcs.		
----------------	---	-----------------	--	---





16448PK	13/64" (5mm) Hole Size 4.70 x 7.00mm Stem Size 6.50 x 14.00mm Top Head Size Green Nylon Door Weatherstrip Retainers G.M. # 11611664	25 Pcs.		
----------------	--	----------------	--	---

General Motors

Retainers Weatherstrip

2016PK	13/64" (5mm) Hole Size 10.50mm Stem Length 6.50 x 16.50mm Head Size White Nylon Weatherstrip Retainers Chrysler # 4696129 G.M. # 21077575	50 Pcs.		
10664PK	13/64" (5mm) Hole Size 10.50mm Stem Length 10.90mm Top Head Diameter Natural Nylon Weatherstrip Retainers G.M.	50 Pcs.		
JL-23PK	13/64" (5mm) Hole Size 11.50mm Stem Length 10mm Head Diameter .030 - .285" Panel Range Black Nylon Weatherstrip Retainers G.M. # 20699808	50 Pcs.		
5609PK	13/64" (5mm) Hole Size 5/8" Stem Length 19/32" Head Diameter .030 - .365" Panel Range Black Nylon Weatherstrip Retainers Chrysler # 4658673 G.M. # 10293674	50 Pcs.		
10974PK	13/64" (5mm) Hole Size 9mm Stem Length 5.00 x 15.00mm Head Size Natural Nylon Weatherstrip Retainers G.M. # 10283414, 10405030	100 Pcs.		
10462PK	15/64" (6mm) Hole Size 15.50mm Stem Length 12.60mm Head Diameter .80 - 8.00mm Panel Range Black Nylon Weatherstrip Retainers Ford # N811040-S G.M. # 10293193	50 Pcs.		
11906PK	9/32" (7.10mm) Hole Size 5/8" Stem Length 1/2" Head Diameter Black Nylon Weatherstrip Retainers G.M. # 390126-S	25 Pcs.		

Retainers Push Type

10425PK	13/64" (5mm) Hole Size 10mm Stem Length 7mm Flange Diameter Black Nylon Door Handle Attachment Push Type Retainers G.M. # 21077405	25 Pcs.		
9859PK	13/64" (5mm) Hole Size 10mm Stem Length 7mm Flange Diameter Black Nylon Door Handle Push Type Retainers G.M. # 21097229	25 Pcs.		

18

General Motors











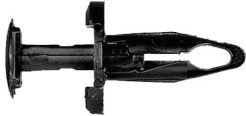

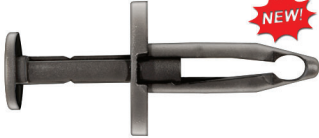

Retainers Push Type

1310PK	13/64" (5mm) Hole Size 15/32" Stem Length 3/8" Head Diameter Black Nylon Tail Light Push Type Retainers Chrysler # 6500787 G.M. # 16500308	25 Pcs.		
16084PK	7/32" (5.60mm) Hole Size 12.70mm Stem Length 9.50mm Head Size Black Nylon Body Side Moulding Push Type Retainers G.M. # 20363491	25 Pcs.		
9947PK	15/64" (6mm) Hole Size 14mm Stem Length 14mm Head Diameter Black Nylon Push Type Retainers G.M. # 21047094, 21110145	25 Pcs.		
9617PK	15/64" (6mm) Hole Size 16mm Stem Length 17mm Flange Diameter Black Nylon Radiator & Fender Push Type Retainers Chrysler # 6506008-AA Ford # W709176-S300 G.M. # 15149708	25 Pcs.		
9320PK	15/64" (6mm) Hole Size 23mm Stem Length 15mm Flange Diameter Black Nylon Push Type Fascia Retainers Chrysler # 4857108 Ford # N803709S G.M. # 15681408, 25642453	50 Pcs.		
17598PK	1/4" (6.30mm) Hole Size 13mm Stem Length 15mm Flange Diameter Black Nylon Push Type Retainers G.M. # 96057846 Hyundai # 86155-2200 Toyota # 90467-07041, 90467-07041-B2, 90467-07076-C0	10 Pcs.		
5675PK	1/4" (6.30mm) Hole Size 9/16" Stem Length 11/16" Flange Diameter Black Nylon Front Fender Mud Skirt & Liner Push Type Retainer AMC # 8934-201-621 AMC/Jeep # 6503454 Chrysler # 34201621, 6504090 Ford # E308-4A163CA G.M. # 14019205, 14019206	50 Pcs.		
1087PK	1/4" (6.30mm) Hole Size 5/8" Stem Length 11/16" Flange Diameter Black Nylon Push Type Retainers Chrysler # 6031390 G.M. # 472434	50 Pcs.		

18

General Motors

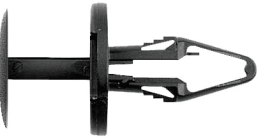
Retainers Push Type

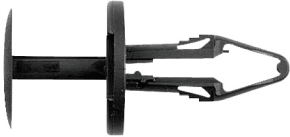
9559PK	<p>1/4" (6.30mm) Hole Size 3/4" Stem Length 19/32" Flange Diameter Black Nylon Wheel Moulding Push Type Retainers Chrysler # 6509103AA, 6509103-AA Ford # W705436-S300 G.M. # 21077123, 20730531</p>	25 Pcs.		
2045PK	<p>1/4" (6.30mm) Hole Size 13/16" Stem Length 11/16" Flange Diameter Black Nylon Push Type Retainers Chrysler # 6501925 Ford # F50C-9E728-AA G.M. # 10134407, 15990756</p>	25 Pcs.		
18221PK	<p>1/4" (6.30mm) Hole Size 7/8" Stem Length 11/16" Flange Diameter Black Nylon Body Push Type Retainers Chrysler # 34202672 Ford # N803362-S G.M. # 20510029</p>	25 Pcs.		
5935PK	<p>1/4" (6.30mm) Hole Size 7/8" Stem Length 1" Flange Diameter Black Nylon Splash Shield Push Type Retainers Chrysler # 55176248 Ford # 802781-S, W704340-S300, N802781-S G.M. # 14093088</p>	25 Pcs.		
9745PK	<p>1/4" (6.30mm) Hole Size 1 1/8" Stem Length 3/4" Flange Diameter Black Nylon Push Type Retainers G.M. # 3540858</p>	25 Pcs.		
10368PK	<p>1/4" (6.50mm) Hole Size 17.50mm Stem Length 18mm Flange Diameter 2.00 - 4.50mm Panel Range Black Nylon Push Type Retainers Chrysler # 6508863AA Ford # W713610-S300 G.M. # 11589289</p>	25 Pcs.		
10369PK	<p>1/4" (6.50mm) Hole Size 20mm Stem Length 18mm Flange Diameter 4.50 - 7.00mm Panel Range Black Nylon Push Type Retainers Chrysler # 6509049-AA Ford # W714040-S300 G.M. # 11589290</p>	50 Pcs.		
10367PK	<p>1/4" (6.50mm) Hole Size 22mm Stem Length 18mm Flange Diameter 7.00 - 9.50mm Panel Range Black Nylon Push Type Retainers Ford # W713331-S300 G.M. # 11589291</p>	25 Pcs.		

18











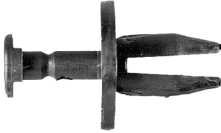

General Motors

Retainers Push Type

12283PK	1/4" (6.50mm) Hole Size 22mm Stem Length 18mm Flange Diameter Black Nylon With Sealer Cowl Vent Retainers G.M. # 95230842	15 Pcs.		
10450PK	9/32" (7mm) Hole Size 7.50mm Stem Length 18mm Flange Diameter Black Nylon Front Fender Liner Push Type Retainers G.M. # 88970767 Toyota # 90467-10183	10 Pcs.		
14996PK	9/32" (7mm) Hole Size 12mm Stem Length 16mm Head Diameter Black Nylon Liftgate & Garnish Moulding Push Type Retainers G.M. # 21035345	15 Pcs.		
10410PK	9/32" (7mm) Hole Size 14mm Stem Length 11mm Flange Diameter Black Nylon Radiator Grille Retainers G.M. # 96057847, 94847334 Suzuki # 09409-07313, 90467-07313 Toyota # 90467-07066, 90467-07066-J0	10 Pcs.		
13094PK	9/32" (7mm) Hole Size 14mm Stem Length 21mm Flange Diameter Black Nylon Headliner Push Type Retainers G.M. # 11547047	25 Pcs.		
9369PK	9/32" (7.10mm) Hole Size 7/8" Stem Length 11/16" Flange Diameter Black Nylon Exterior Body Push Type Retainers G.M. # 20590899	25 Pcs.		
10660PK	5/16" (8mm) Hole Size 9.30mm Stem Length 16mm Head Diameter Black Nylon Weatherstrip Retainers G.M.	50 Pcs.		
10421PK	5/16" (8mm) Hole Size 10mm Stem Length 15mm Head Diameter Natural Nylon With Sealer Radiator Grille Retainers G.M. # 94848834 Toyota # 62955-20020, 62955-12010	25 Pcs.		
18167PK	5/16" (8mm) Hole Size 15mm Stem Length 20mm Head Diameter Black Nylon Front Fender Retainers G.M. # 11546805	50 Pcs.		

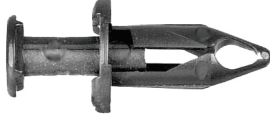
General Motors

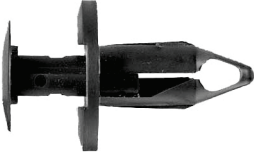
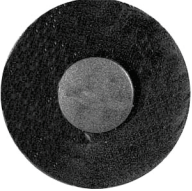
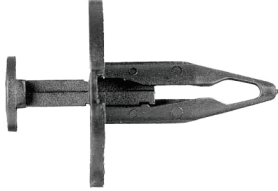
Retainers Push Type

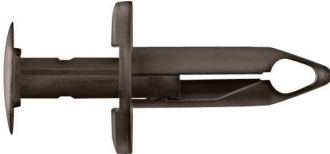
5676PK	5/16" (8mm) Hole Size 13.50mm Stem Length 17mm Flange Diameter Black Nylon Radiator Push Type Retainers Chrysler # 175720B010 Ford # 04388293 G.M. # 14071289, 14019226	25 Pcs.		
12724PK	5/16" (8mm) Hole Size 15mm Stem Length 15.00 x 19.00mm Flange Black Nylon Grille Attachment Retainers G.M. # 14032200	25 Pcs.		
15359PK	5/16" (8mm) Hole Size 19/32" Stem Length 21/32" Flange Diameter Black Nylon Push Type Retainer G.M. # 14039420	25 Pcs.		
10370PK	5/16" (8mm) Hole Size 16mm Stem Length 19mm Flange Diameter 5.00 - 7.00mm Panel Range Black Nylon Push Type Retainers Chrysler # 5116530AA G.M. # 15296830	25 Pcs.		
1861PK	5/16" (8mm) Hole Size 20mm Stem Length 15mm Flange Diameter Black Nylon Rocker Panel Retainers Chrysler # 6504555 Ford # F3LB-14K056-AA G.M. # 21075686	25 Pcs.		
1860PK	5/16" (8mm) Hole Size 20mm Stem Length 20mm Flange Diameter Black Nylon Air Baffle Push Type Retainers Chrysler # 6503598 Ford # N807389S, 807389S G.M. # 21030249, 15969147	25 Pcs.		
5940PK	5/16" (8mm) Hole Size 7/8" Stem Length 1" Flange Diameter Black Nylon Splash Shield Push Type Retainers Ford # N804614S, N803934-S G.M. # 20570245, 20635065	25 Pcs.		
10504PK	5/16" (8mm) Hole Size 26mm Stem Length 20mm Flange Diameter Black Nylon Fender Shield Push Type Retainers Ford # W708530-S300 G.M. # 11518017	15 Pcs.		

18

General Motors

Retainers Push Type

10669PK	5/16" (8mm) Hole Size 27mm Stem Length 16.50mm Flange Diameter Black Nylon Rear Wheel Apron & Bumper Push Type Retainers Chrysler # 04596357AA G.M. # 15994165	25 Pcs.		
9357PK	5/16" (8mm) Hole Size 28mm Stem Length 20mm Flange Diameter Black Nylon Bumper Fascia Retainers G.M. # 21095797	25 Pcs.		
9184PK	5/16" (8mm) Hole Size 29mm Stem Length 15mm Head Diameter Black Nylon Rocker Moulding Push Type Retainers G.M. # 10207146, 21077323	25 Pcs.		
10673PK	5/16" (8mm) Hole Size 30mm Stem Length 25mm Flange Diameter Black Nylon Bumper Cover Retainers G.M. # 11561874 Nissan # 622A2-9E000A, 622A2-9E000	10 Pcs.		
10239PK	21/64" (8.30mm) Hole Size 14mm Stem Length 19mm Flange Diameter 2.70 - 5.30mm Panel Range Black Nylon Push Type Retainers Ford # W715537-S300 G.M. # 11609417	50 Pcs.		
13089PK	21/64" (8.50mm) Hole Size 12mm Stem Length 20mm Flange Diameter Black Nylon Front Fender & Body Side Liner Push Type Retainers G.M. # 11612035	25 Pcs.		
10371PK	21/64" (8.50mm) Hole Size 20.50mm Stem Length 20mm Flange Diameter 2.00 - 4.50mm Panel Range Black Nylon Push Type Retainers G.M. # 11589292	25 Pcs.		
10374PK	21/64" (8.50mm) Hole Size 22mm Stem Length 20mm Flange Diameter 4.50 - 7.00mm Panel Range Black Nylon Push Type Retainers Ford # W712196S300 G.M. # 11589293	25 Pcs.		

18

General Motors

Retainers Push Type

10372PK	21/64" (8.50mm) Hole Size 24mm Stem Length 20mm Flange Diameter 7.00 - 10.00mm Panel Range Black Nylon Push Type Retainers G.M. # 11589294	25 Pcs.		
13234PK	23/64" (9mm) Hole Size 13mm Stem Length 24.50mm Flange Diameter Black Nylon Sight Shield & Trim Push Type Retainers G.M. # 10382313	10 Pcs.		
10247PK	23/64" (9mm) Hole Size 21mm Stem Length 20mm Flange Diameter Black Nylon Rear Bumper Cover Push Type Retainers G.M. # 15153415	25 Pcs.		
9327PK	23/64" (9mm) Hole Size 28mm Stem Length 18mm Flange Diameter Black Nylon Rear Bumper Cover Push Type Retainers G.M. # 94858560 Toyota # 52161-16010, 52161-02020, 52161-02030	4 Pcs.		
5677PK	3/8" (9.50mm) Hole Size 1 1/16" Stem Length 1" Flange Diameter Black Nylon Fascia Blind Rivets Chrysler # 55074801 G.M. # 14045480	25 Pcs.		
9935PK	3/8" (9.50mm) Hole Size 18mm Stem Length 17mm Flange Diameter Black Nylon Front Bumper Fascia Push Type Retainers G.M. # 1636632, 20687704	25 Pcs.		
10375PK	3/8" (9.50mm) Hole Size 20mm Stem Length 18mm Flange Diameter 3.00 - 5.80mm Panel Range Black Nylon Push Type Retainers Chrysler # 6508712AA G.M. # 11561368	25 Pcs.		
9370PK	3/8" (9.50mm) Hole Size 23mm Stem Length 18mm Flange Diameter Black Nylon Front Bumper Fascia Retainers G.M. # 15993201, 10157900, 11517803	25 Pcs.		

18

General Motors

Retainers Push Type

10674PK	3/8" (9.50mm) Hole Size 15/16" Stem Length 1" Flange Diameter 5/32" Shoulder Length Black Nylon Rear Bumper Fascia Retainers G.M. # 22587036	25 Pcs.		
11165PK	25/64" (10mm) Hole Size 12mm Stem Length 26mm Flange Diameter Black Nylon Fuel Tank Shield Push Type Retainers G.M. # 22718369	25 Pcs.		
9687PK	25/64" (10mm) Hole Size 13.50mm Stem Length 20mm Flange Diameter Black Nylon Radiator Grille Push Type Retainers Chrysler # 6509761-AA G.M. # 24512415	15 Pcs.		
15003PK	25/64" (10mm) Hole Size 18mm Stem Length 27mm Flange Diameter Black Nylon Radiator Support Push Type Retainers G.M. # 25695687	15 Pcs.		
2026PK	25/64" (10mm) Hole Size 20mm Stem Length 20mm Flange Diameter Black Nylon Front Bumper Fascia Retainers G.M. # 10108746	25 Pcs.		
10502PK	25/64" (10mm) Hole Size 26mm Stem Length 18mm Flange Diameter Black Nylon Bumper Cover Push Type Retainers G.M. # 11519444, 11517803, 4857753AA	25 Pcs.		
11257PK	25/64" (10mm) Hole Size 36mm Stem Length 24.50mm Top Flange Diameter Natural Nylon Front Bumper Deflector Retainers G.M. # 10426555	15 Pcs.		
10377PK	13/32" (10.50mm) Hole Size 20mm Stem Length 25mm Flange Diameter 3.00 - 6mm Panel Range Black Nylon Push Type Retainers Chrysler # 5GUU9K11BA Ford # W712665-S300 G.M. # 11589295	15 Pcs.		

General Motors

Retainers Push Type

10378PK 13/32" (10.50mm) Hole Size
23mm Stem Length
25mm Flange Diameter
6.00 - 9.00mm Panel Range
Black Nylon
Push Type Retainers
G.M. # 11589296

15 Pcs.

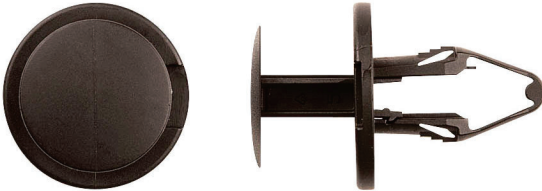

9592PK 7/16" (11mm) Hole Size
2" Stem Length
1 3/16" Flange Diameter
Black Nylon Fascia
Push Type Retainers
G.M. # 214077131
Nissan # 01553-0161U

10 Pcs.



5672PK 1/2" (12.70mm) Hole Size
3/4" Stem Length
1" Flange Diameter
1/8" Shoulder Length
Black Nylon Fascia
Push Type Retainers
G.M. # 5973400

25 Pcs.

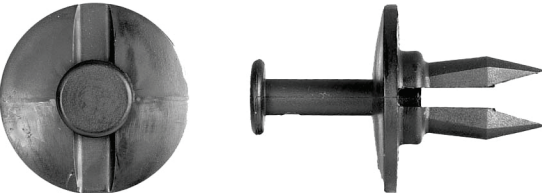

1234PK 1/2" (12.70mm) Hole Size
25/32" Stem Length
7/8" Flange Diameter
5/32" Shoulder Length
Blue Nylon Fascia
Push Type Retainers
G.M. # 5973823

25 Pcs.

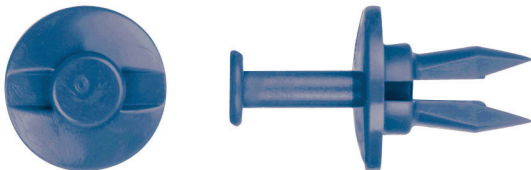

10714PK 1/2" (12.70mm) Hole Size
15/16" Stem Length
1" Flange Diameter
7/64" Shoulder Length
Black Nylon
Plastic Cover On Engine
Push Type Retainers
G.M. # 14101262

25 Pcs.

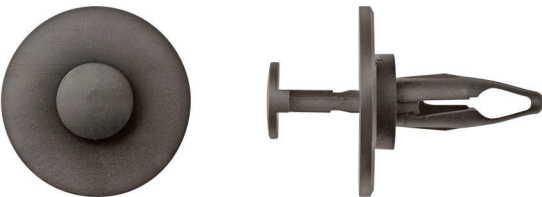

11112PK 1/2" (12.70mm) Hole Size
15/16" Stem Length
1 1/8 x 1 3/4" Flange Size
Black Nylon
Front Bumper Fascia
Push Type Retainers
G.M. # 22659122

10 Pcs.

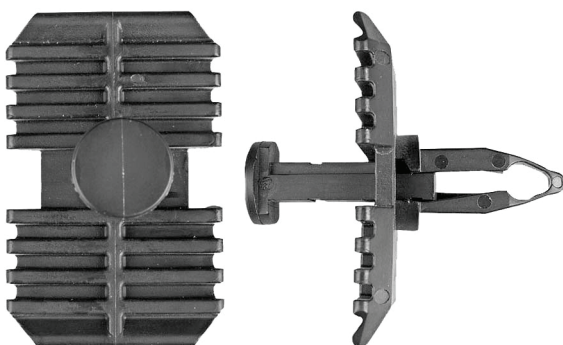

5680PK 1/2" (12.70mm) Hole Size
1" Stem Length
1" Flange Diameter
3mm Shoulder Length
Black Nylon Fascia
Push Type Retainers
G.M. # 22535007

25 Pcs.

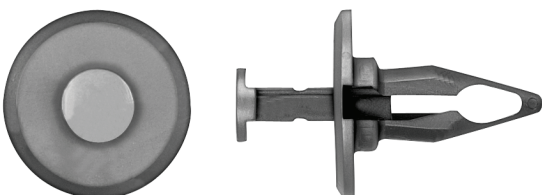

18

General Motors

Retainers Push Type

1448PK 1/2" (12.70mm) Hole Size
1 3/64" Stem Length
7/8" Flange Diameter
3/16" Shoulder Length
Black Nylon
Bumper Fascia Retainers
G.M. # 14103461

25 Pcs.

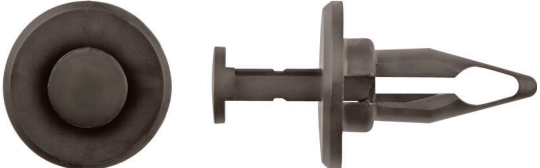

1447PK 1/2" (12.70mm) Hole Size
1 1/8" Stem Length
1" Flange Diameter
1/4" Shoulder Length
Black Nylon Bumper Fascia
Push Type Retainers
Chrysler # 55022134
G.M. # 10077283, 14103438

25 Pcs.

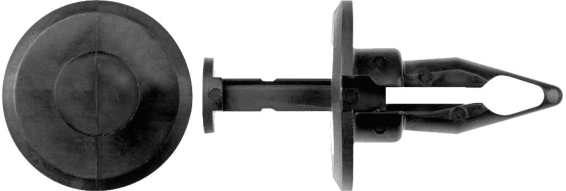

10382PK 1/2" (12.70mm) Hole Size
1 5/8" Stem Length
1" Flange Diameter
9/64" Shoulder Length
Black Nylon License Plate
Push Type Retainers
G.M. # 15959832

5 Pcs.

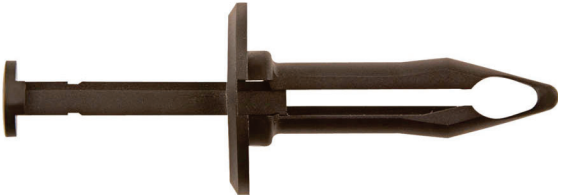

15029PK 1/2" (12.70mm) Hole Size
44.50mm Stem Length
25.40mm Flange Diameter
Gray Nylon Front License Bracket
Push Type Retainers
G.M. # 15959833

5 Pcs.



10535PK 19/32" (15mm) Hole Size
13mm Stem Length
22mm Flange Diameter
Black Nylon Rocker Moulding
Push Type Retainers
G.M. # 5480772

10 Pcs.



9695PK 13mm Stem Length
28mm Flange Diameter
Black Nylon
Front Air Deflector Grommets
Use With # 9694
G.M. # 15733970

25 Pcs.



9694PK 24mm Stem Length
30mm Flange Diameter
Black Nylon
Front Air Deflector Retainers
Use With # 9695
G.M. # 15733971



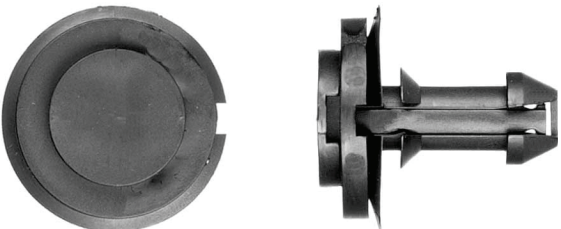











15 Pcs.

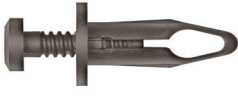

18

General Motors

Retainers Phillips Screw

1597PK	15/64" (6mm) Hole Size 11mm Stem Length 15mm Flange Diameter Black Nylon Phillips Screw Retainers G.M. # 30012018 Honda # 90684-SA5-0030, 90684-SA5-003 Isuzu # 874-298-1190, 8942981190 Nissan # 10998-30880	25 Pcs.		
2028PK	15/64" (6mm) Hole Size 16mm Stem Length 14mm Flange Diameter Black Nylon Engine Splash Phillips Screw Retainers G.M. # 94051993 Nissan # 66860-01W01	25 Pcs.		
11910PK	15/64" (6mm) Hole Size 17mm Stem Length 12mm Head Diameter Black Nylon Fender & Rocker Phillips Screw Retainer G.M. # 255657634	25 Pcs.		
9783PK	15/64" (6mm) Hole Size 20mm Stem Length 11mm Flange Diameter Black Nylon Rocker Panel Phillips Screw Retainers G.M. # 10246149, 22657634	25 Pcs.		
12472PK	1/4" (6.30mm) Hole Size 14mm Stem Length 15mm Flange Diameter Black Nylon Fender Liner Phillips Screw Retainers G.M. # 94530438 Ford # B04068865A96	25 Pcs.		
9508PK	1/4" (6.30mm) Hole Size 11/16" Stem Length 11/16" Flange Size Black Nylon Phillips Screw Retainers Ford # N808147S G.M. # 10139822, 25680782	25 Pcs.		
9968PK	1/4" (6.30mm) Hole Size 29/32" Stem Length 5/8" Flange Diameter Black Nylon Phillips Screw Retainers G.M. # 20664091 Ford # N803946S Chrysler # 6502871 Mercedes # 000-9941-52-40	50 Pcs.		
9067PK	1/4" (6.30mm) Hole Size 29/32" Stem Length 11/16" Flange Diameter Black Nylon Radiator Shroud Phillips Screw Retainers Chrysler # 6502790, 4638136 Ford # N804570S G.M. # 15773445, 20452072, 22538004, 20664092	25 Pcs.		

18

General Motors

Retainers Phillips Screw

1612PK	9/32" (7mm) Hole Size 9mm Stem Length 14.00 x 22.00mm Flange Size Black Nylon Phillips Screw Retainers G.M. # 94221150 Isuzu # 8942211500 Nissan # 63844-D0100	25 Pcs.		
10716PK	9/32" (7mm) Hole Size 9mm Stem Length 20mm Flange Diameter Black Nylon Garnish Moulding Phillips Screw Retainers G.M. # 88970494, 88973676 Toyota # 90467-07168, 90467-07168-C1	15 Pcs.		
10413PK	9/32" (7mm) Hole Size 9mm Stem Length 20mm Flange Diameter Black Nylon Quarter Panel Phillips Screw Retainers G.M. # 96064506 Suzuki # 09409-07303-5ES Toyota # 90467-07044	10 Pcs.		
2015PK	9/32" (7mm) Hole Size 11mm Stem Length 14mm Flange Diameter Black Nylon Phillips Screw Retainers G.M. # 94198687 Honda # 90657-SA6-0030, 90657-SA6-003 Mazda # N304-13-356-A	25 Pcs.		
1603PK	9/32" (7mm) Hole Size 12mm Stem Length 15mm Flange Diameter Black Nylon Phillips Screw Retainers G.M. # 20426301 Mazda # 9926-50-625 Toyota # 90467-06017, 90467-06017-20, 90467-06017-41, 90467-06017-C0	15 Pcs.		
10614PK	9/32" (7mm) Hole Size 23mm Stem Length 14mm Flange Diameter Black Nylon Phillips Screw Retainers G.M. # 15014352	15 Pcs.		
11918PK	9/32" (7mm) Hole Size 1 13/64" Stem Length 1/2" Head Diameter Black Nylon Push Type Retainers Chrysler # 4696488 Ford # N805026S G.M. # 10195515	25 Pcs.		
10523PK	5/16" (8mm) Hole Size 14mm Stem Length 14.00 x 26.00mm Flange Size Black Nylon Front Bumper Phillips Screw Retainers G.M. # 12337831	50 Pcs.		

18

General Motors



Retainers Phillips Screw



1265PK	5/16" (8mm) Hole Size 18mm Stem Length 17mm Flange Diameter Black Nylon Phillips Screw Retainers G.M. # 20451119 Nissan # 63844-01A99	25 Pcs.		
1446PK	5/16" (8mm) Hole Size 13/16" Stem Length 19/32 Flange Diameter Black Nylon Phillips Screw Retainers Chrysler # 6503163 G.M. # 10053182	25 Pcs.		
2163PK	5/16" (8mm) Hole Size 21mm Stem Length 20mm Flange Diameter Black Nylon Phillips Screw Retainers Acura # 90505-SL0-003 Chrysler # MB888869 G.M. # 9485236 Toyota # 90467-08155	5 Pcs.		
12916PK	23/64" (9mm) Hole Size 12mm Stem Length 16mm Flange Diameter Black Nylon Bumper Phillips Screw Retainers G.M. # 30008324 Suzuki # 09409-07325	15 Pcs.		
9202PK	25/64" (10mm) Hole Size 15mm Stem Length 20mm Flange Diameter Black Nylon Front & Rear Bumper Phillips Screw Retainers Acura # 91503-SP0-003 BMW # 07-13-0-702-966 G.M. # 94530623	15 Pcs.		
11138PK	13/32" (10.30mm) Hole Size 1" Stem Length 27/32" Flange Diameter Black Nylon Phillips Screw Retainers Ford # W708325-S300 G.M. # 11561353, 15672330, 15956470	25 Pcs.		
1730PK	15/32" (12mm) Hole Size 25mm Stem Length 21mm Flange Diameter 3mm Shoulder Length Black Nylon Rear Fascia Phillips Screw Retainers Chrysler # 6502625 G.M. # 10140480	25 Pcs.		
10540PK	9.00 - 13.00mm Hole Size 15mm Stem Length 19.00 x 30.00mm Flange Size Black & Gray Nylon Radiator Grille Retainers G.M. # 15764320, 15025531	10 Pcs.		

18

General Motors

Retainers Slotted Screw

10608PK	25mm Width 34mm Length Black Nylon Front Fender & Bumper Cover Clips Use With # 10609 G.M. # 19183888 Toyota # 53879-58010, 53879-02070	10 Pcs.		
----------------	--	----------------	--	---

10609PK	25mm Stem Length 15mm Head Diameter Black Nylon Front Fender & Bumper Cover Pins Use With # 10608 G.M. # 19183917 Toyota # 47749-58010	10 Pcs.		
----------------	--	----------------	--	---

Retainers Torx Screw

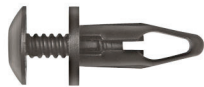
11234PK	15/64" (6mm) Hole Size 18mm Stem Length 11mm Flange Diameter Black Nylon Torx Screw Type Retainers Chrysler # 55075139 Ford # W713134-S300 G.M. # 10089262, 21042098	25 Pcs.		
----------------	---	----------------	--	---

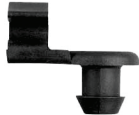

Clips Door Rod End

9437PK	5/32" Rod Size 15/64" Hole Size Left Hand Side Black Nylon Door Lock Rod Clips G.M. # 20582532, 20633148	25 Pcs.		
---------------	---	----------------	---	--

9438PK	5/32" Rod Size 15/64" Hole Size Right Hand Side Natural Nylon Door Lock Rod Clips G.M. # 20582533, 20633149	25 Pcs.		
---------------	--	----------------	--	---

9439PK	3/16" Rod Size Natural Nylon Tailgate Lock Rod Clips G.M. # 15545178, 14037239	10 Pcs.		
---------------	---	----------------	--	---

1249PK	5/32" Rod Size 15/64" Hole Size Right Hand Side Red Nylon Door Lock Rod Clips Chrysler # 3454220, 4658676 G.M. # 88981031	50 Pcs.		
---------------	---	----------------	--	---

1250PK	5/32" Rod Size 15/64" Hole Size Left Hand Side Green Nylon Door Lock Rod Clips Chrysler # 3454221, 4658677 G.M. # 8898130	50 Pcs.		
---------------	---	----------------	--	---

General Motors

Clips Door Rod End

9725PK 5/32" Rod Size
17/64" Hole Size
Right Hand Side
Natural Nylon
Door Rod & Hood Clips
AMC # 4003672
Chrysler # 2945108, 4658676
Ford # N805350S
G.M. # 16627328

20 Pcs.



9726PK 5/32" Rod Size
17/64" Hole Size
Left Hand Side
Black Nylon
Door Rod & Hood Clips
AMC # 4003673
Chrysler # 2945109, 4658677
Ford # N804344S, D2VZ-652195A
G.M. # 9815325, 16607593

50 Pcs.



9960PK 5/32" Rod Size
15/64" Hole Size
Left Hand Side
Black Nylon
Door Lock Rod Clips
Chrysler # 5257479, 4658677
G.M. # 16630689

25 Pcs.



9959PK 13/64" Rod Size
15/64" Hole Size
Right Hand Side
Natural Nylon
Door Lock Rod Clips
Chrysler # 5257478, 4658676
G.M. # 16630688

25 Pcs.



9731PK 4mm Rod Size
6mm Hole Size
Yellow Nylon
Door Lock Rod Clips
G.M. # 16606936, 16633853

100 Pcs.



1083PK Door Lock
Rod End Clips
G.M. # 4234830, 12337868

25 Pcs.

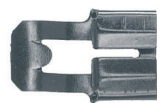

Clips Tailgate Lock Rod End

9981PK 10-24 Rod Size
2mm Panel Range
8mm Hole Size
Yellow Nylon
Door Lock & Tailgate Rod Clips
Ford # F65Z-1521952-AA,
F7DZ-7421952-AA
G.M. # 16629990, 16675980

15 Pcs.

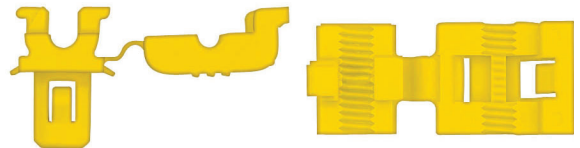

16391PK 10-24 Rod Size
2mm Panel Range
8mm Hole Size
Gray Nylon
Door Lock & Tailgate Rod Clips
Ford # F65Z-1521952-AA,
F7DZ-7421952-AA
G.M. # 16629990, 16675980, 16640343

15 Pcs.

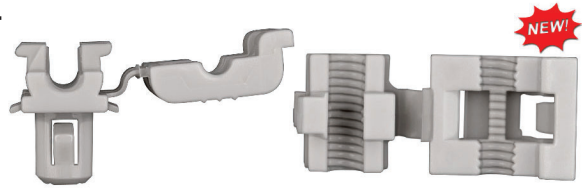

18

General Motors











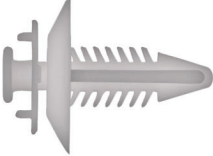

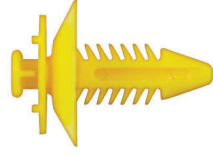

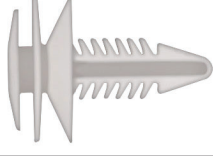
Retainers Door Trim Panel

15985PK	15/64" (6mm) Hole Size 9mm Stem Length 10mm Top Head Diameter White Nylon Door Panel Retainers G.M. # 11602522, 11603260	25 Pcs.		
9582PK	15/64" (6mm) Hole Size 10mm Stem Length 10mm Top Head Diameter White Nylon Door Trim Panel Retainers G.M. # 90560163	25 Pcs.		
9861PK	15/64" (6mm) Hole Size 24mm Stem Length 18mm Top Head Diameter White Nylon Door Trim Panel Retainers G.M. # 10285935	50 Pcs.		
16311PK	1/4" (6.50mm) Hole Size 9.30mm Stem Length 15mm Flange White Nylon With Sealer Interior Door Trim & Exterior Moulding Retainers G.M. # 11610700	15 Pcs.		
9860PK	1/4" (6.30mm) Hole Size 13mm Stem Length 18mm Head Diameter White Nylon Door Trim Panel Retainers G.M. # 10287971	50 Pcs.		
10399PK	1/4" (6.30mm) Hole Size 3/4" Stem Length 15/16" Top Head Diameter Natural Nylon Door Trim Panel Retainers G.M. # 20480475	50 Pcs.		
2029PK	1/4" (6.30mm) Hole Size 16.30mm Stem Length 14.30mm Head Diameter White Nylon Door Trim Panel Push Type Retainers G.M. # 15960325	50 Pcs.		
5264PK	1/4" (6.30mm) Hole Size 29/32" Stem Length 29/32" Top Head Diameter Natural Nylon Door Trim Panel Retainers G.M. # 3065575, 16656935X	50 Pcs.		
1646PK	1/4" (6.50mm) Hole Size 21mm Stem Length 6.30 x 11.50mm Top Head Size Natural Nylon Door Trim Panel Retainers G.M. # 15545202	50 Pcs.		

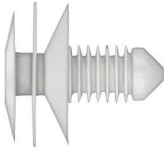
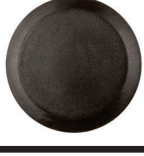
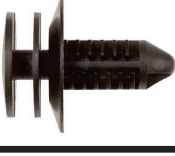
18

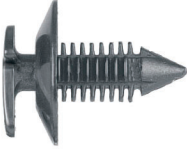
General Motors



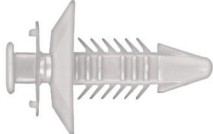









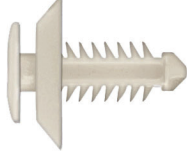

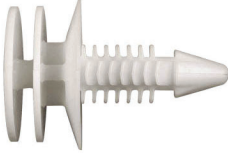

Retainers Door Trim Panel

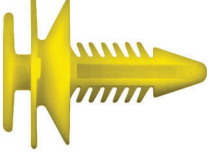
4020PK	1/4" (6.50mm) Hole Size 21mm Stem Length 6.30 x 11.50mm Top Head Size Natural Nylon Door Trim Panel Retainers G.M. # 20421800, 15600382	25 Pcs.		
9349PK	1/4" (6.50mm) Hole Size 21mm Stem Length 6.30 x 11.70mm Top Head Size Yellow Nylon Door Trim Panel Retainers G.M. # 15588024, 15596301	25 Pcs.		
9242PK	1/4" (6.50mm) Hole Size 21mm Stem Length 17mm Head Diameter Natural Nylon Door Trim Panel Retainers G.M. # 12337920, 20374473	50 Pcs.		
10543PK	9/32" (7mm) Hole Size 14mm Stem Length 18mm Top Head Diameter Yellow Nylon Door Garnish Moulding & Pillar Trim Panel Retainers G.M. # 10408480	50 Pcs.		
592PK	9/32" (7mm) Hole Size 14.80mm Stem Length 17.60mm Head Diameter Natural Nylon Door Trim Panel Retainers G.M. # 2064891, 9818648, 9883583	50 Pcs.		
2017PK	9/32" (7mm) Hole Size 16mm Stem Length 14mm Top Head Diameter Black Nylon Door Trim Panel Retainers G.M. # 15638413, 15963179	50 Pcs.		
9373PK	9/32" (7mm) Hole Size 18mm Stem Length 13mm Head Diameter Black Nylon Door Trim Panel Retainers AMC # 4005099 Chrysler # 6033862 G.M. # 796255 Navistar # 0501094C1	25 Pcs.		
1024PK	9/32" (7mm) Hole Size 18mm Stem Length 20mm Top Head Diameter Natural Nylon Door Trim Panel Retainers AMC # 4005470 Chrysler # 6003349 G.M. # 9685057 V.W. # N98905101	25 Pcs.		
9339PK	9/32" (7mm) Hole Size 19mm Stem Length 7.00 x 12.50mm Top Head Size White Nylon Door Trim Panel Retainers G.M. # 15612948, 15607165	25 Pcs.		

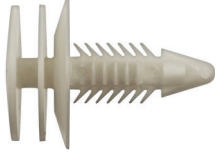
18



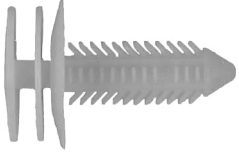







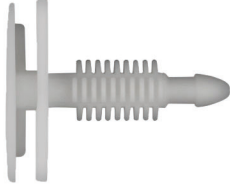

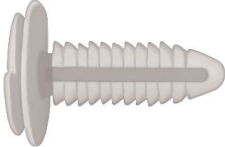

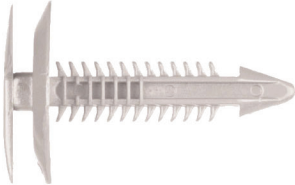

General Motors

Retainers Door Trim Panel

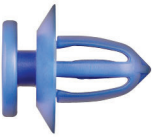
9224PK	9/32" (7mm) Hole Size 19mm Stem Length 13.20mm Top Head Diameter Natural Nylon Door Trim Panel Retainers Ford # W707741-S300 G.M. # 21042045, 21042053, 21042058, 21042104	50 Pcs.		
1558PK	9/32" (7mm) Hole Size 19mm Stem Length 13.30mm Top Head Diameter Natural Nylon Door Trim Panel Retainers Ford # N802900 G.M. # 21042958	25 Pcs.		
10653PK	9/32" (7mm) Hole Size 20mm Stem Length 7.00 x 12.50mm Top Head Size Natural Nylon Door Trim Panel Retainers G.M. # 15953247	50 Pcs.		
10520PK	9/32" (7mm) Hole Size 20.60mm Stem Length 18mm Top Head Diameter White Nylon Door Trim Panel Retainers G.M. # 10305191	50 Pcs.		
10398PK	9/32" (7mm) Hole Size 21mm Stem Length 16mm Top Head Diameter Yellow Nylon Door Trim Panel Retainers G.M. # 20734005	50 Pcs.		
12504PK	9/32" (7mm) Hole Size 21mm Stem Length 18mm Top Head Diameter White Nylon Door Trim Panel Retainer G.M. # 15986673	50 Pcs.		
10403PK	9/32" (7mm) Hole Size 22mm Stem Length 19mm Head Diameter Black Nylon Door Trim Panel Retainers G.M. # 25601491	50 Pcs.		
1807PK	9/32" (7mm) Hole Size 24mm Stem Length 18mm Top Head Diameter White Nylon Door Trim Panel Retainers G.M. # 10153057	25 Pcs.		
10495PK	9/32" (7mm) Hole Size 24mm Stem Length 18mm Top Head Diameter Green Nylon Door Trim Panel Retainers G.M. # 11588863	25 Pcs.		

General Motors













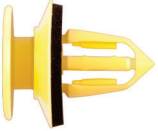

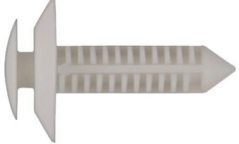

Retainers Door Trim Panel

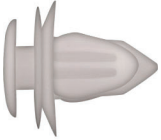
1648PK	9/32" (7mm) Hole Size 24mm Stem Length 20mm Top Head Diameter White Nylon Door Trim Panel Retainers Ford # 387496-S G.M. # 12084605	25 Pcs.		
1716PK	9/32" (7mm) Hole Size 25mm Stem Length 17mm Top Head Diameter Natural Nylon Door Trim Panel Retainers G.M. # 363137	100 Pcs.		
9502PK	9/32" (7mm) Hole Size 27mm Stem Length 22mm Top Head Diameter White Nylon Door Trim Panel Retainers G.M. # 20451401	25 Pcs.		
11041PK	9/32" (7mm) Hole Size 1 5/32" Stem Length 1/2" Top Head Diameter Natural Nylon Door Trim Panel Retainers G.M. # 15694099	15 Pcs.		
9368PK	9/32" (7mm) Hole Size 32mm Stem Length 20mm Top Head Diameter Natural Nylon Door Trim Panel Retainers G.M. # 10126901	50 Pcs.		
12044PK	5/16" (8mm) Hole Size 13mm Stem Length 13mm Top Head Diameter Blue Nylon Door Trim Panel Retainers G.M. # 132522118	25 Pcs.		
10703PK	5/16" (8mm) Hole Size 14mm Stem Length 13mm Top Head Diameter White Nylon Door Trim Panel Retainers G.M. # 90321122	50 Pcs.		
12844PK	5/16" (8mm) Hole Size 14mm Stem Length 13mm Top Head Diameter Gray Nylon Door Trim Panel Retainers G.M. # 11610605	25 Pcs.		
16408PK	5/16" (8mm) Hole Size 14mm Stem Length 15mm Top Head Size Yellow Nylon With Sealer Trim Panel Retainers G.M. # 11546588, 11547577	15 Pcs.		

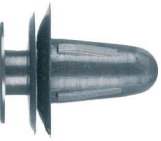
18

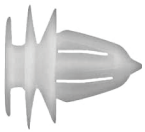



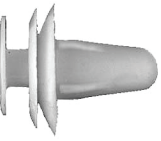





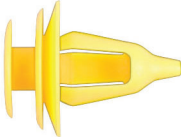

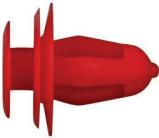

General Motors

Retainers Door Trim Panel

12043PK	5/16" (8mm) Hole Size 14mm Stem Length 17mm Head Diameter Green Nylon Door Trim Panel Retainers G.M. # 13252119	25 Pcs.		
11961PK	5/16" (8mm) Hole Size 15mm Stem Length 17mm Head Diameter Yellow Nylon Door Trim Panel Retainers G.M. # 11610606, 11546954, 11547602	25 Pcs.		
1742PK	5/16" (8mm) Hole Size 1" Stem Length 1/2" Top Head Diameter Natural Nylon Door Trim Panel Retainers AMC # 893202-599, 8934-202-599 Ford # N805612-S100, N805612-S G.M. # 10143422	50 Pcs.		
12894PK	5/16" (8mm) Hole Size 32mm Stem Length 19mm Head Diameter Green Nylon With Sealer Door Trim Panel Retainers G.M. # 25707329	10 Pcs.		
12828PK	21/64" (8.50mm) Hole Size 14mm Stem Length 13mm Top Head Diameter White Nylon Door Trim Panel Retainers G.M. # 94858299, 94178705 Toyota # 90467-10161, 90467-A0006	25 Pcs.		
1588PK	21/64" (8.50mm) Hole Size 14mm Stem Length 13mm Top Head Diameter Black Nylon Door Trim Panel Retainers G.M. # 95005064 Toyota # 67771-01010	25 Pcs.		
10744PK	23/64" (9mm) Hole Size 10mm Stem Length 13mm Head Diameter Natural Nylon Trim Panel Retainers G.M. # 94530565 Hyundai # 82315-38000	25 Pcs.		
10748PK	23/64" (9mm) Hole Size 13mm Stem Length 13mm Top Head Diameter White Nylon Door Panel & Rocker Moulding Clips G.M. # 88970656 Toyota # 67771-12080	15 Pcs.		
9081PK	23/64" (9mm) Hole Size 14mm Stem Length 13mm Top Head Diameter Natural Nylon Door Trim Panel Retainers G.M. # 94226492 Isuzu # 8-94226-492-0, Mazda # 9927-40-825, Toyota # 67771-01010, 67771-12010F	25 Pcs.		

General Motors

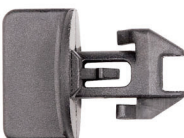
Retainers Door Trim Panel

11366PK	23/64" (9mm) Hole Size 15mm Stem Length 13mm Top Head Diameter Yellow Nylon Door Trim Panel Retainers G.M. # 95008221 Mitsubishi # MB608104 Toyota # 67771-30090	15 Pcs.		
12559PK	23/64" (9mm) Hole Size 15mm Stem Length 13mm Top Head Diameter Maroon Nylon Trim Panel Retainers G.M. # 30006620 Toyota # 67771-12050	15 Pcs.		
16091PK	23/64" (9mm) Hole Size 17mm Stem Length 15mm Top Head Diameter Natural Nylon With Sealer Door Trim Panel Retainers G.M. # 11549307	15 Pcs.		
12105PK	23/64" (9mm) Hole Size 18mm Stem Length 13mm Top Head Diameter Yellow Nylon With Sealer Door Trim Panel Retainers G.M. # 22600612, 22651066	25 Pcs.		
12895PK	23/64" (9mm) Hole Size 27.80mm Overall Length 19.50mm Head Diameter Green Nylon With Sealer Door Trim Panel Retainers G.M. # 25704141, 25762391	10 Pcs.		
10701PK	3/8" (9.50mm) Hole Size 17.00mm Stem Length 19.50mm Top Head Diameter White Nylon With Sealer Door Trim Panel Retainers Ford # W711521-S300 G.M. # 11519031	15 Pcs.		
11960PK	6.50 x 12.00mm Hole Size Black Nylon Instrument Panel Insulation Front Sight Shield Twist Lock Retainers Ford # N811772S G.M. # 2553596	25 Pcs.		
18217PK	7/16" (11mm) Hole Size 7/16" Stem Length 15/32 x 25/32" Top Head Size White Nylon With Sealer Door Trim Panel Retainers G.M. # 91176726	15 Pcs.		



18



General Motors



Retainers Door Trim Panel



12842PK	7/16" (11mm) Hole Size 17mm Stem Length 20mm Top Head Diameter White Nylon Door Trim Panel Retainers G.M. # 15076791	15 Pcs.		
----------------	---	----------------	--	---



Retainers Door Panel Pin & Grommet



10474PK	13mm Top Head Diameter 26.50mm Pin Length White Nylon Door Panel Pins Use With # 10476 G.M. # 10363811, 22722859	25 Pcs.		
----------------	---	----------------	--	---



10473PK	19.50mm Top Head Diameter 28.30mm Pin Length White Nylon Door Panel Pins Use With # 10476 G.M. # 11561499	25 Pcs.		
----------------	--	----------------	--	---

10472PK	19.50mm Top Head Diameter 28.30mm Pin Length Black Nylon Door Panel Pins Use With # 10476 G.M. # 11562241	25 Pcs.		
----------------	--	----------------	--	---

10471PK	19.50mm Top Head Diameter 30.40mm Pin Length Green Nylon Door Panel Pins Use With # 10478 G.M. # 11562242	25 Pcs.		
----------------	--	----------------	---	--

10470PK	19.50mm Top Head Diameter 30.40mm Pin Length Yellow Nylon Door Panel Pins Use With # 10478 & 10476 G.M. # 11561600	25 Pcs.		
----------------	---	----------------	--	---

10476PK	23/64" (9mm) Hole Size White Nylon With Sealer Door Panel Grommets Use with # 10470, 10472, 10473 & 10474 G.M. # 22722860	25 Pcs.		
----------------	---	----------------	--	---





10478PK	23/64" (9mm) Hole Size Yellow Nylon With Sealer Door Panel Grommets Use With # 10470 & 10471 G.M. # 11561500	25 Pcs.		
----------------	--	----------------	--	---

12049PK	15mm Top Head Diameter 34mm Stem Length Natural Nylon Door Trim Panel Retainers Use With # 12050 G.M. # 10350983	15 Pcs.		
----------------	---	----------------	--	---

18



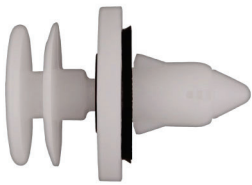

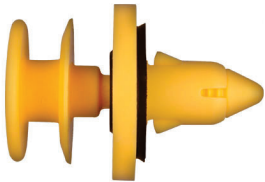

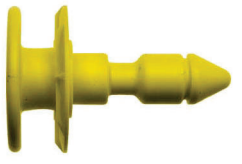

General Motors

Retainers Door Panel Pin & Grommet

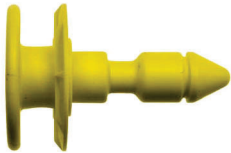
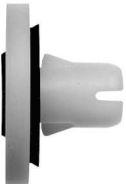
12050PK	9/32" (7mm) Hole Size 15mm Stem Length 12.00 x 14.50mm Head Size Natural Nylon Door Trim Panel Grommets Use With # 12049 G.M. # 10351052	15 Pcs.		
10135PK	23/64" (9mm) Hole Size 17.50mm Stem Length Two Part Pin & Nut White Nylon With Sealer Door Trim Panel Retainers G.M. # 11571118	15 Pcs.		
10136PK	23/64" (9mm) Hole Size 17.50mm Stem Length Two Part Pin & Nut Yellow Nylon With Sealer Door Trim Panel Retainers G.M. # 11571119	15 Pcs.		

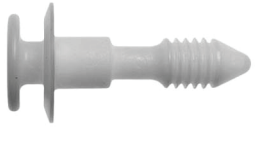
18

Set Door Panel Pin & Grommet

10529	23/64" (9mm) Hole Size Yellow Pin Yellow Grommet With Sealer Two Part Nylon Door Panel Retainers G.M. # 11562044	15 Pcs.		
10530	23/64" (9mm) Hole Size Yellow Pin White Grommet With Sealer Two Part Nylon Door Panel Retainers	15 Pcs.		
10531	23/64" (9mm) Hole Size White Pin White Grommet With Sealer Two Part Nylon Door Panel Retainers G.M. # 11562043	15 Pcs.		
10532	23/64" (9mm) Hole Size White Pin White Grommet With Sealer Two Part Nylon Door Panel Retainers G.M. # 22699649, 22704458, 22713392, 11562287	25 Pcs.		
10533	23/64" (9mm) Hole Size Black Pin White Grommet With Sealer Two Part Nylon Door Panel Retainers G.M. # 11562256	15 Pcs.		

General Motors

Set Door Panel Pin & Grommet

10534 23/64" (9mm) Hole Size
Green Pin
Yellow Grommet With Sealer
Two Part Nylon
Door Panel Retainers
G.M. # 11562257

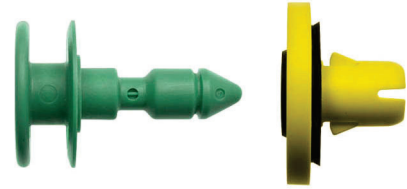

Retainers Door Panel Wire

9900PK 5/16" (8mm) Hole Size
Bright Zinc Finish
Trim Panel Fasteners
G.M. # 4114785



11876PK 12mm Width
15mm Height
Organic Zinc Finish
Windshield & Side Door Garnish Moulding
Liftgate Trim Panel Retainers
Chrysler # 6502988
G.M. # 16662182, 25580123

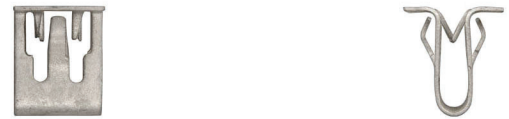

10700PK 15/32" Width
11/16" Height
Bright Zinc Finish
Interior Trim, Garnish,
Bezel & Scuff Plate Fasteners
G.M. # 11588650



10090PK 6-1.00mm Screw Size
Zinc Organic
Door Trim Panel Retainer Nuts
G.M. # 11517769



13414PK 13/16" Width
15/16" Length
Black Finish
Front Door Interior Trim &
Instrument Panel Fasteners
G.M. # 15683327



Ferrules Door Lock

9221PK 13/16" Outside Diameter
Polished Stainless Steel
With Felt Insert
Door Lock Rod Ferrule
G.M. # 330485, 9665901



Bushings Door Hinge Pin













9233PK 21/64" Inside Diameter
9/16" Outside Diameter
1/64" Thick Stainless Steel
Door Hinge Pin Retainers
Use With # 9164
G.M. # 15562610



18

General Motors

Bushings Door Hinge Pin

1267PK	.345" Inside Diameter .419" Outside Diameter .295" Height Door Hinge Pin Bushings Ford # D1AZ-6522841A G.M. # 9721917	25 Pcs.		
1268PK	.345" Inside Diameter .489" Outside Diameter .362" Height Door Hinge Pin Bushings G.M. # 20429500	25 Pcs.		
2114PK	.345" Inside Diameter .495" Outside Diameter .365" Height Door Hinge Pin Bushings G.M. # 12338074, 15964971, 15691493, 16632193	25 Pcs.		
1252PK	.346" Inside Diameter .490" Outside Diameter .375" Height Door Hinge Pin Bushings G.M. # 9716926, 20345137	25 Pcs.		
1251PK	.384" Inside Diameter .501" Outside Diameter .460" Height Door Hinge Pin Bushings G.M. # 9822198	25 Pcs.		
2115PK	.385" Inside Diameter .530" Outside Diameter .365" Height Door Hinge Pin Bushings G.M. # 15562609, 6632192, 5964972	25 Pcs.		

18

Pins Door Hinge



1289PK	4" Overall Length 11/32" Pin Diameter 7/16" Head Outside Diameter Black Zinc Finish Door Hinge Pins G.M. # 20043351, 20043361	10 Pcs.
---------------	--	----------------

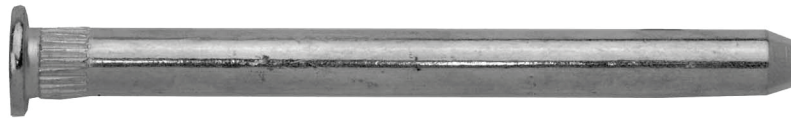

1288PK	4 1/16" Overall Length 11/32" Pin Diameter 9/16" Head Outside Diameter Bright Zinc Finish Door Hinge Pins G.M. # 6271989, 20046147	10 Pcs.
---------------	---	----------------

General Motors

Pins Door Hinge



(Yellow Zinc Finish)

9825PK

4 1/8" Length
1 1/32" Pin Diameter
1/2" Head Outsider Diameter
Yellow Zinc Steel
Door Hinge Pins
G.M. # 15653790

2 Pcs.

18



(Stainless Steel)

9164PK

5 1/4" Length
1 1/32" Pin Diameter
9/32" Head Outside Diameter
Stainless Steel
Door Hinge Pins
G.M. # 15591860, 15691595, 15691595X,
15967691, 15685040, 88891731

5 Pcs.



2168PK

5 1/2" Length
9/16" Pin Diameter
5/8" Roller Groove Diameter
19/32" Knurl Diameter
Door Roller Pin Assembly
G.M. # 12540326

Sold Each

Kits Door Hinge Pin & Bushing



(Stainless Steel Pin)

9818

G.M. Trucks C-K 1988-On
Kit Will Repair One Hinge
Stainless Steel
Door Hinge Pin & Bushing Kit

1 Kit

General Motors

Kits Door Hinge Pin & Bushing

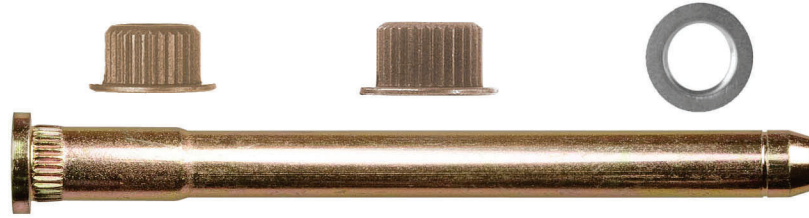

9832 G.M. S10 Trucks
1994-On
Kit Will Fix One Hinge
Door Hinge Pin & Bushing Kit

1 Kit



9833 G.M. S10 Trucks
1994-On
Kit Will Fix One Door
Door Hinge Pin & Bushing Kit

1 Kit

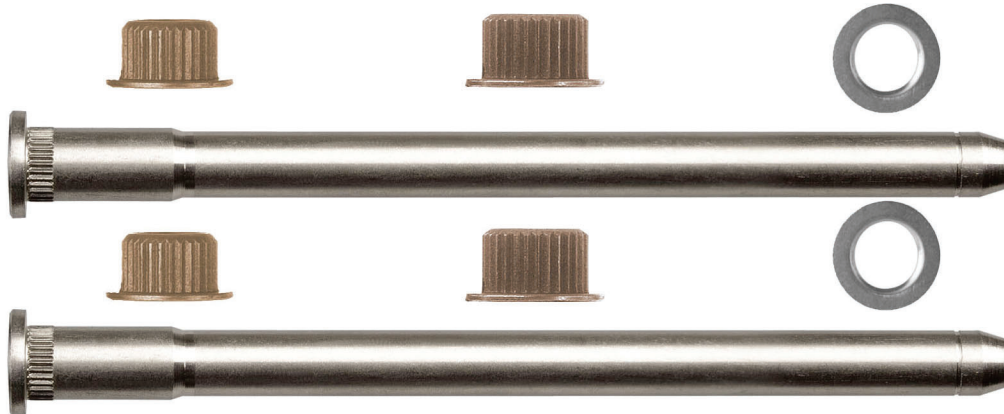

9905 G.M. Trucks C-K 1988-On
Kit Will Repair One Door
Stainless Steel
Door Hinge Pin & Bushing Kit

1 Kit

18

General Motors

Kits Door Hinge Pin & Bushing



10060

GMC Sierra & Chevrolet Silverado
& Other S.U.V 'S Hinges
Kit Will Repair One Hinge
Yellow Zinc Finish
Door Hinge Pin & Bushing Kit

1 Kit

18

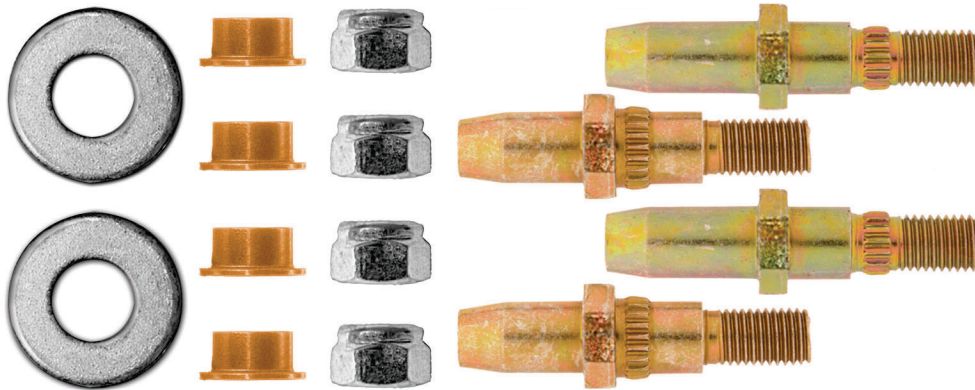

10065

GMC Sierra & Chevrolet Silverado
& Other S.U.V 'S Hinges
To Repair One Door
Yellow Zinc Finish
Door Hinge Pin & Bushing Kit

1 Kit

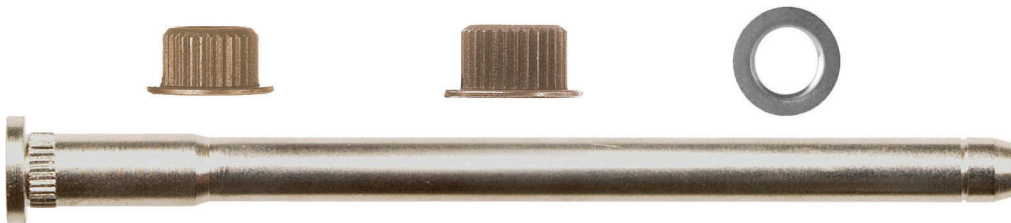

10527

G.M. Trucks C-K 1988-On
(Steel Pin) Kit Will Repair One Door
Door Hinge Pin & Bushing Kit
G.M. 15994345

1 Kit

General Motors

Kits Door Hinge Pin & Bushing

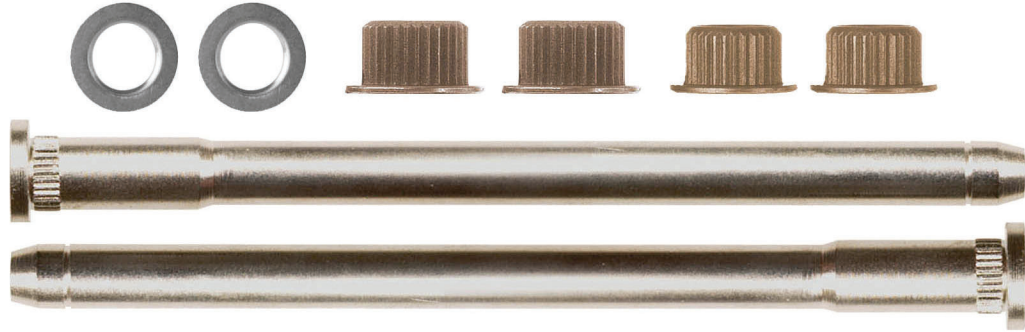

10528

G.M. Trucks C-K 1988-On
(Steel Pin) Kit Will Repair One Door
Door Hinge Pin & Bushing Kit

1 Kit

18

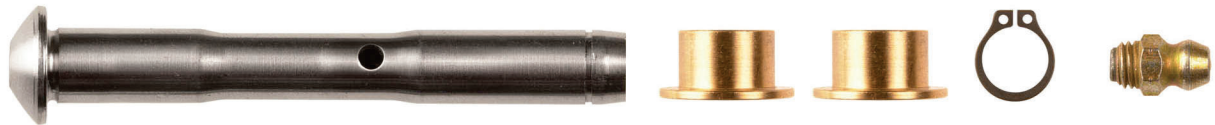

10558

Chevrolet Savana & GMC Express
Van Side Doors
Repairs One Hinge
Greaseable Stainless Steel
Door Hinge Pin & Bushing Kit
G.M. # 31028283, 88944360, 89025546

1 Kit



10559

Chevrolet Savana & G.M.C. Express
Side Cargo Door
Replacement Hinge
Van Side Doors
Use With # 10699

1 Pc.

General Motors

Kits Door Hinge Pin & Bushing



10699

Chevrolet Savana & GMC Express
Van Side Doors
Repairs One Door
Greaseable Stainless Steel
Door Hinge Pin & Bushing Kit
G.M. # 89025546

1 Kit

18



12115

Used On Upper Or Lower Hinge
Will Repair One Hinge Driver Side
Stainless Steel Pins, Nuts & Bracket
Door Hinge Repair Kit
Cadillac Escalade 02-06,
Chevrolet Avalanche 02-06,
Chevrolet Silverado 99-06,
Chevrolet Silverado Classic 07,
Chevrolet Suburban 00-06,
Chevrolet Tahoe 00-05,
GMC Sierra 99-06,
GMC Sierra Classic SLE 07,
GMC Yukon 02

1 Kit

General Motors

Kits Door Hinge Pin & Bushing

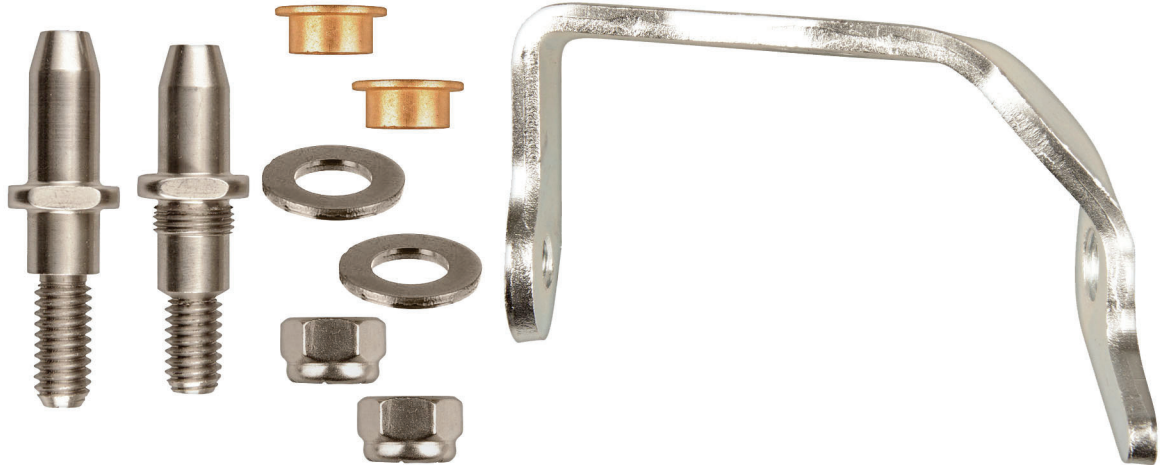

12116

Used On Upper Or Lower Hinge
Will Repair One Hinge Passenger's Side
Stainless Steel Pins, Nuts & Bracket
Door Hinge Repair Kit
Cadillac Escalade 02-06,
Chevrolet Avalanche 02-06,
Chevrolet Silverado 99-06,
Chevrolet Silverado Classic 07,
Chevrolet Suburban 00-06,
Chevrolet Tahoe 00-05,
GMC Sierra 99-06,
GMC Sierra Classic SLE 07,
GMC Yukon 02

1 Kit

18

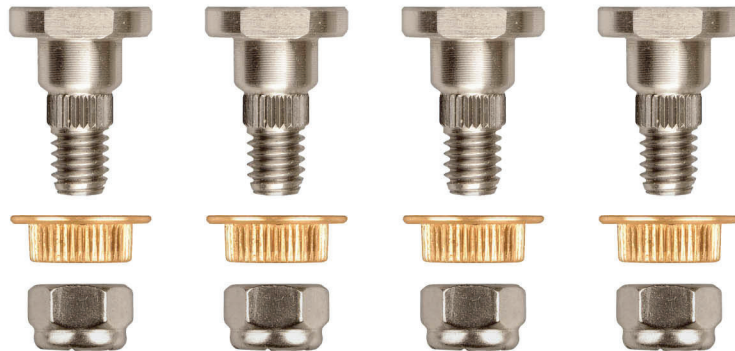

12117

Will Repair
Front Door Upper
& Lower Hinge
Stainless Steel Pins & Nuts
Door Hinge Pin &
Bushing Bracket Repair Kit
Chevrolet Cavalier & Pontiac Sunfire 95-05

1 Kit

General Motors

Kits Door Hinge Pin & Bushing



12118

Will Repair Upper & Lower Hinge
 Stainless Steel Pins & Nuts
 Door Hinge Pin &
 Bushing Bracket Repair Kit
 Cadillac Escalade &
 Cadillac Escalade ESV
 Chevrolet Avalanche 4-Door Pickup
 Chevrolet Avalanche SUV,
 Chevrolet Silverado
 Chevrolet Suburban 4-Door SUV
 Chevrolet Tahoe 4-Door SUV
 GMC Sierra, GMC Yukon &
 GMC Yukon XL 07-11

1 Kit

18



12121

C/K Series Trucks 07-10
 Will Repair One Hinge
 Used On Front Or Rear Door
 Stainless Steel Pin
 Door Hinge Pin & Roller Bracket Repair Kit

1 Kit



12123

Will Repair Extended Cab Rear Doors
 Stainless Steel Pins
 Door Pin & Bushing Hinge Repair Kit
 Chevrolet Silverado (1500, 2500, 3500)
 99-05
 Chevrolet Silverado (1500HD, 2500HD,
 3500HD) 01-05
 Chevrolet Silverado (1500, 2500HD)
 Chevrolet Silverado 1500
 GMC Sierra (1500, 2500, 3500) 99-05
 GMC Sierra (1500HD, 2500HD, 3500HD)
 01-05
 Classic Hybrid LT 06-07
 Classic Hybrid 05-078902
 G.M. # 89025543

1 Kit

General Motors

Retainers Door Window Guide



9635PK 1 5/16" Height
6" Overall Length
Black Plastic
Front Door Glass
Window Guides Retainers
G.M. # 20180140, 22543362

25 Pcs.

15010PK 1 13/32" O.A. Length
White Nylon
Front Door Window Guide
G.M.

5 Pcs.



1562PK Front & Rear Door Glass
Black Nylon
Window Guide Retainers
G.M. # 20328600, 10051034, 20123070,
12338011, 10114597

25 Pcs.

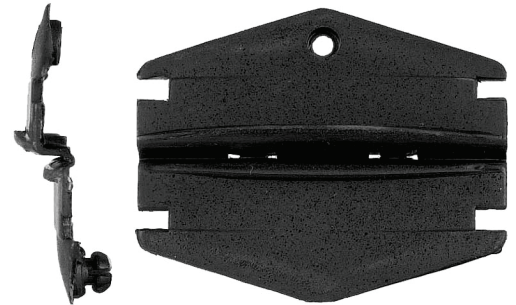

1563PK Upper Part of Glass
Black Nylon
Front Door Glass
Window Guide Retainers
G.M. # 20160591

15 Pcs.



1566PK Rear of Glass
Black Nylon
Front Door Glass
Window Guide Retainers
G.M. # 22539533, 20478733

15 Pcs.



18

General Motors

Retainers Door Window Guide

1568PK Front & Rear Door Glass
Black Nylon
Window Guide Retainers
G.M. # 20162174, 22543363

25 Pcs.



9631PK Front Door Glass
With Adhesive Gasket
Black Plastic
Window Guide Retainers
G.M. # 10051034, 10114597, 12338011

10 Pcs.



9222PK Black Nylon
Front Door Glass
Window Guide Retainers
G.M. # 20747509, 20478732

15 Pcs.



9421PK 2 3/4 x 1 3/4" Overall Size
Front of Glass 4mm Thick
Black Nylon
Front Door Glass Window Guide Retainers
G.M. # 20712176, 20712172, 20484630,
20340710, 20633504, 12353912,
20487630

15 Pcs.



1681PK 2 3/4 x 1 3/4" Overall Size
Black Nylon
Front Door Glass
Window Guide Retainers
G.M. # 12337898, 20747508, 20487631

15 Pcs.



18

General Motors

Retainers Door Window Guide

10479PK Assembled Overall
Size 1 x 2 3/8"
Gray Nylon
Front Door Window Guides
G.M. # 15786626, 10274778

10 Pcs.

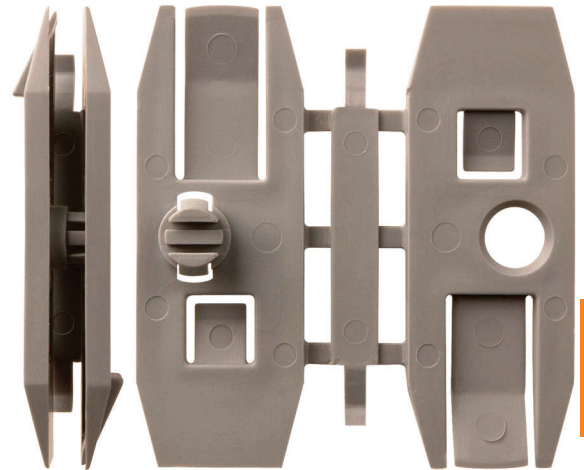

18

Adjusters Headlight

1003PK 12-28 x 1 1/2" Screw Size
Blue Nylon Nut
Headlight Adjusting
Screw & Nut Assembly
G.M. # 556196, 557057, 559312

25 Pcs.

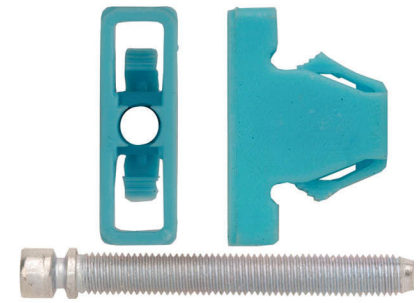

1019PK 1/4-28 x 2" Screw
Green Nylon Nut
Headlight Adjusting
Screw & Nut Assembly
G.M. # 365270, 365266

25 Pcs.



853PK 1/4-28 x 2" Screw
Pink Nylon Nut
Headlight Adjusting
Screw & Nut Assembly
AMC # SF4006204
G.M. # 1606642, 1618890, 1600375

25 Pcs.

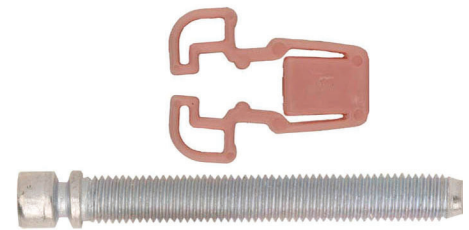

972PK 1/4-28 x 2" Screw Size
White Nylon Nut
Headlight Adjusting
Screw & Nut Assembly
G.M. # 343541, 343542, 343543, 343555,
354076, 362379, 3921446, 15705372

10 Pcs.

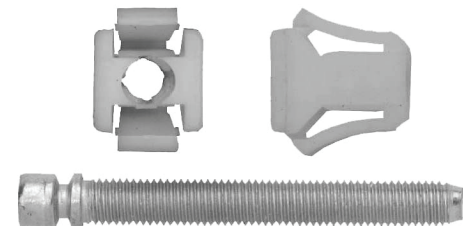

General Motors

Adjusters Headlight

656PK	1/4-28 Screw Size Natural Nylon Headlight Adjusting Nuts Use With Screw # 996 G.M. # 3921446	50 Pcs.		
9351PK	1/4-28 Screw Size White Nylon Headlight Adjusting Nuts Use With Screw # 996 G.M. # 343541, 343542, 343543, 343555, 354076, 362379	50 Pcs.		
996PK	1/4-28 x 2" Screw Bright Zinc Finish Headlight Adjusting Screws Use With Nut # 9351 & 656 G.M. # 343543, 354076, 9438150, 9432645	25 Pcs.		

Retainers Headlight

1107PK	#8 Screw Size Retainers Headlight Panel G.M. # 25501771	50 Pcs.		
---------------	---	----------------	--	--





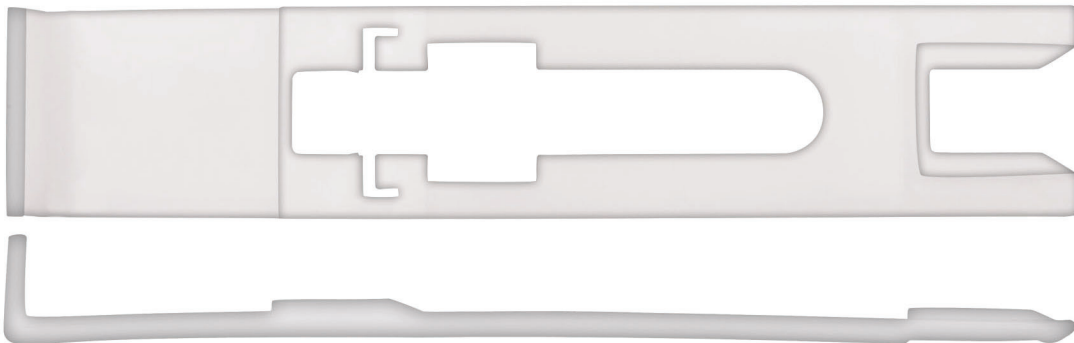







10106PK	1 1/8" Width 4 9/16" Length Natural Nylon Headlight Retainers G.M. # 10298115	10 Pcs.		
----------------	---	----------------	--	--



13036PK	1 1/8" Width 5 9/16" Length White Nylon Headlight Retainers G.M. # 15281294	10 Pcs.		
----------------	---	----------------	--	--









General Motors

Retainers Grille

11211PK	14mm Width 14mm Height White Nylon Grille Clips G.M. # 5482087	25 Pcs.		
9082PK	13mm Width 22mm Overall Length Black Plastic Grille Headlight Clips G.M. # 94218027, H200-50-715 Isuzu # 8942180270, 58974-00008 Mazda # B092-50-715, BF67-S0715 Mitsubishi # MB153825 Toyota # 90467-13011, 90467-12020	25 Pcs.		
16452PK	8 x 25.40mm Hole Size 15.50mm High 16.50 x 26.50mm Head Zinc with Blue Topcoat Radiator Grill & Quarter Trim Panel Retainers G.M. # 11519069	15 Pcs.		
10633PK	5/8" Width 1" Length 5/8" Overall Height Black Finish Radiator Grille & Bumper Cover Fasteners G.M. # 15078238, 10533681, 15162843	15 Pcs.		
9809PK	Zinc Plated Radiator Grille Retainers G.M. # 15002520, 15682898, 15709521	25 Pcs.		













18

Retainers Reveal Moulding







986PK	15.25mm Width 30.50mm Length Light Green Nylon Windshield & Rear Window Reveal Moulding Clips G.M. # 1654047	100 Pcs.		
816PK	16mm Width 18.50mm Length Green Finish Rear Window Reveal Moulding Clips G.M. # 4533699, 4506041	100 Pcs.		
2065PK	16mm Width 23mm Length Silver Finish Windshield & Rear Window Reveal Moulding Clips G.M. # 9808241	50 Pcs.		
9898PK	16.25mm Width 23mm Length Silver Finish Windshield Upper & Lower Reveal Moulding Clips G.M. # 7698976	100 Pcs.		

General Motors

Retainers Reveal Moulding

9546PK	16.75mm Width 34.75mm Length Yellow Zinc Finish Windshield and Rear Window Reveal Moulding Clips G.M. # 7693140, 8736586	50 Pcs.		
825PK	17.50mm Width 23.25mm Length Black Finish Rear Window Reveal Moulding Clips G.M. # 8717859, 9854717	100 Pcs.		
985PK	17.50mm Width 31.50mm Length White Nylon Windshield to Panel Reveal Moulding Clips AMC # 4005540 G.M. # 9731301	100 Pcs.		
817PK	18.50mm Width 34.25mm Length Black Finish Quarter Panel & Rear Windshield Reveal Moulding Clips G.M. # 7730788	50 Pcs.		
9899PK	19.00mm Width 34.50mm Length Red Finish Windshield Reveal Moulding Clips G.M. # 9895598	50 Pcs.		
9548PK	19.50mm Width 23.50mm Length Silver Finish Windshield & Rear Window Reveal Moulding Clips G.M. # 20603072, 9606232, 9662950	100 Pcs.		















Retainers Moulding

10545PK	6.00 x 16.00mm Hole Size 11mm Width 14mm Length White Nylon Front & Rear Bumper Moulding Clips G.M. # 11561857	25 Pcs.		
10804PK	15/64" (6mm) Hole Size 12.50mm Width 28mm Length Yellow Nylon With Sealer Side Window Reveal Moulding Clips GM # 11570512	10 Pcs.		
10679PK	6.50 x 12.50mm Hole Size Black Nylon Fascia Trim Cover Twist Lock Retainers G.M. # 11610049	25 Pcs.		

18

General Motors

Retainers Moulding

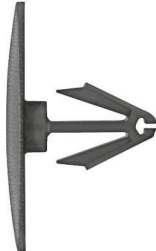
10802PK	9/32" (7mm) Hole Size 13mm Stem Length 7.50 x 11.00mm Top Head Size Green Nylon With Sealer Fender Moulding Clips G.M. # 11569920	10 Pcs.		
10823PK	9/32" (7mm) Hole Size 13mm Stem Length 13.00 x 30.00mm Top Head Size White Nylon With Sealer Roof Rail Moulding Clips G.M. # 11569918	15 Pcs.		
15311PK	5/16" (8mm) Hole Size 8mm Stem Length 3.50 x 8.00mm Top Head Size White Nylon Door & Rocker Panel Moulding Clips G.M. # 10287547	25 Pcs.		
12026PK	5/16" (8mm) Hole Size 10mm Stem Length 11.00 x 15.00mm Top Head Size White Nylon With Sealer Fender & Bumper Moulding Clips G.M. # 94530742	15 Pcs.		
12921PK	5/16" (8mm) Hole Size 11mm Stem Length 13mm Top Head Diameter Blue Nylon Garnish Moulding Retainers G.M. # 88970345 Toyota # 90467-10167	25 Pcs.		
12808PK	5/16" (8mm) Hole Size 13mm Stem Length 8.00 x 18.00mm Top Head Diameter White Nylon With Sealer Moulding Clips G.M. # 11611375	15 Pcs.		
13316PK	5/16" (8mm) Hole Size 9/16" Stem Length 11/16 x 1 5/16" Head Size Black Nylon Rocker Moulding Clips G.M. # 10431524	15 Pcs.		
9969PK	5/16" (8mm) Hole Size 11/16" Stem Length 15/32 x 1 5/16" Head Size Black Nylon Rocker Panel Moulding Clips G.M. # 10437565, 10352803	10 Pcs.		

18











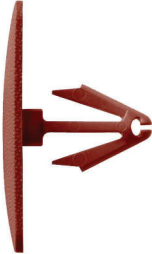

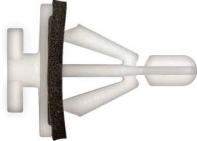

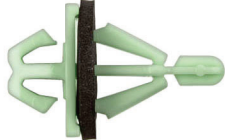
General Motors

Retainers Moulding

18	12182PK	5/16" (8mm) Hole Size 11/16" Stem Length 15/32 x 1 9/32" Head Size Maroon Nylon Rocker Moulding Clips G.M. 10352804	10 Pcs.		
	9967PK	5/16" (8mm) Hole Size 11/16" Stem Length 11/16 x 1 5/16" Head Size Black Nylon Rocker Panel Moulding Clips G.M. # 10352799	15 Pcs.		
	13420PK	5/16" (8mm) Hole Size 11/16" Stem Length 11/16 x 1 5/16" Head Size White Nylon Rocker Panel Moulding Clips G.M. # 10352809, 10426887, 10431503	15 Pcs.		
	10488PK	5/16" (8mm) Hole Size 11/16" Stem Length 11/16 x 1 5/16" Head Size Tan Nylon Rocker Panel Moulding Clips G.M. # 10431523	15 Pcs.		
	10489PK	5/16" (8mm) Hole Size 11/16" Stem Length 11/16 x 1 5/16" Head Size Gray Nylon Rocker Panel Moulding Clips G.M. # 10352797	15 Pcs.		
	10487PK	5/16" (8mm) Hole Size 11/16" Stem Length 11/16 x 1 5/16" Head Size Red Nylon Rocker Panel Moulding Clips G.M. # 10431526, 10353825	15 Pcs.		

General Motors

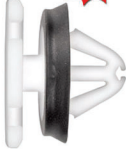
Retainers Moulding

10484PK	5/16" (8mm) Hole Size 11/16" Stem Length 11/16 x 1 5/16" Head Size Dark Red Nylon Rocker Panel Moulding Clips G.M. # 10352800	15 Pcs.		
10803PK	5/16" (8mm) Hole Size 20mm Stem Length 6.00 x 11.00mm Top Head Size White Nylon With Sealer Side Window Moulding Clips G.M. # 11610522, 10383817	10 Pcs.		
10805PK	5/16" (8mm) Hole Size 20mm Stem Length 10.00 x 17.00mm Top Head Size Green Nylon With Sealer Window Reveal Moulding Clips GM # 11569697	5 Pcs.		
10750PK	23/64" (9mm) Hole Size 10mm Stem Length 10.00 x 13.00mm Top Head Diameter Yellow Nylon Fender Flare Retainers G.M. # 88969790 Toyota # 75867-21010	25 Pcs.		
16093PK	23/64" (9mm) Hole Size 10mm Stem Length 12.00 x 20.00mm Green Nylon With Sealer Moulding Retainers G.M. # 11547210	10 Pcs.		 NEW!
12029PK	23/64" (9mm) Hole Size 10mm Stem Length 12.00 x 29.00mm Head Size Green Nylon Rocker Moulding Clips G.M. # 25922739	25 Pcs.		
12600PK	23/64" (9mm) Hole Size 11mm Stem Length 12.00 x 20.00mm Top Head Size White Nylon With Sealer Body Side & Trim Moulding Retainer GM # 11547581	25 Pcs.		 NEW!
12040PK	23/64" (9mm) Hole Size 11mm Stem Length 12.00 x 20.00mm Head Size Gray Nylon With Sealer Rocker Moulding Retainers Chrysler # 68172491AA G.M. # 11571175	15 Pcs.		

18

General Motors

Retainers Moulding

10480PK	23/64" (9mm) Hole Size 11mm Stem Length 12.00 x 20.00mm Top Head Size White Nylon Body Side Moulding Clips G.M. # 15127746	15 Pcs.		
12412PK	23/64" (9mm) Hole Size 11mm Stem Length 12.00 x 20.00mm Top Head Size White Nylon With Sealer Rocker Panel Moulding Clips G.M. # 11562250	15 Pcs.		
9667PK	23/64" (9mm) Hole Size 11mm Stem Length 12.50 x 20.00mm Top Head Size Yellow Nylon With Sealer Lower Door Moulding Retainers G.M. # 11570847	10 Pcs.		
18263PK	23/64" (9mm) Hole Size 11mm Stem Length 12.50 x 23.00mm Top Head Size White Nylon Tailgate Cover Retainer G.M. # 11611626	25 Pcs.		
16397PK	23/64" (9mm) Hole Size 12mm Stem Length 33.00 x 45.50mm Top Head Size White Nylon With Sealer Rocker Moulding Retainers G.M. # 11601845	10 Pcs.		
12908PK	23/64" (9mm) Hole Size 14mm Stem Length 9.00 x 20.00mm Top Head Size Yellow Nylon With Sealer Rocker Moulding Clips G.M. # 11546635, 11612122	10 Pcs.		
10357PK	23/64" (9mm) Hole Size 14mm Stem Length 12.00 x 20.00mm Top Head Size White Nylon Rocker Panel Moulding Clips G.M. # 10323057	15 Pcs.		
13227PK	25/64" (9mm) Hole Size 14mm Stem Length 13mm Top Head Diameter Black Nylon With Sealer Tailgate Moulding Retainers G.M. # 22691056	15 Pcs.		

18











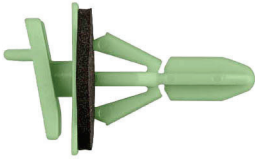

General Motors

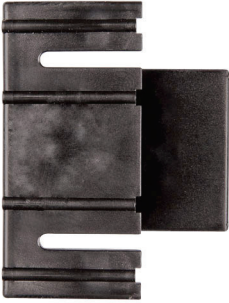
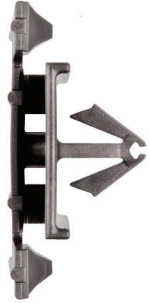
Retainers Moulding

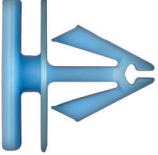
10485PK	23/64" (9mm) Hole Size 14mm Stem Length 14.00 x 20.00mm Top Head Size Yellow Nylon With Sealer Rocker Panel Moulding Clips G.M. # 5480852	10 Pcs.		
10826PK	23/64" (9mm) Hole Size 15mm Stem Length 12.00 x 20.00mm Top Head Size Black Nylon Rocker Moulding Clips Saturn	15 Pcs.		
10481PK	23/64" (9mm) Hole Size 15mm Stem Length 12.00 x 20.00mm Top Head Size Gray Nylon With Sealer Windshield Pillar Moulding Clips G.M. # 15288146, 15893516	15 Pcs.		
12272PK	23/64" (9mm) Hole Size 16mm Stem Length 12.00 x 20.00mm Top Head Size Gray Nylon With Sealer Moulding Retainers G.M. 11609923, 11609740	15 Pcs.		
15870PK	23/64" (9mm) Hole Size 16mm Stem Length 12.00 x 20.00mm Top Head Size Blue Nylon With Sealer Rocker Moulding Retainers G.M. # 11547211	10 Pcs.		 NEW!
13515PK	23/64" (9mm) Hole Size 16mm Stem Length 16.00 x 26.00mm Top Head Size White Nylon Moulding Retainers G.M. # 11588818	10 Pcs.		
18236PK	23/64" (9mm) Hole Size 20mm Stem Length 9.50 x 20.00mm Top Head Size Yellow Nylon With Sealer Rocker Moulding Clips G.M. # 15864780, 11569921	10 Pcs.		 NEW!
12030PK	23/64" (9mm) Hole Size 24mm Stem Length 12.00 x 16.00mm Head Size Yellow Nylon Door Moulding Clips G.M. # 25774893	15 Pcs.		

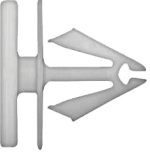
General Motors



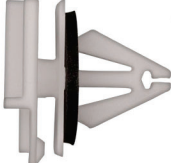





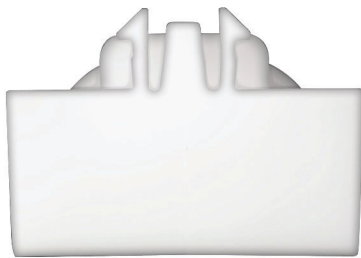

Retainers Moulding

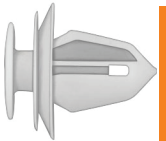
12032PK	23/64" (9mm) Hole Size 24mm Stem Length 12.00 x 16.00mm Head Size Green Nylon With Sealer Rocker Moulding Clips G.M. # 25775903	10 Pcs.		
15008PK	3/8" (9.50mm) Hole Size 3/8" Stem Length 9/16 x 3/4" Head Size Yellow Nylon Door Trim Moulding Retainers G.M. # 25718851	25 Pcs.		
15018PK	3/8" (9.50mm) Hole Size 7/16" Stem Length 9/16 x 23/32" Head Size White Nylon Rocker Panel Moulding Clips G.M. # 15236894	15 Pcs.		
15298PK	3/8" (9.50mm) Hole Size 7/16" Stem Length 3/4 x 1 9/16" Top Head Size Black Nylon Rocker Panel Moulding Retainers G.M. # 15236893	15 Pcs.		
13106PK	3/8" (9.50mm) Hole Size 9/16" Stem Length 9/16 x 25/32" Head Size Blue Nylon Rocker Panel Moulding Clips G.M. # 25742293	15 Pcs.		
10680PK	3/8" (9.50mm) Hole Size 9/16" Stem Length 9/16 x 13/16" Top Head Size White Nylon Rocker & Grille Moulding Clips G.M. # 25724529	15 Pcs.		
12109PK	3/8" (9.50mm) Hole Size 9/16" Stem Length 3/4 x 1 1/32" Head Size White Nylon Rocker Panel Moulding Clips G.M. # 11589176	15 Pcs.		
13039PK	3/8" (9.50mm) Hole Size 15mm Stem Length 12.00 x 20.00mm Head Diameter White Nylon Fender Moulding Clips With Sealer G.M. 11518988	15 Pcs.		

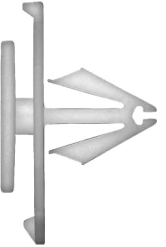
18

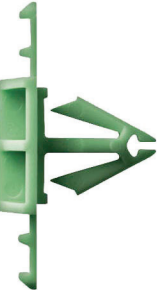
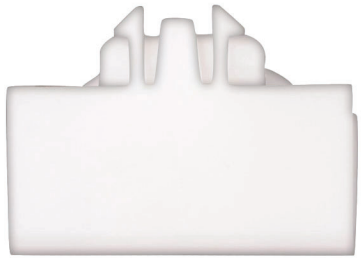
General Motors

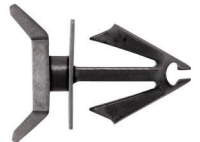

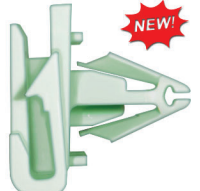









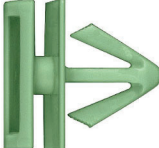

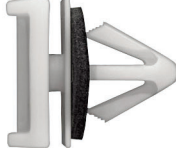
Retainers Moulding

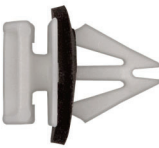
16348PK	9.00 x 20.00mm Hole Size 15mm Stem Length 33.00 x 45.00mm Top Head Size White Nylon Rocker Panel Mldg Retainers G.M. # 11549137	10 Pcs.		
17929PK	25/64" (10mm) Hole Size 14mm Stem Length 13mm Top Head Diameter White Nylon Trim Moulding Retainers G.M. # 11546850	50 Pcs.		
10827PK	25/64" (10mm) Hole Size 15mm Stem Length 12.00 x 20.00mm Top Head Size White Nylon Rocker Moulding Clips G.M. # 11562563	15 Pcs.		
10482PK	25/64" (10mm) Hole Size 15mm Stem Length 16.00 x 38.00mm Top Head Size Green Nylon Body Side Moulding Clips G.M. # 15116576, 15282120	15 Pcs.		
12909PK	25/64" (10mm) Hole Size 15mm Stem Length 22.00 x 45.00mm Top Head Size White Nylon With Sealer Moulding Clips G.M. # 11611435	10 Pcs.		
13208PK	25/64" (10mm) Hole Size 15mm Stem Length 18.00 x 26.00mm Top Head Size Black Nylon Moulding Retainers G.M. # 11561329	10 Pcs.		
16087PK	25/64" (10mm) Hole Size 17mm Stem Length 22.00 x 46.00mm Head Size Green Nylon Rocker Moulding Retainers G.M. # 25744385	15 Pcs.		

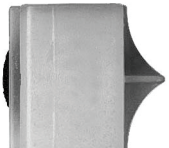
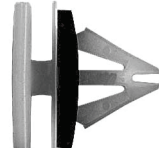
18

General Motors

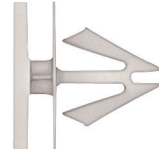





Retainers Moulding

10059PK	7/16" (11mm) Hole Size 17/32" Stem Length 7/8" Width 2" Length Gray Nylon Rocker Panel Moulding Clips G.M. # 25722671	10 Pcs.		
9914PK	7/16" (11mm) Hole Size 9/16" Stem Length 15/32 x 13/16" Top Head Size Green Nylon Rocker Panel Moulding Clips G.M. # 10423553	15 Pcs.		
9991PK	7/16" (11mm) Hole Size 9/16" Stem Length 15/32 x 25/32" Top Head Size Natural Nylon With Sealer Rear Wheel Opening Moulding Clips G.M. # 10297368	10 Pcs.		
12512PK	7/16" (11mm) Hole Size 9/16" Stem Length 1/2 x 9/16" Top Head Size White Nylon With Sealer Rocker Panel Moulding Clips G.M. # 10442914	15 Pcs.		
10127PK	7/16" (11mm) Hole Size 9/16" Stem Length 9/16 x 3/4" Top Head Size Gray Nylon Rocker Panel Moulding Clips G.M. # 25693852	25 Pcs.		
10129PK	7/16" (11mm) Hole Size 9/16" Stem Length 9/16 x 13/16" Top Head Size Natural Nylon With Sealer Rocker Panel Moulding Clips G.M. # 11518357	15 Pcs.		
9992PK	7/16" (11mm) Hole Size 9/16" Stem Length 9/16 x 13/16" Top Head Size Black Nylon Front Fender With Opening Moulding Clips G.M. # 10242298	25 Pcs.		
9915PK	7/16" (11mm) Hole Size 9/16" Stem Length 9/16 x 13/16" Top Head Size White Nylon Rocker Panel Moulding Clips G.M. # 10443956	15 Pcs.		
10429PK	7/16" (11mm) Hole Size 9/16" Stem Length 9/16 x 1 1/8" Top Head Size Gray Nylon Rocker Panel Moulding Clips G.M. # 15221959	15 Pcs.		

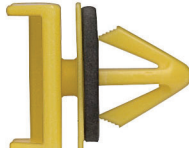
18

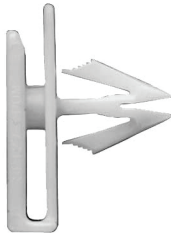
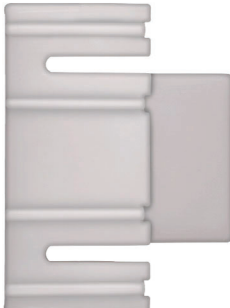
General Motors

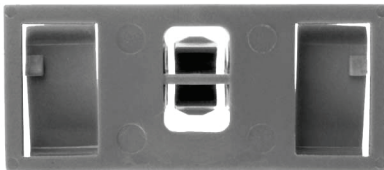
Retainers Moulding

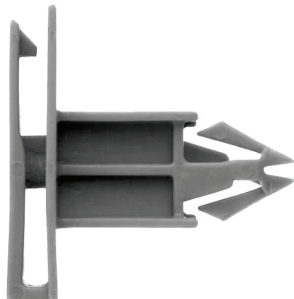
9990PK	7/16" (11mm) Hole Size 9/16" Stem Length 19/32 x 25/32" Top Head Size Yellow Nylon With Sealer Rear Wheel Opening Moulding Clips G.M. # 10297371	15 Pcs.		
10056PK	7/16" (11mm) Hole Size 19/32" Stem Length 3/4 x 1" Top Head Size White Nylon Rocker Panel Moulding Clips G.M. # 22603384	15 Pcs.		
15299PK	7/16" (11mm) Hole Size 21/32" Stem Length 3/4 x 1 9/16" Head Size White Nylon Rocker Moulding Retainers G.M. # 10384814	15 Pcs.		
10128PK	7/16" (11mm) Hole Size 21/32" Stem Length 7/8" Width 2" Length Gray Nylon Rocker Moulding Clips G.M. # 25648693	10 Pcs.		
15154PK	7/16" (11mm) Hole Size 1 3/8" Stem Length 15/32 x 27/32" Top Head Size Yellow Nylon W/Sealer Rocker Panel Moulding Clips G.M. # 11589244, 11569973	10 Pcs.		
10058PK	7/16" (11mm) Hole Size 1 1/4" Stem Length 1 1/16 x 1 1/2" Top Head Size Gray Nylon Rocker Panel Moulding Clips G.M. # 10431761, 10411395	15 Pcs.		











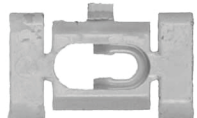

General Motors

Retainers Moulding

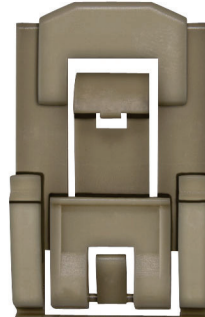
13235PK	7/16" (11mm) Hole Size 33mm Stem Length 18.00 x 38.00mm Top Head Size Black Nylon Rocker, Pillar & Floor Moulding Clips G.M. # 10363352	15 Pcs.		
10651PK	43/64" (17mm) Hole Size 12mm Stem Length 20.00 x 30.00mm Top Head Size Black Nylon With Sealer Rocker Panel Moulding Clips G.M. # 11561491, 15872008	10 Pcs.		
15155PK	7/8" (22mm) Hole Size 10mm Stem Length 32mm Head Diameter Black Nylon Rocker Moulding Retainers G.M. # 88970495, 88973654 Toyota # 76924-52021, 76924-02010, 76924-02020	25 Pcs.		
12656PK	#8 (4.20mm) Screw Size 13mm Width 22mm Length 13.50 x 20.50mm Head Size Zinc Finish Garnish Moulding Clips G.M. # 11609651	15 Pcs.		
9853PK	7/16" Width 25/32" Length Natural Nylon Quarter Panel and Reveal Moulding Clips G.M. # 7731589	100 Pcs.		
1159PK	7/16" Width 31/32" Length White Nylon Quarter Belt Reveal Moulding Clips G.M. # 20199675	50 Pcs.		
9895PK	31/64" Width 57/64" Length White Nylon Door, Quarter Panel & Rear End Moulding Clips G.M. # 8799350	50 Pcs.		
12389PK	1/2" Width 5/8" Overall Length Zinc Finish Garnish Moulding Retainers G.M. # 15748479	25 Pcs.		

General Motors

Retainers Moulding

987PK	33/64" Width 27/32" Length Gray Nylon Door & Body Side Moulding Clips G.M. # 9838109	100 Pcs.		
1172PK	9/16" Width 61/64" Length White Nylon Quarter Belt Reveal Moulding Clips G.M. # 20175051, 15633873	50 Pcs.		
12843PK	7/8" Width 2" Length Black Nylon Rocker Panel Molding Clips G.M. # 25691949, 25704001	10 Pcs.		
13100PK	26mm Width 43mm Length Light Brown Nylon Belt Molding Clips G.M. # 11547339	15 Pcs.		
12133PK	Windshield Black Nylon Upper Garnish Moulding Clips G.M. # 20058837	10 Pcs.	 <p style="text-align: center;">Not Actual Size</p>	
12805PK	11.50 x 21.00mm Head Size 11mm Stem Length 17mm Overall Height White Nylon Moulding Clips Chrysler # 68225214-AA G.M. # 11547341	50 Pcs.		
13519PK	10mm Stem Length 17.00 x 24.00mm Top Head Red Nylon With Sealer & Metal Reinforced Door Sill Plate Retainers G.M. # 11547024	10 Pcs.		

18

General Motors

Retainers Moulding

14995PK	<p>10mm Stem Length 17.00 x 24.00mm Top Head Size Blue Nylon With Sealer Interior Trim & Windshield Pillar Moulding Retainers G.M. # 11611367</p>	10 Pcs.		
17588PK	<p>10mm Stem Length 17.00 x 24.00mm Top Head Size Red Nylon With Metal Reinforced Interior Trim & Windshield Garnish Moulding Retainers G.M. # 11547026</p>	10 Pcs.		
13104PK	<p>10mm Stem Length 17.00 x 24.00mm Top Head Size Blue Nylon With Metal Reinforced Interior Trim & Windshield Pillar Moulding Retainers G.M. # 11611623</p>	10 Pcs.		
18095PK	<p>11mm Stem Length 17.00 x 20.00mm Top Head Size Blue Nylon With Metal Reinforced Windshield Pillar, Interior & Trunk Trim Moulding Retainers G.M. # 24405740</p>	15 Pcs.		
18165PK	<p>12mm Stem Length 17.00 x 20.00mm Top Head Size Black Nylon With Metal Reinforced Windshield Pillar, Interior Moulding Retainers G.M. # 24405739</p>	15 Pcs.		
18119PK	<p>19mm Stem Length 19mm Overall Height 17.50 x 25.00mm Head Size Black Finish Grille Assembly Retainer G.M. # 11546500</p>	10 Pcs.		
16310PK	<p>8mm Width 15mm Height White Nylon Quarter Panel & Exterior Trim Moulding Clips Ford # W714972-S300 GM # 94748652</p>	25 Pcs.		

General Motors

Retainers Universal Moulding

308PK

3/8" Hole Size
Front & Rear Door
Universal Moulding Clips
G.M. # 4759145, 4761842, 4779348

50 Pcs.

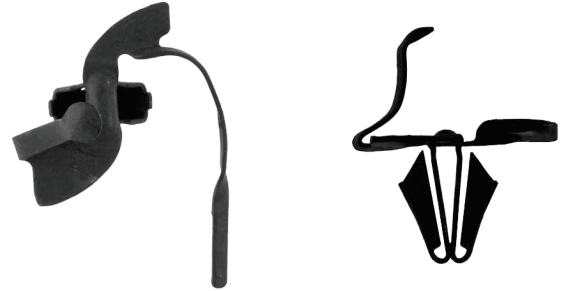

2194PK

10-24 x 3/4" Screw Size
3/4 x 2 1/2" Plate Size
Breaks Off In 1/16"
Bright Zinc Finish
Moulding Tee Bolts

25 Pcs.



18

347PK

10-24 x 3/4" Screw Size
11/32 x 23/32" Plate Size
Universal
Moulding Clips
Chrysler # 1624705, 6010093
G.M. # 4689929, 4778814

50 Pcs.



9879PK

10-24 x 3/4" Screw Size
1/2 x 1 1/16" Plate Size
Universal Moulding Clips
Chrysler # 1560058, 6010029
Ford # 358560
G.M. # 568792, 574355, 1165051

25 Pcs.



345PK

10-24 x 3/4" Screw Size
1/2 x 1 25/64" Plate Size
Universal Moulding Clips
Chrysler # 6000705, 6013029
G.M. # 3722635

50 Pcs.



General Motors

Retainers Universal Moulding

344PK

10-24 x 3/4" Screw Size
9/16 x 1 25/32" Plate Size
Universal
Moulding Clips
Chrysler # 1758099, 6000720, 6010046
G.M. # 3744999

50 Pcs.

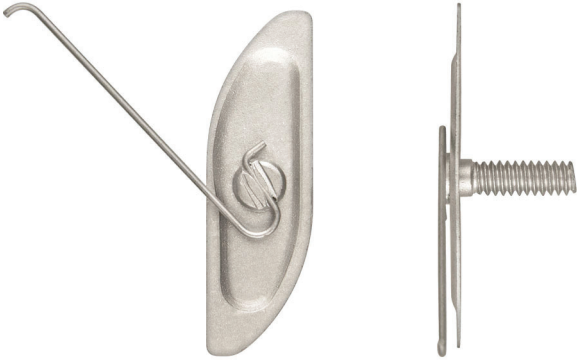

9711PK

10-24 x 3/4" Screw Size
11/16 x 2 17/32" Plate Size
Commercial Zinc Finish
Universal Moulding Clips
G.M. # 4676189

15 Pcs.

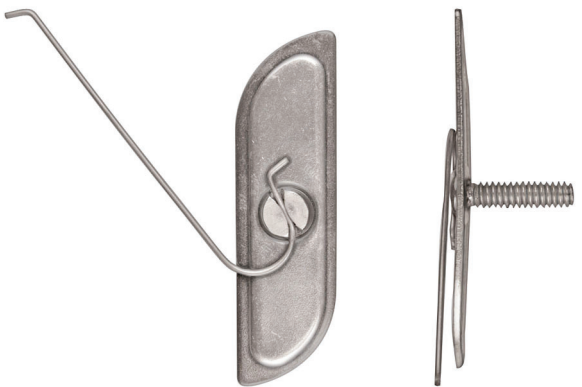

315PK

13/16 x 2 1/8" Plate Size
Universal
Moulding Clips

25 Pcs.



18