

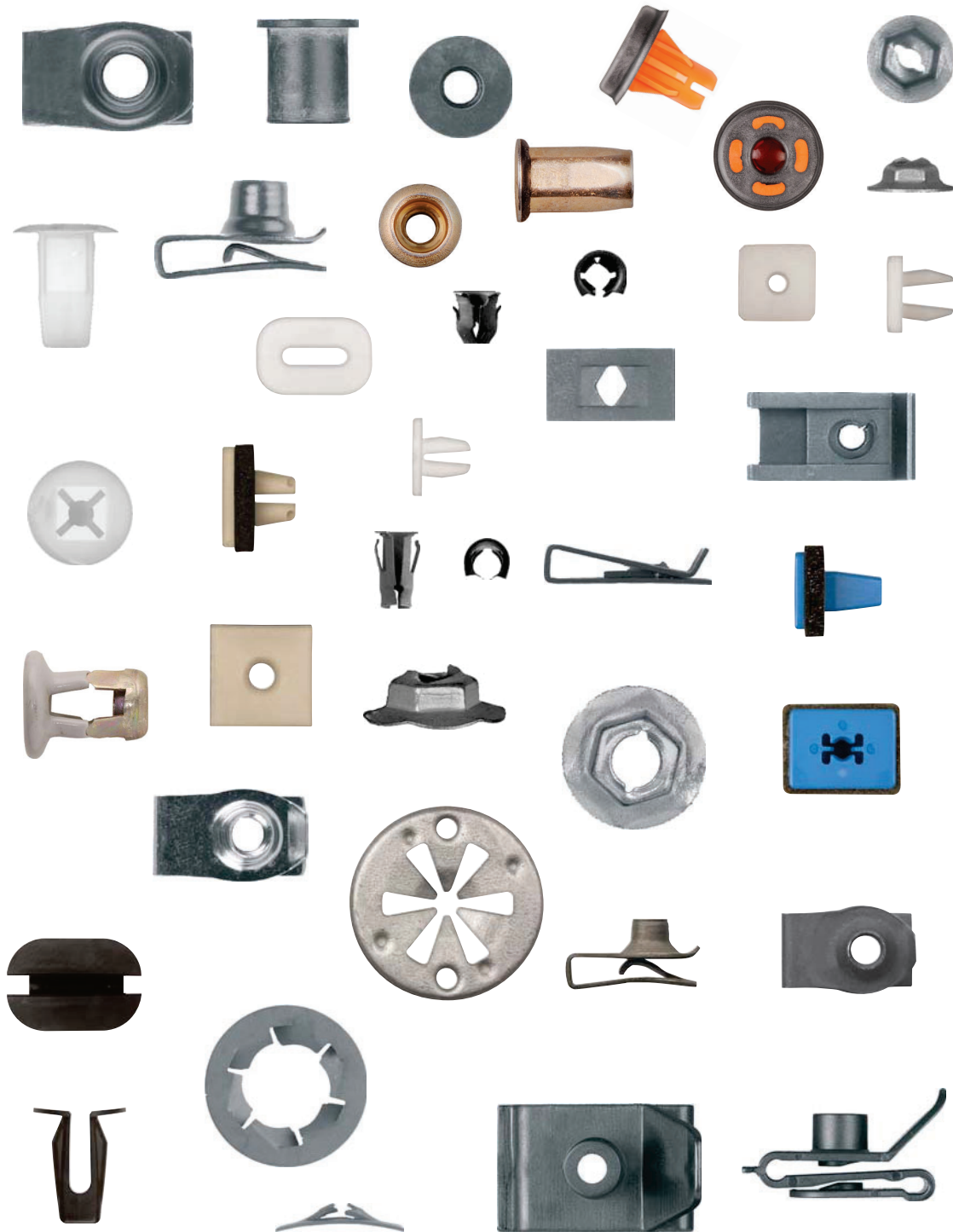











# Specialty Nuts







5

# Specialty Nuts





## Nuts Barrel

<b>708PK</b>	1/8" Stud Size 5/32" Hole Size Black Finish Barrel Nuts	100 Pcs.		
<b>709PK</b>	1/8" Stud Size 3/16" Hole Size Black Finish Barrel Nuts Ford # 375890-S100	100 Pcs.		
<b>710PK</b>	1/8" Stud Size 1/4" Hole Size Black Finish Barrel Nuts Ford # 375480-S100, 3783794	100 Pcs.		
<b>711PK</b>	3/16" Stud Size 7/32" Hole Size Black Finish Barrel Nuts Chrysler # 6000558	100 Pcs.		
<b>9878PK</b>	3/16" Stud Size 17/64" Hole Size Black Nylon Barrel Nuts Ford # D7VY-6050074-A Renault # 8934-201-767	100 Pcs.		
<b>9941PK</b>	1/4" Stud Size 9/32" Hole Size Black Finish Barrel Nuts Ford # 354341-S	100 Pcs.		

## Nuts Flat Type Speed



<b>690PK</b>	3/16" Stud Size 3/8 x 5/8" Plate Size Black Finish Flat Type Speed Nuts	100 Pcs.		
<b>9894PK</b>	#10-24 Stud Size 7/16 x 3/4" Plate Size Black Phosphate Finish Flat Type Speed Nuts	100 Pcs.		

## Nuts Push On Type Non-Threaded Stud

<b>1684PK</b>	1/8" Stud Size 3/8" Outside Diameter Flange Zinc Finish Push On Type Retainers	100 Pcs.	
<b>1685PK</b>	5/32" Stud Size 7/16" Outside Diameter Flange Zinc Finish Push On Type Retainers	100 Pcs.	
<b>1686PK</b>	3/16" Stud Size 7/16" Outside Diameter Flange Zinc Finish Push On Type Retainers Chrysler # 6031147	100 Pcs.	
<b>1687PK</b>	1/4" Stud Size 17/32" Outside Diameter Flange Zinc Finish Push On Type Retainers	100 Pcs.	
<b>12655PK</b>	3/8" Screw Size 3/4" Outside Diameter Flange Zinc Finish Push On Retainers	100 Pcs.	

# Specialty Nuts







## Nuts Push On Type Non-Threaded Stud Metric

<b>9850PK</b>	3.20mm Stud Size 9.50mm Outside Diameter Flange Zinc Finish Push On Type Retainers G.M. # 11502794	<b>100 Pcs.</b>	
<b>1691PK</b>	4mm Stud Size 11mm Outside Diameter Flange Black Finish Push On Type Retainers	<b>100 Pcs.</b>	

## Nuts Specialty

<b>16383PK</b>	3.50mm Stud Size 12mm Outside Diameter Stainless Steel Emblem Push Nuts Mazda # 9957-83-000	<b>50 Pcs.</b>	
----------------	---------------------------------------------------------------------------------------------------------	----------------	-------------------------------------------------------------------------------------









## Nuts Push On Type Threaded Stud

<b>9852PK</b>	#8 (5/32") Screw Size 3/8" Outside Diameter Flange Black Finish Push On Type Retainers	<b>100 Pcs.</b>	
<b>12912PK</b>	#10 (3/16") Screw Size 7/16" Outside Diameter Flange Black Finish Push On Type Retainers Chrysler # 6029348	<b>100 Pcs.</b>	
<b>1273PK</b>	1/4" Screw Size 1/2" Outside Diameter Flange Black Finish Push On Type Retainers Chrysler # 6026958	<b>100 Pcs.</b>	
<b>1274PK</b>	5/16" Screw Size 5/8" Outside Diameter Flange Zinc Finish Push On Type Retainers Chrysler # J4004354, J4005293	<b>100 Pcs.</b>	
<b>989PK</b>	3/8" Screw Size 25/32" Outside Diameter Flange Black Finish Push On Type Retainers Chrysler # J4004354	<b>100 Pcs.</b>	
<b>990PK</b>	7/16" Screw Size 27/32" Outside Diameter Flange Black Finish Push On Type Retainers Chrysler # J4004175	<b>100 Pcs.</b>	
<b>991PK</b>	1/2" Screw Size 15/16" Outside Diameter Flange Black Finish Push On Type Retainers Chrysler # 6026430	<b>100 Pcs.</b>	

5

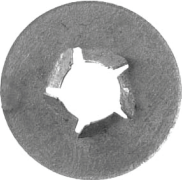
# Specialty Nuts

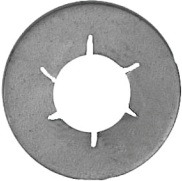
## Nuts Push On Type Threaded Stud Metric

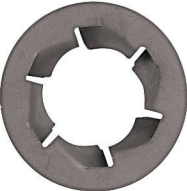
<b>12023PK</b>	5-.80mm Screw Size 11mm Outside Diameter Flange Zinc Finish Push On Type Retainers Chrysler # 6100839	<b>100 Pcs.</b>	
<b>1275PK</b>	6-1.00mm Screw Size 12.70mm Outside Diameter Flange Zinc Finish Push On Type Retainers	<b>100 Pcs.</b>	
<b>1621PK</b>	6-1.00mm Screw Size 17mm Outside Diameter Flange Zinc Plated Push On Type Retainers Chrysler # 6501178, 6501192 Ford # N801192S36 G.M. # 11503736, 11609738, 14093869	<b>100 Pcs.</b>	
<b>1043PK</b>	8-1.25mm Screw Size 16mm Outside Diameter Flange Zinc Finish Push On Type Retainers Chrysler # 6501025 G.M. # 11502504, 11502853	<b>100 Pcs.</b>	
<b>3010PK</b>	8-1.25mm Screw Size 24mm Outside Diameter Flange Zinc Finish Bumper Strip Retainers Chrysler # 6501825 G.M. # 10009923	<b>50 Pcs.</b>	
<b>9335PK</b>	10-1.50mm Screw Size 20mm Outside Diameter Flange Black Finish Push On Type Retainers G.M. # 11502759	<b>50 Pcs.</b>	
<b>1276PK</b>	10-1.50mm Screw Size 24mm Outside Diameter Flange Dacromet Finish Push On Type Retainers G.M. # 11501849	<b>50 Pcs.</b>	
<b>1044PK</b>	12-1.75mm Screw Size 21.40mm Outside Diameter Flange Black Finish Push On Type Retainers G.M. # 11502737	<b>50 Pcs.</b>	
<b>9952PK</b>	14-2.00mm Screw Size 25mm Outside Diameter Flange Black Finish Push On Type Retainers G.M. # 11504119	<b>50 Pcs.</b>	

5

# Specialty Nuts

## Nuts Push On Type Threaded Stud Metric

**17093PK** 16mm Screw Size  
35mm Outside Diameter Flange  
Zinc Finish  
Push On Type Retainers  
Ford # W721197-S437M

25 Pcs.



## Nuts Thread Cutting

**265PK** 1/8" Stud Size  
5/16" Hex Size  
17/32" Flange Diameter  
Zinc Finish  
Thread Cutting Nuts

100 Pcs.



**264PK** 5/32" Stud Size  
3/8" Hex Size  
9/16" Flange Diameter  
Zinc Finish  
Thread Cutting Nuts

100 Pcs.

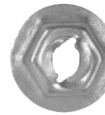

**9847PK** 3/16" Stud Size  
3/8" Hex Size  
1/2" Flange Diameter  
Zinc Finish  
Thread Cutting Nuts  
Chrysler # 6006264

200 Pcs.



**263PK** 3/16" Stud Size  
3/8" Hex Size  
5/8" Flange Diameter  
Zinc Finish  
Thread Cutting Nuts

100 Pcs.



**262PK** 1/4" Stud Size  
7/16" Hex Size  
19/32" Flange Diameter  
Zinc Finish  
Thread Cutting Nuts

100 Pcs.



**9226PK** 1/4" Stud Size  
7/16" Hex Size  
11/16" Flange Diameter  
Zinc Finish  
Thread Cutting Nuts

100 Pcs.



**856PK** 5/16" Stud Size  
1/2" Hex Size  
7/8" Flange Diameter  
Zinc Finish  
Thread Cutting Nuts

50 Pcs.



## Nuts Thread Cutting Metric

**1040PK** 4mm Stud Size  
9mm Hex Size  
15mm Flange Diameter  
Zinc Finish  
Thread Cutting Nuts

100 Pcs.





5

# Specialty Nuts

## Nuts Thread Cutting Metric

5	<b>1041PK</b>	5mm Stud Size 10mm Hex Size 15mm Flange Diameter Black Finish Thread Cutting Nuts G.M. # 11501835, 11508900, 11510062, 11501932 Ford # W707501-S300	50 Pcs.		
	<b>1042PK</b>	6.30mm Stud Size 11mm Hex Size 18mm Flange Diameter Zinc Finish Thread Cutting Nuts G.M. # 11501836, 11503432	50 Pcs.		
	<b>1622PK</b>	8mm Stud Size 13mm Hex Size 20mm Flange Diameter Zinc Finish Thread Cutting Nuts G.M. # 11502507, 11509535, 11514282	100 Pcs.		
	<b>16368PK</b>	8mm Stud Size 13mm Hex Size 20mm Flange Diameter Black Finish Thread Cutting Nuts	100 Pcs.		



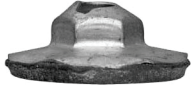



## Nuts Lock Zinc Plated

<b>11865PK</b>	1/4-20 Screw Size 7/16" Hex Size 19/32" Flange Diameter Zinc Finish Washer Lock Nuts	100 Pcs.		
<b>11140PK</b>	6-1.00mm Stud Size 11mm Hex Size 24mm Flange Diameter Metallic Gray Finish With Sealer Locking Washer Nuts G.M. # 11505865	25 Pcs.		

## Nuts Miscellaneous





<b>18451PK</b>	5mm Stud Size 10mm Hex 15mm Flange Zinc Finish Locking Teeth Emblem Nuts Ford # W706675-S439	50 Pcs.		
----------------	-------------------------------------------------------------------------------------------------------------	---------	--------------------------------------------------------------------------------------	---------------------------------------------------------------------------------------

## Nuts Hex Flange Type Standard









<b>259PK</b>	10-24 Screw Size 3/8" Hex Size 31/64" Outside Diameter Serrated Flange Bright Zinc Finish Hex Flange Nuts	100 Pcs.			
<b>11331PK</b>	10-24 Screw Size 3/8" Hex Size 31/64" Outside Diameter Serrated Flange Black Finish Hex Flange Nuts	100 Pcs.			

# Specialty Nuts



## Nuts Hex Flange Type Standard

<b>9883PK</b>	1/4-20 Screw Size 7/16" Hex Size 19/32" Outside Diameter Flange Black Nylon Hex Flange Nuts	<b>50 Pcs.</b>		
<b>18316PK</b>	3/8-16 (USS) Screw Size 9/16" Hex Size 29/32" Outside Diameter Flange Zinc Finish Serrated Flange Nuts	<b>50 Pcs.</b>		

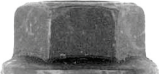

## Nuts Hex Flange Type Metric

<b>5797PK</b>	5-.80mm Screw Size 8mm Hex Size 11.80mm Outside Diameter Flange Black Finish Metric Hex Flange Nuts G.M. # 11502722, 11502702	<b>50 Pcs.</b>		
<b>5800PK</b>	6-1.00mm Screw Size 10mm Hex Size 16mm Outside Diameter Serrated Flange Black Finish Metric Hex Flange Nuts	<b>100 Pcs.</b>		
<b>11191PK</b>	8-1.25mm Screw Size 13mm Hex Size 17mm Outside Diameter Flange Black Finish Metric Hex Flange Nuts G.M. # 11501889, 11507036, 11502609, 11514518, 11514596	<b>25 Pcs.</b>		
<b>5805PK</b>	8-1.25mm Screw Size 13mm Hex Size 19mm Outside Diameter Serrated Flange Black Finish Metric Hex Flange Nuts	<b>100 Pcs.</b>		
<b>1017PK</b>	10-1.50mm Screw Size 15mm Hex Size 21mm Outside Diameter Flange Black Finish Metric Hex Flange Nuts G.M. # 11501850	<b>25 Pcs.</b>		

## Nuts Hex Loose Washer Standard

<b>17921PK</b>	1/4-20 Screw Size 7/16" Hex Size 5/8" Outside Diameter Loose Washer Yellow Zinc Finish Hex Nuts G.M. # 3866846 Ford # 385400, 45334 Chrysler # 6023204, 6025004, 6033560	<b>50 Pcs.</b>		
----------------	-----------------------------------------------------------------------------------------------------------------------------------------------------------------------------------------------	----------------	---------------------------------------------------------------------------------------	---------------------------------------------------------------------------------------

















## Nuts Hex Loose Washer Metric

<b>12053PK</b>	5-.80mm Thread Size 8mm Hex Size 10mm Outside Diameter Loose Washer Yellow Zinc Finish Metric Hex Nuts Ford # N802775-S36	<b>50 Pcs.</b>		
----------------	------------------------------------------------------------------------------------------------------------------------------------------	----------------	---------------------------------------------------------------------------------------	---------------------------------------------------------------------------------------

5

# Specialty Nuts

## Nuts Hex Loose Washer Metric

<b>1639PK</b>	5-.80mm Screw Size 10mm Hex Size 15mm Outside Diameter Loose Washer Black Finish Metric Hex Nuts AMC # 4200408 Ford # N621903-S61, N621903-S2 G.M. # 11504614	<b>50 Pcs.</b>		
<b>12892PK</b>	5 - .80mm Screw Size 10mm Hex Size 19mm Outside Diameter Loose Washer Black Finish Metric Hex Nuts G.M. # 11504614	<b>50 Pcs.</b>		
<b>5910PK</b>	6-1.00mm Screw Size 10mm Hex Size 16mm Outside Diameter Loose Barbed Washer Black Finish Metric Hex Nuts G.M. # 11505329, 11503752 V.W. # N90100001	<b>25 Pcs.</b>		
<b>13503PK</b>	6-1.00mm Thread Size 10mm Hex Size 18mm Outside Diameter Loose Washer Black Finish Metric Hex Nuts Chrysler # 6100048, 6500284	<b>50 Pcs.</b>		
<b>5915PK</b>	6-1.00mm Screw Size 10mm Hex Size 19mm Outside Diameter Loose Barbed Washer Black Phosphate Finish Metric Hex Nuts Chrysler # 6100049, 34201358	<b>25 Pcs.</b>		
<b>11896PK</b>	6-1.00mm Screw Size 11mm Hex Size 19mm Outside Diameter Loose Washer Black Finish Metric Hex Nuts G.M. # 11503754, 11503756, 11505005, 11517293, 11609411	<b>25 Pcs.</b>		
<b>12055PK</b>	6-1.00mm Screw Size 11mm Hex Size 24mm O.D. Loose Washer Yellow Zinc Finish Metric Hex Nuts Ford # N621907, N621907-S55	<b>25 Pcs.</b>		
<b>10838PK</b>	8-1.25mm Screw Size 13mm Hex Size 18mm Outside Diameter Loose Barbed Washer Black Phosphate Finish Metric Hex Nuts Chrysler # 6100050	<b>25 Pcs.</b>		

5

# Specialty Nuts

## Nuts Hex Loose Washer Metric

**5916XPK** 8-1.25mm Screw Size  
13mm Hex Size  
24mm Outside Diameter  
Loose Barbed Washer  
Black Finish  
Metric Hex Nuts  
Ford # N621940-S424  
G.M. # 11503695, 11506117, 11516780,  
11500401

25 Pcs.



**11909PK** 10-1.50mm Screw Size  
15mm Hex Size  
24mm Outside Diameter Loose Washer  
Black Finish  
Metric Hex Nuts  
Chrysler # 6100053  
Ford # N621942-S301, N621942-S441,  
N621942-S2

25 Pcs.



## Nuts Short Type "J"

**10053PK** #6 (3.50mm) Screw Size  
.090 - .110" Panel Range  
9/32" Center of Hole to Edge  
Black Finish  
Short Type "J" Nuts

25 Pcs.



## Nuts Speed Type "U" for Sheet Metal Screws

**9892PK** #6 (3.50mm) Screw Size  
.025 - .125" Panel Range  
3/8" Center of Hole to Edge  
Black Finish  
Speed Type "U" Nuts

50 Pcs.

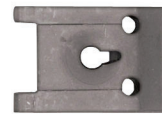

**1350PK** #8 (4.20mm) Screw Size  
.020 - .150" Panel Range  
3/8" Center of Hole to Edge  
Black Finish  
Speed Type "U" Nuts  
Ford # 381818-S2, 15650655  
G.M. # 9424837, 9431530, 15650655

100 Pcs.

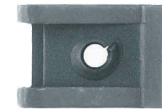

**11136PK** #8 (4.20mm) Screw Size  
.025 - .125" Panel Range  
3/8" Center of Hole to Edge  
Black Finish  
Speed Type "U" Nuts

25 Pcs.

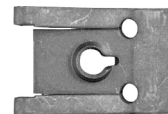

**5750PK** #8 (4.20mm) Screw Size  
.025 - .150" Panel Range  
5/8" Center of Hole to Edge  
Black Finish  
Speed Type "U" Nuts  
Ford # 381863-S2  
G.M. # 9440178, 9433155, 11504531

100 Pcs.

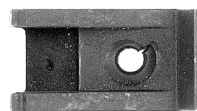

**11040PK** #8 (4.20mm) Screw Size  
.045 - .062" Panel Range  
3/8" Center Of Hole To Edge  
Black Finish  
Speed Type "U" Nuts  
G.M. # 445429, 9422552

50 Pcs.



**13350PK** #8 (4.20mm) Screw Size  
.50 - 2.50mm Panel Range  
14mm Center Of Hole To Edge  
Zinc Finish  
Speed Type "U" Nuts  
Mercedes # 123-994-08-45

25 Pcs.



**1510PK** #8 (4.20mm) Screw Size  
.125 - .250" Panel Range  
3/8" Center of Hole to Edge  
Black Finish  
Speed Type "U" Nuts  
G.M. # 9433156











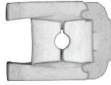



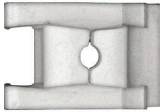



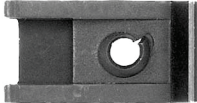

100 Pcs.

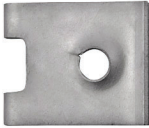

5

# Specialty Nuts









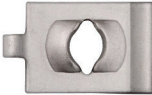

## Nuts Speed Type "U" for Sheet Metal Screws

<b>16076PK</b>	#8 (4.20mm) Screw Size 2.00 - 3.40mm Panel Range 9.50mm Center of Hole to Edge Zinc Organic Finish Metric "U" Nuts Ford # W708991-S439	<b>25 Pcs.</b>		 <b>NEW!</b>
<b>11954PK</b>	#8 (4.20mm) Screw Size 3 - 4mm Panel Range 7mm Center of Hole to Edge Zinc Finish Speed Type "U" Nuts BMW # 0712-9-925-708 Mercedes # 000-994-25-45	<b>50 Pcs.</b>		
<b>18795PK</b>	#8 (4.20-1.41mm) Screw Size 0.50 - 1.80mm Panel Range 7.92mm Center of Hole to Edge Zinc Finish Bumper Cover & Wheel Moulding U-Nuts Ford # W704277-S496	<b>25 Pcs.</b>		 <b>NEW!</b>
<b>5751PK</b>	#10 (4.80mm) Screw Size .025 - .150" Panel Range 11/32" Center of Hole to Edge Black Finish Speed Type "U" Nuts	<b>25 Pcs.</b>		
<b>5752PK</b>	#10 (4.80mm) Screw Size .025 - .150" Panel Range 19/32" Center of Hole to Edge Black Finish Speed Type "U" Nuts	<b>50 Pcs.</b>		
<b>11286PK</b>	#10 (4.80mm) Screw Size .50 - 1.70mm Panel Range 7mm Center of Hole to Edge Zinc Finish Speed Type "U" Nuts BMW # 0712-9-925-737, 07-12-9-901-651 Mercedes # 000-994-06-45, 003-994-30-45	<b>50 Pcs.</b>		
<b>13301PK</b>	#10 (4.80mm) Screw Size .80 - 1.70mm Panel Range 11mm Center of Hole to Edge Zinc Finish Speed Type "U" Nuts BMW # 0711-9-916-945, 07-11-9-901-294, 07-11-9-901-299 Mercedes # 000-994-14-45	<b>50 Pcs.</b>		
<b>11915PK</b>	#10 (4.80mm) Screw Size .90 - 2mm Panel Range 8mm Center of Hole to Edge Zinc Finish Speed Type "U" Nuts Mercedes # 000-994-14-45	<b>25 Pcs.</b>		
<b>13434PK</b>	#10 (4.80mm) Screw Size 2.30 - 3.50mm Panel Range 8.50mm Center of Hole to Edge Zinc Finish Speed Type "U" Nuts BMW # 07129904150	<b>25 Pcs.</b>		
<b>17089PK</b>	5 - 1.81mm Screw Size 2.00 - 3.50mm Panel Range 8.00mm Center of Hole to Edge Zinc Finish "U" Nuts Use With # 10246 Acura # 90331-S3Y-003 Honda # 90331-S3Y-003	<b>50 Pcs.</b>		 <b>NEW!</b>

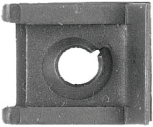
5

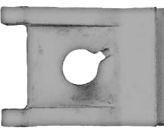

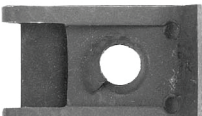



# Specialty Nuts

## Nuts Speed Type "U" for Sheet Metal Screws

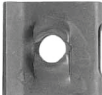

<b>10246PK</b>	5 - 1.81 x 20mm Phillips Flat Top 13mm Head Diameter Black Finish Trim Screws Honda 90103-SDA-A00, 90103-TA0-000	<b>100 Pcs.</b>		
<b>18881PK</b>	#14 (6-1.81mm) Screw Size 1.50mm Panel Range 10mm Center of Hole to Edge Zinc Finish Speed Type "U" Nuts Hyundai # 13355-06016 Kia # 13355-06016			
<b>1192PK</b>	#14 (6.30mm) Screw Size .025 - .150" Panel Range 3/8" Center of Hole to Edge Black Finish Speed Type "U" Nuts G.M. # 9431532	<b>25 Pcs.</b>		
<b>11128PK</b>	#14 (6.30mm) Screw Size .025 - .150" Panel Range 3/8" Center of Hole to Edge Zinc Organic Finish Speed Type "U" Nuts Nissan # 08967-1065A	<b>25 Pcs.</b>		
<b>5753PK</b>	#14 (6.30mm) Screw Size .025 - .150" Panel Range 5/8" Center of Hole to Edge Black Finish Speed Type "U" Nuts	<b>25 Pcs.</b>		

5

## Nuts Speed Type "U" for Machine Screws

<b>9866PK</b>	8-32 Screw Size .110 - .125" Panel Range 9/32" Center of Hole to Edge Black Finish Speed Type "U" Nuts	<b>25 Pcs.</b>		
<b>9897PK</b>	10-24 Screw Size .045 - .062" Panel Range 17/32" Center of Hole to Edge Black Finish Speed Type "U" Nuts	<b>100 Pcs.</b>		
<b>9848PK</b>	1/4-20 Screw Size .064 - .125" Panel Range 9/16" Center of Hole to Edge Black Finish Speed Type "U" Nuts G.M. # 9431647, 22529733	<b>100 Pcs.</b>		

## Nuts Extruded Type "U" Standard

<b>938PK</b>	10-24 Screw Size .025 - .125" Panel Range 15/32" Center of Hole to Edge Black Finish Extruded "U" Nuts Chrysler # 149251 G.M. # 152273	<b>50 Pcs.</b>		
<b>938ZPK</b>	10-24 Screw Size .025 - .125" Panel Range 15/32" Center of Hole to Edge Bright Zinc Finish Extruded "U" Nuts	<b>50 Pcs.</b>		

# Specialty Nuts

## Nuts Extruded Type "U" Standard

<b>2969PK</b>	1/4-20 Screw Size .010 - .165" Panel Range 17/32" Center of Hole to Edge Black Finish Extruded "U" Nuts Ford # 45263-S2 G.M. # 1494252, 1480627	25 Pcs.		
<b>2969ZYPK</b>	1/4-20 Screw Size .010 - .165" Panel Range 17/32" Center of Hole to Edge Yellow Zinc Finish Extruded "U" Nuts	25 Pcs.		
<b>5480PK</b>	1/4-20 Screw Size .010 - .165" Panel Range 25/32" Center of Hole to Edge Black Finish Extruded "U" Nuts Ford # 45267 G.M. # 1494257	25 Pcs.		
<b>1835PK</b>	5/16-18 Screw Size .025 - .125" Panel Range 5/8" Center of Hole to Edge Black Finish Extruded "U" Nuts Chrysler # 6023171 Ford # 45264 G.M. # 1494253	25 Pcs.		
<b>1836PK</b>	5/16-18 Screw Size .010 - .170" Panel Range 27/32" Center of Hole to Edge Black Finish Extruded "U" Nuts Ford # 379831-S G.M. # 1494258, 10008002, 12338146, 45268-S2	25 Pcs.		
<b>5412PK</b>	3/8-16 Screw Size .035 - .205" Panel Range 3/4" Center of Hole to Edge Black Finish Extruded "U" Nuts Ford # 45265-S2 G.M. # 1494254, 12337873	25 Pcs.		
<b>5466PK</b>	3/8-16 Screw Size .035 - .220" Panel Range 1 1/8" Center of Hole to Edge Black Finish Extruded "U" Nuts Ford # 45269, 45269-S	25 Pcs.		
			Not Actual Size	
<b>16095PK</b>	6-1.00mm Screw Size .50mm - 4.00mm Panel Range 13mm Center of Hole to Edge Silver Finish Extruded "U" Nuts Chrysler # 6105242-AA	25 Pcs.		

## Hardware Skid Plate

<b>16990PK</b>	4.50mm Stud Size 13mm Center of Hole to Edge Zinc Finish Skid Plate "U" Nuts Use With # 16991 Audi # 8K0-805-922A	15 Pcs.		
----------------	----------------------------------------------------------------------------------------------------------------------------------	---------	--	--

# Specialty Nuts

## Hardware Skid Plate

### 16991PK

1 1/64" (4.50mm) Hole Size  
18.50mm Stem Length  
16mm Head Diameter  
Black Finish  
Phillips Drive Cowl Fasteners  
Use With #16990  
V.W. # 8KO-805-121

10 Pcs.



### 13254PK

6mm Stud Size  
12.20mm Center of Hole to Edge  
Zinc Finish  
Speed Type "U" Nuts For Nylon Screws  
Use With # 13253 & 1655  
V.W. # 8D0805960

10 Pcs.

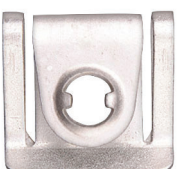

### 1655PK

8mm Bolt Size  
8.40mm Inside Diameter  
17mm Outside Diameter  
Bright Zinc Finish  
Metric Flat Washers  
Use With # 13253 & 13254

100 Pcs.



### 13253PK

9/32" (7mm) Hole Size  
20mm Stem Length  
18mm Head Diameter  
Black Finish Steel  
Slotted Drive Cowl Fasteners  
Use With # 13254 & 1655  
V.W. # 8D0-805-121B

10 Pcs.



## Nuts Splash Shield Retaining Metric

### 15730PK

5mm Stud Size  
30mm Outside Diameter Flange  
Dacromet Finish  
Splash Shield & Wheel Well  
Push Type Retainers  
V.W. # N90-335-006

25 Pcs.



### 13260PK

5-2.12x19mm  
14mm Head Diameter  
T25 Drive Size  
Black Finish  
Torx® Truss Head Screws  
Use with #10937 & 13256  
V.W. # N90892001, N90775001

25 Pcs.



### 10937PK

5mm Torx Screw Size  
30mm Outside Diameter Flange  
Zinc Finish  
Splash Shield Retainers  
Use with #13260 & 13256  
V.W. # N90-796-502, N90-335-004

25 Pcs.



### 13256PK

5-2.12 Screw Size  
8mm Stem Length  
7.50 x 13mm Hole Size  
Zinc Finish  
Splash Shield Retaining Nuts  
Use with # 13260 & 10937  
V.W. # N10327101, N10327102



25 Pcs.



# Specialty Nuts



## Nuts Splash Shield Retaining Metric



<b>17932PK</b>	14mm Hex Size 30mm Flange Diameter Black Nylon Wheel Well Liner & Splash Shield Nuts Hyundai # 84145-26000	<b>15 Pcs.</b>	 
----------------	---------------------------------------------------------------------------------------------------------------------------	----------------	------------------------------------------------------------------------------------------------------------------------------------------------------------------------

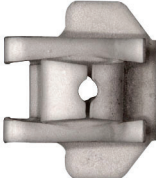

<b>15868PK</b>	8.50mmx11.00mm Hole Size 36mm Stem Length 18mm Head Diameter Black Nylon Rocker Panel & Splash Shield Screw Grommet With Specialty Screw Chrysler # 6510123AA	<b>5 Pcs.</b>	 
----------------	---------------------------------------------------------------------------------------------------------------------------------------------------------------------------------	---------------	------------------------------------------------------------------------------------------------------------------------------------------------------------------------

## Nuts Extruded Type "U" Metric

5



<b>11981PK</b>	#8 (4.20-1.41mm) Screw Size 9.50mm Center of Hole to Edge 1.80 - 3.50mm Panel Range Zinc Organic Extruded "U" Nuts Ford # W716567-S439	<b>25 Pcs.</b>	 
----------------	-------------------------------------------------------------------------------------------------------------------------------------------------------	----------------	------------------------------------------------------------------------------------------------------------------------------------------------------------------------



<b>16078PK</b>	#8 (4.20-1.41mm) Screw Size 9.50mm Center of Hole to Edge 2.00 - 3mm Panel Range Zinc Organic Prevailing Torque Extruded "U" Nuts G.M. # 11548579	<b>25 Pcs.</b>	 
----------------	------------------------------------------------------------------------------------------------------------------------------------------------------------------	----------------	--------------------------------------------------------------------------------------------------------------------------------------------------------------------------

<b>10726PK</b>	#8 (4.20-1.41mm) Screw Size 10mm Center of Hole to Edge .50 - 2.00mm Panel Range Zinc Organic Prevailing Torque Extruded "U" Nuts G.M. # 11516397 Ford # W707291-S439	<b>50 Pcs.</b>	 
----------------	-----------------------------------------------------------------------------------------------------------------------------------------------------------------------------------------	----------------	----------------------------------------------------------------------------------------------------------------------------------------------------------------------------

<b>11339PK</b>	#8 (4.20-1.41mm) Screw Size 10.10mm Center of Hole to Edge 2.00 - 3mm Panel Range Prevailing Torque 6.28 In-lbs Black Finish Extruded "U" Nuts G.M. # 11513700	<b>25 Pcs.</b>	 
----------------	----------------------------------------------------------------------------------------------------------------------------------------------------------------------------------	----------------	----------------------------------------------------------------------------------------------------------------------------------------------------------------------------



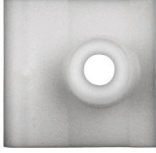







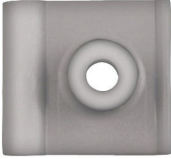

<b>11043PK</b>	#8 (4.20-1.41mm) Screw Size 15mm Center of Hole to Edge .65 - 3.80mm Panel Range Zinc Organic Prevailing Torque Extruded "U" Nuts G.M. # 11515638	<b>25 Pcs.</b>	 
----------------	------------------------------------------------------------------------------------------------------------------------------------------------------------------	----------------	----------------------------------------------------------------------------------------------------------------------------------------------------------------------------

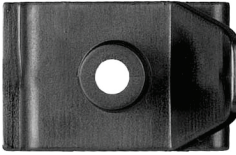
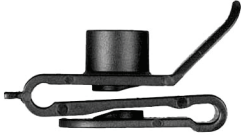
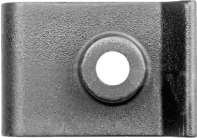
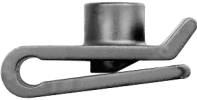
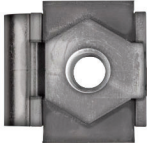
<b>1021PK</b>	4-.70mm Screw Size 13.50mm Center of Hole to Edge .80 - 4mm Panel Range Black Finish Extruded "U" Nuts G.M. # 11500655	<b>50 Pcs.</b>	 
---------------	---------------------------------------------------------------------------------------------------------------------------------------	----------------	----------------------------------------------------------------------------------------------------------------------------------------------------------------------------

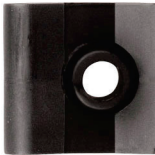
<b>12898PK</b>	#10 (4.80mm) Screw Size Up to 1.50mm Panel Range 8mm Center of Hole to Edge White Nylon "U" Type Nuts Nissan # 76882-0M000	<b>15 Pcs.</b>	 
----------------	-------------------------------------------------------------------------------------------------------------------------------------------	----------------	----------------------------------------------------------------------------------------------------------------------------------------------------------------------------









# Specialty Nuts

## Nuts Extruded Type "U" Metric

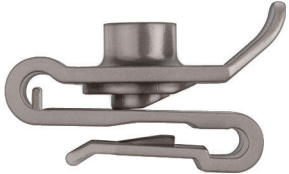

<b>15214PK</b>	#10 (4.80mm) Screw Size Up to 1.00mm Panel Range 11mm Center of Hole to Edge Gray Nylon "U" Type Nuts Mazda # B455-56-135	<b>25 Pcs.</b>		
<b>18105PK</b>	#10 (4.80mm) Screw Size Up to 1.00mm Panel Range 11mm Center of Hole to Edge Gray Nylon Front Bumper "U" Type Nuts Mazda # C274-50-133	<b>25 Pcs.</b>		
<b>1601PK</b>	#10 (4.80mm) Screw Size Up to 1.00mm Panel Range 11mm Center of Hole to Edge Black Nylon Fender Wheel Housing "U" Type Nuts G.M. # 94841226 Mazda LA01-56-135 Toyota # 53879-14010-A, 53879-14020, 53879-22030	<b>15 Pcs.</b>		
<b>12494PK</b>	#10 (4.80mm) Screw Size Up to 3mm Panel Range 14mm Center of Hole to Edge Black Nylon "U" Type Nuts Toyota # 90179-05060	<b>10 Pcs.</b>		
<b>17941PK</b>	5.00- .80mm Screw Size Panel Range Up to 3mm Center of Hole to Edge 10mm Black Nylon With Metal Insert Splash Guard "U" Nuts Subaru # 91086AA000	<b>10 Pcs.</b>		
<b>11161PK</b>	#12 (5.50mm) Screw Size Up to 1.00mm Panel Range 9mm Center of Hole to Edge Black Nylon "U" Type Nuts Nissan # 63848-D0100	<b>15 Pcs.</b>		
<b>9530PK</b>	#12 (5.50mm) Screw Size Up to 2mm Panel Range 9mm Center of Hole to Edge Black Nylon Inner Fender "U" Type Nuts Nissan # 63848-D4000, 63848D4001	<b>10 Pcs.</b>		
<b>15729PK</b>	#12 (5.50mm) Screw Size Up To 2mm Panel Range 12mm Center Of Hole to Edge Red Nylon "U" Type Nuts Use With # 10123 G.M. # 24449408	<b>25 Pcs.</b>		

# Specialty Nuts







## Nuts Extruded Type "U" Metric

<b>10123PK</b>	5.50 x 20mm Torx® Truss Head 15mm Outside Diameter Washer Black Zinc Finish Screws Use With # 15729 G.M. # 13144822	<b>25 Pcs.</b>		
<b>11421PK</b>	#12 (5.50mm) Screw Size Up to 1.00mm Panel Range 14mm Center of Hole to Edge Black Nylon "U" Type Nuts Toyota # 90467-05114	<b>10 Pcs.</b>		
<b>1012PK</b>	5-.80mm Screw Size 8mm Center of Hole to Edge .80 - 4mm Panel Range Black Finish Extruded "U" Nuts G.M. # 11500657, 11504693	<b>50 Pcs.</b>		
<b>12893PK</b>	5-.80mm Screw Size 11mm Center of Hole to Edge .60 - 3.80mm Panel Range Black Finish Extruded "U" Nuts Ford # N623331-S2, W520821-S439, W520821-S426 G.M. # 11505596, 11500656	<b>50 Pcs.</b>		
<b>18893PK</b>	6-1.00 Screw Size 1.50mm Panel Range 8mm Center of Hole to Edge Black Finish Bumper Cover Extruded 'U' Nuts Hyundai # 13341-06007-B Kia # 13341-06007-B	<b>25 Pcs.</b>		

## Nuts Nylon "U" Type with Metal Insert Metric

<b>16369PK</b>	6-1.00 Screw Size 3.50mm Panel Range 13.50mm Center of Hole to Edge Black Nylon & Black Metal License Plate Bracket "U" Nuts	<b>25 Pcs.</b>		
----------------	------------------------------------------------------------------------------------------------------------------------------------------	----------------	--------------------------------------------------------------------------------------	---------------------------------------------------------------------------------------



















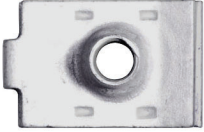

## Nuts Extruded Type "U" Metric

<b>16400PK</b>	6-1.00mm Screw Size 9mm Center of Hole to Edge 1.80 - 2.50mm Panel Range Zinc Finish Extruded "U" Nuts Ford # N806728-S439 G.M. # 11517841	<b>15 Pcs.</b>		
<b>16365PK</b>	6-1.00 Screw Size 9.20mm Center of Hole to Edge 1.80 - 2.20mm Panel Range Zinc Organic Extruded "U" Nuts Chrysler # 68073566AA	<b>15 Pcs.</b>		
<b>16328PK</b>	6-1.00 Screw Size 12mm Center of Hole to Edge .70 - 2.00mm Panel Range Zinc Finish Extruded "U" Nuts Ford # W712324-S439	<b>10 Pcs.</b>		

5

# Specialty Nuts

## Nuts Extruded Type "U" Metric

<b>16079PK</b>	6-1.00mm Screw Size 13.50mm Center of Hole to Edge .80 - 4.00mm Panel Range Zinc Organic Extruded U Nuts Ford # W520822-S439 Chrysler # 6510185-AA, 6101956, 6503694	25 Pcs.		
<b>10836PK</b>	6-1.00mm Screw Size 13.50mm Center of Hole to Edge .80 - 4.00mm Panel Range Black Phosphate Organic Finish Prevailing Torque Extruded "U" Nuts Chrysler # 6101308 Ford # N800854-S1 G.M. # 11509005	25 Pcs.		
<b>5596PK</b>	6-1.00mm Screw Size 13.50mm Center of Hole to Edge .80 - 4.00mm Panel Range Black Finish Extruded "U" Nuts Ford # N623332, N623332-S2, N623332-S53, N623332-S100 G.M. # 11503957, 11503716, 1016937	25 Pcs.		
<b>9512PK</b>	6-1.00mm Screw Size 13.50mm Center of Hole to Edge 3.40 - 6.30mm Panel Range Black Finish Extruded "U" Nuts Ford # N802331-S53 G.M. # 11504047	25 Pcs.		
<b>9949PK</b>	6-1.00mm Screw Size 14mm Center of Hole to Edge .50 - 2.30mm Panel Range GM 4435-M Finish Prevailing Torque Extruded "U" Nuts G.M.	25 Pcs.		
<b>16081PK</b>	6-1.00mm Screw Size 14mm Center of Hole to Edge .70 - 2.00mm Panel Range Zinc Organic Extruded "U" Nuts G.M. # 11611321	10 Pcs.		
<b>11030PK</b>	6-1.00mm Screw Size 14mm Center of Hole to Edge .80 - 2.00mm Panel Range Zinc Organic Extruded "U" Nuts G.M. # 11570097	15 Pcs.		
<b>16471PK</b>	6-1.00mm Screw Size 14.50mm Center of Hole to Edge .50 - 2.30mm Panel Range Zinc Organic Extruded "U" Nuts Ford # W705958-S439	10 Pcs.		
<b>13432PK</b>	6-1.00mm Screw Size 14.50mm Center of Hole to Edge 2.00 - 4.00mm Panel Range Zinc Finish Extruded "U" Nuts Honda # 90675-SA5-003	25 Pcs.		
<b>5650PK</b>	6-1.00mm Screw Size 19.50mm Center of Hole to Edge 1.00 - 2.50mm Panel Range Black Finish Extruded "U" Nuts Ford # W520832-S424, W520832-S426 G.M. # 11503715, 11506099, 11508241	25 Pcs.		

# Specialty Nuts

## Nuts Extruded Type "U" Metric

5559PK	6.3-1.00mm Screw Size 13.50mm Center of Hole to Edge .80 - 4.00mm Panel Range Black Finish Extruded "U" Nuts G.M. # 11500658, 9433043, 11502785	25 Pcs.		
10785PK	#14 (6.30mm) Screw Size 8mm Center of Hole to Edge Up to 1.50mm Panel Range Black Nylon Wheel Guard "U" Type Nuts Hyundai # 86825-28800	25 Pcs.		
11388PK	#14 (6.30mm) Screw Size 12mm Center of Hole to Edge Up to 2mm Panel Range Dark Red Nylon Front Bumper "U" Type Nuts Toyota # 90467-A0018, 90467-05081, 90084-46019	15 Pcs.		
15083PK	#14 (6.30mm) Screw Size Up to 3mm Panel Range 14mm Center of Hole to Edge Black Nylon Front Bumper & Fender Liner "U" Type Nuts Toyota # 90467-05138	15 Pcs.		
Not Actual Size				
1606PK	#14 (6.30mm) Screw Size Up to 1.00mm Panel Range 15mm Center of Hole to Edge Black Nylon Fender Wheel Housing "U" Type Nuts Toyota # 53879-22010	15 Pcs.		
16075PK	8-1.25mm Screw Size .80 - 4.00mm Panel Range 14.5mm Center of Hole to Edge Zinc Finish Extruded "U" Nuts Ford # W520823-S439, N800296-S439	15 Pcs.		
5560PK	8-1.25mm Screw Size 14.50mm Center of Hole to Edge .80 - 4.00mm Panel Range Black Finish Extruded "U" Nuts Chrysler # 6100042, 6101283 Ford # N623333-S2, N623333-S100 G.M. # 11500660, 11508925, 11502617	25 Pcs.		
5557PK	8-1.25mm Screw Size 20mm Center of Hole to Edge .80 - 4.50mm Panel Range Black Finish Extruded "U" Nuts Ford # N623343-S100, N623343-S2 G.M. # 11500661, 11503317, 11516150	25 Pcs.		
16080PK	8-1.25 Screw Size 21mm Center of Hole to Edge .80 - 4.00mm Panel Range Zinc Organic Extruded "U" Nuts Ford # W520813-S439 G.M. # 11516150	15 Pcs.		

# Specialty Nuts

## Nuts Extruded Type "U" Metric

<b>16099PK</b>	8-1.25mm Screw Size 3mm Panel Range 27.30mm Center of Hole to Edge Silver Magni Finish Fender Panel Extruded "U" Nuts G.M. # 11569971	<b>5 Pcs.</b>		
			Not Actual Size	
<b>5558PK</b>	10-1.50mm Screw Size 19mm Center of Hole to Edge .90 - 6.00mm Panel Range Black Finish Extruded "U" Nuts G.M. # 11500662, 22531616	<b>25 Pcs.</b>		

## Retainers Grommets

<b>16380PK</b>	2.50mm Stud Size 8mm Head Diameter 6mm Hole Size Clear Nylon With Sealer Emblem Tubular Nuts Mazda # LA01-51-958	<b>25 Pcs.</b>		
----------------	---------------------------------------------------------------------------------------------------------------------------------	----------------	--	--



















5

## Nuts Nylon

<b>9665PK</b>	#4 (2.80mm) Screw Size 16mm Stem Length 12mm Head Diameter 7.00 x 7.00mm Square Hole White Nylon With Sealer Screw Grommets Nissan # 01281-01121	<b>10 Pcs.</b>		
<b>11414PK</b>	#4 (2.90mm) Screw Size 7mm Stem Length 13mm Head Size 8.40 x 8.60mm Hole Size Natural Nylon Door Trim Grommets Honda # 90866-SA0-000	<b>25 Pcs.</b>		
<b>12634PK</b>	#4 (2.90mm) Screw Size 14mm Stem Length 9mm Head Size 7mm Hole Size Natural Nylon Side Moulding Screw Grommets Lexus # 90189-04207	<b>25 Pcs.</b>		
<b>2157PK</b>	#4 (2.90mm) Screw Size 17mm Stem Length 13mm Head Diameter 7mm Hole Size Natural Nylon Center Pillar Screw Grommets Honda # 91620-SR2-003	<b>10 Pcs.</b>		
<b>11193PK</b>	#6 (3.50mm) Screw Size 6.50mm Stem Length 9.60mm Head Size 6.00 x 6.50mm Hole Size Natural Nylon With Sealer Rear Bumper Grommets G.M. # 11589183	<b>50 Pcs.</b>		
<b>16473PK</b>	#6 (3.50mm) Screw Size 7mm Stem Length 10mm Head Size 7.00 x 7.00mm Hole Size White Nylon Screw Grommets Toyota # 81137-22530, 90075-10004, 81150-1A750	<b>25 Pcs.</b>		

# Specialty Nuts





## Nuts Nylon

10808PK	#6 (3.50mm) Screw Size 7mm Stem Length 12.00 x 18.00mm Head Size 6.00 x 14.00mm Hole Size White Nylon Rocker Trim Screw Grommets Lexus # 90189-04059	25 Pcs.		
1297PK	#6 (3.50mm) Screw Size 5/16" Stem Length 13/32" Head Size 9/32" Hole Size Natural Nylon Headlight Screw Grommets Chrysler # 6029501 G.M. # 1370853 V.W. # 179-813-883, 155-809-966	50 Pcs.		
9112PK	#6 (3.50mm) Screw Size 8mm Stem Length 12mm Head Size 7.00 x 7.50mm Hole Size Natural Nylon Screw Grommets Toyota # 90189-04011, 90189-04057	25 Pcs.		
1978PK	#6 (3.50mm) Screw Size 8mm Stem Length 12.00 x 16.00mm Head Size 6.00 x 10.00mm Hole Size Natural Nylon Screw Grommets Isuzu # 8941340270 Toyota # 90189-05012	50 Pcs.		
9873PK	#6 (3.50mm) Screw Size 8mm Stem Length 12.50mm Head Diameter 7.00 x 7.50mm Hole Size Natural Nylon Headlight Door to Radiator Grille Grommets G.M. # 1355003	50 Pcs.		
1227PK	#6 (3.50mm) Screw Size 8.50mm Stem Length 9.00 x 13.00mm Head Size 6.50 x 9.00mm Hole Size Black Nylon Front Fender Screw Grommets Ford # N-800503S	50 Pcs.		
9111PK	#6 (3.50mm) Screw Size 8.50mm Stem Length 10mm Head Size 6.50 x 7.50mm Hole Size Natural Nylon Headlight Screw Grommets AMC # 400141 G.M. # 380382 Mitsubishi # MS480001	50 Pcs.		
1202PK	#6 (3.50mm) Screw Size 8.50mm Stem Length 13.00 x 17.00mm Head Size 7.00 x 15.00mm Hole Size Natural Nylon Grille Attachment Screw Grommets G.M. # 14032291	50 Pcs.		
637PK	#6 (3.50mm) Screw Size 9mm Stem Length 14.00 x 21.00mm Head Size 7.00 x 18.50mm Hole Size Natural Nylon Rear Bumper Bar Screw Grommets G.M. # 1377030	100 Pcs.		

5

# Specialty Nuts





## Nuts Nylon

<b>9085PK</b>	#6 (3.50mm) Screw Size 3/8" Stem Length 15/64 x 23/64" Head Size 15/64" Hole Size White Nylon Marker Light Screw Grommets G.M. # 1254815	<b>50 Pcs.</b>		
<b>15148PK</b>	#6 (3.50mm) Screw Size 9.50mm Stem Length 11.50mm Head Diameter 7mm Hole Size Natural Nylon Screw Grommets Nissan # 96706-H2500	<b>25 Pcs.</b>		
<b>11147PK</b>	#6 (3.50mm) Screw Size 10mm Stem Length 12mm Head Diameter 6.60mm Hole Size Gray Nylon With Sealer Rear Hatch Screw Grommets Acura # 91601-STX-A00	<b>10 Pcs.</b>		
<b>9591PK</b>	#6 (3.50mm) Screw Size 10mm Stem Length 14mm Head Diameter 7mm Hole Size Natural Nylon With Sealer Screw Grommets Honda # 90662-693-0030, 90662-693-003, 90662-693-0031 Toyota # 90189-04066	<b>25 Pcs.</b>		
<b>17939PK</b>	#6 (3.50mm) Screw Size 12mm Stem Length 8.00 x 10.00mm Head Size White Nylon Bumper Grommet Hyundai # 86518-3M000	<b>25 Pcs.</b>		
<b>10619PK</b>	#6 (3.50mm) Screw Size 12mm Stem Length 12.00 x 16.00mm Head Size Blue Nylon With Sealer Windshield Moulding Grommets Nissan # 76848-50Y00	<b>10 Pcs.</b>		
<b>13344PK</b>	#6 (3.50mm) Screw Size 14mm Stem Length 9.50mm Head Size 6.50 x 7.00mm Hole Size Black Nylon Cowl Vent Nuts Mercedes # 639-998-01-85 Replaces # 000-988-16-25	<b>25 Pcs.</b>		
<b>1636PK</b>	#6 (3.50mm) Screw Size 15mm Stem Length 14.50mm Head Diameter 7mm Hole Size Natural Nylon Screw Grommets Honda # 90672-671-8110M1 Toyota # 90189-04013	<b>25 Pcs.</b>		
<b>10715PK</b>	#6 (3.50mm) Screw Size 16mm Stem Length 22.00 x 23.50mm Head Size 15mm Hole Size Black Nylon Headlight Screw Grommets Ford # W712160-S300	<b>15 Pcs.</b>		



5

# Specialty Nuts











## Nuts Nylon

<b>2156PK</b>	#6 (3.50mm) Screw Size 16.50mm Stem Length 8mm Head Size 7mm Hole Size Natural Nylon With Sealer Body Side Screw Grommets Nissan # 01281-00501	<b>15 Pcs.</b>		
<b>1407PK</b>	#6 (3.50mm) Screw Size 16.50mm Stem Length 14.70 x 20.80mm Head Size 7.10 x 20.30mm Hole Size Black Nylon High Torque Screw Grommets AMC # 8934-201-602 Chrysler # 6031869 G.M. # 10032838, 1264963	<b>25 Pcs.</b>		

## Retainers Grommets

<b>16359PK</b>	4mm Screw Size 11/32" (8.50mm) Hole Size 9.70mm Stem Length 9.50mm Flange Diameter Gray Nylon With Sealer Screw Grommets Honda # 90656-SJK-J01	<b>15 Pcs.</b>		
----------------	------------------------------------------------------------------------------------------------------------------------------------------------------------------	----------------	------------------------------------------------------------------------------------	-------------------------------------------------------------------------------------

















## Nuts Nylon

<b>11863PK</b>	#6 to #8 Screw Size 8.30mm Stem Length 11.00 x 13.60mm Head Size Black Nylon Cowl Vent Nuts Chrysler # 6035274 G.M. # 15596280	<b>25 Pcs.</b>		
<b>18794PK</b>	#8 (4.20mm) Screw Size 5mm Stem Length 12.75mm Head Diameter 7.87mm Square Hole Size White Nylon Grille Trim Screw Grommets Ford # W711612-S300	<b>25 Pcs.</b>		
<b>11185PK</b>	#8 (4.20mm) Screw Size 5mm Stem Length 15mm Head Diameter 8mm Hole Size Gray Nylon Rear Bumper Fascia Grommets Honda # 90651-SL9-013, 90651-SL9-0130	<b>15 Pcs.</b>		
<b>10993PK</b>	#8 (4.20mm) Screw Size 6.40mm Stem Length 10.00 x 16.00mm Head Size 7.00 x 11.40mm Hole Size Black Nylon Front Fascia Grommets Honda # 90107-SOX-A01	<b>15 Pcs.</b>		
<b>15038PK</b>	#8 (4.20mm) Screw Size 6.50mm Stem Length 9.50mm Head Size 7.00 x 7.00mm Hole Size Black Nylon Side Marker Light Screw Grommet Honda # 75522-611-000 Mazda # 9991-00-412 Mitsubishi # MS-480001	<b>50 Pcs.</b>		

5



# Specialty Nuts

## Nuts Nylon

<b>1577PK</b>	#8 (4.20mm) Screw Size 6.50mm Stem Length 10mm Head Size 6.00 x 7.00mm Hole Size Natural Nylon Side Marker Light Screw Grommets Honda # 75522-611-000, 75522-611-0000 Mazda # 9991-00-412 Mitsubishi # MS-480001 Nissan # 96706-B0700, 97606-B0700 Toyota # 90189-04042, 95900-04036	<b>50 Pcs.</b>		
<b>2940PK</b>	#8 (4.20mm) Screw Size 17/64" Stem Length 31/64" Head Size 5/16" Hole Size Natural Nylon Headlamp Screw Grommets G.M. # 14013246	<b>50 Pcs.</b>		
<b>9050PK</b>	#8 (4.20mm) Screw Size 17/64" Stem Length 17/32" Head Size 11/32" Hole Size Natural Nylon Grille Screw Grommets G.M.	<b>50 Pcs.</b>		
<b>12902PK</b>	#8 (4.20mm) Screw Size 7mm Stem Length 10mm Head Size 7mm Hole Size Natural Nylon Screw Grommets Toyota # 90189-04014	<b>50 Pcs.</b>		
<b>1574PK</b>	#8 (4.20mm) Screw Size 9/32" Stem Length 7/16" Head Size 5/16" Hole Size Natural Nylon Grille Screw Grommets G.M. # 3919773, 22649878, 22649879	<b>100 Pcs.</b>		
<b>2980PK</b>	#8 (4.20mm) Screw Size 9/32" Stem Length 7/16" Head Size 5/16" Hole Size Natural Nylon Grille Screw Grommets G.M. # 3893980, 347347	<b>50 Pcs.</b>		
<b>1997PK</b>	#8 (4.20mm) Screw Size 8mm Stem Length 13mm Head Diameter 7.50mm Hole Size Black Nylon Tail Light Screw Grommets G.M. # 3997391 V.W. # 179-813-881	<b>25 Pcs.</b>		
<b>11143PK</b>	#8 (4.20mm) Screw Size 8mm Stem Length 17mm Head Diameter 9mm Hole Size Natural Nylon Headlight Mounting Nuts Toyota # 90189-05142	<b>25 Pcs.</b>		

5

## Retainers Grommets

<b>16399PK</b>	23/64" (9mm) Hole Size 8mm Stem Length 17mm Head Diameter Yellow Nylon Headlamp Assembly Grommets Toyota # 90189-06238	<b>25 Pcs.</b>		
----------------	---------------------------------------------------------------------------------------------------------------------------------------	----------------	---------------------------------------------------------------------------------------	---------------------------------------------------------------------------------------

# Specialty Nuts



















## Nuts Nylon

12667PK	#8 (4.20mm) Screw Size 8.50mm Stem Length 9.70mm Head Diameter 6.50 x 7.50mm Hole Size Natural Nylon With Sealer Screw Grommets G.M. # 9669486 Renault # 8934-201-262	25 Pcs.		
9113PK	#8 (4.20mm) Screw Size 9mm Stem Length 10mm Head Size 7mm Hole Size Natural Nylon Radiator Grille Screw Grommets Chrysler # 6000943 Renault # 8934-201-263	100 Pcs.		
12465PK	#8 (4.20mm) Screw Size 9.50mm Head Size 6mm Hole Size White Nylon Screw Grommets Honda # 34301-692A-0000	50 Pcs.		
9683PK	#8 (4.20mm) Screw Size 9mm Stem Length 12.00 x 12.00mm Square Head 10mm Hole Size Natural Nylon Door Handle Nuts Hyundai # 14910-05000	25 Pcs.		
11898PK	#8 (4.20mm) Screw Size 10mm Stem Length 12.50 x 14.50mm Head Size Black Nylon Radiator Grille Nuts Chrysler # 6031234	25 Pcs.		
10783PK	#8 (4.20mm) Screw Size 10mm Stem Length 14mm Head Size 8.00 x 12.00mm Hole Size White Nylon With Sealer Body Moulding Screw Grommets Hyundai #87756-3D000	15 Pcs.		
10922PK	#8 (4.20mm) Screw Size 10mm Stem Length 14.50 x 16.70mm Head Size Maroon Nylon Scuff Plate Screw Grommets V.W. # 1J0-853-120	15 Pcs.		
10636PK	#8 (4.20mm) Screw Size 10mm Stem Length 16mm Head Diameter 8.50mm Hole Size Natural Nylon Screw Grommets	25 Pcs.		
9688PK	#8 (4.20mm) Screw Size 10mm Stem Length 16mm Head Diameter 9mm Hole Size Natural Nylon Bumper, Fender & Light Screw Grommets Nissan # 01281-00831	25 Pcs.		

5

# Specialty Nuts

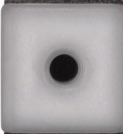













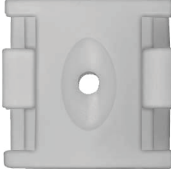
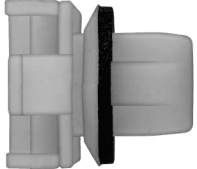

## Nuts Nylon

<b>18856PK</b>	#8 (4.20mm) Screw Size 10mm Stem length 16mm Head Diameter 9mm Hole Size Black Nylon Door Trim Panel Screw Grommets Chrysler # 6035401	<b>25 Pcs.</b>		
<b>10548PK</b>	#8 (4.20mm) Screw Size 10mm Stem Length 16mm Head Size 9mm Hole Size Natural Nylon Door Trim Panel Screw Grommets Chrysler # 6035401	<b>25 Pcs.</b>		
<b>10668PK</b>	#8 (4.20mm) Screw Size 3/8" Stem Length 5/8" Head Size 1 1/32" Hole Size Tan Nylon With Sealer Tail Light Screw Grommets Chrysler # 6505703AA	<b>15 Pcs.</b>		
<b>12021PK</b>	#8 (4.20mm) Screw Size 1 3/32" Stem Length 3/8" Head Size Black Nylon Screw Grommets Chrysler # 6033677 Ford # 379830-S, 383356-S	<b>25 Pcs.</b>		
<b>1842PK</b>	#8 (4.20mm) Screw Size 1 3/32" Stem Length 3/8" Head Size 1/4" Hole Size Natural Nylon Grille Screw Grommets Ford # 379830-S	<b>50 Pcs.</b>		
<b>10553PK</b>	#8 (4.20mm) Screw Size 1 3/32" Stem Length 1/2" x 2 1/32" Head Size 19/64" x 15/32" Hole Size Black Nylon Door Panel & Fender Shield Screw Grommets Chrysler # 6035821 G.M. # 11517759	<b>25 Pcs.</b>		
<b>10918PK</b>	#8 (4.20mm) Screw Size 11mm Stem Length 7.00 x 12.00mm Head Size 7mm Hole Size Black Nylon Inside Fender Screw Grommets V.W. # 811-807-577C	<b>25 Pcs.</b>		
<b>10556PK</b>	#8 (4.20mm) Screw Size 11mm Stem Length 10mm Head Size 6.70mm Hole Size Natural Nylon Door Reveal Screw Grommets Ford # W710362 G.M. # 25647358	<b>25 Pcs.</b>		
<b>9681PK</b>	#8 (4.20mm) Screw Size 12mm Stem Length 11.50mm Hole Size Gray Nylon With Sealer Trim Moulding Grommets Hyundai # 87759-3S000	<b>10 Pcs.</b>		

5





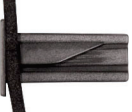







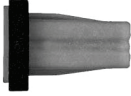

# Specialty Nuts

## Nuts Nylon

<b>11264PK</b>	#8 (4.20mm) Screw Size 12mm Stem Length 20mm Head Diameter 9mm Hole Size Black Nylon Fender Apron Grommets Honda # 90682-SEA-003	<b>25 Pcs.</b>		
<b>15308PK</b>	#8 (4.20mm) Screw Size 13mm Stem Length 11mm Head Diameter 6.50 x 8.00mm Hole Size Natural Nylon Screw Grommets V.W. # 165-827-592	<b>25 Pcs.</b>		
<b>12478PK</b>	#8 (4.20mm) Screw Size 13mm Stem Length 15mm Head Diameter Black Nylon Fender Apron Screw Grommet V.W. # N908-338-01	<b>15 Pcs.</b>		
<b>10384PK</b>	#8 (4.20mm) Screw Size 13mm Stem Length 23.20mm Square Head Size 10.00 x 14.00mm Hole Size White Nylon Cowl Vent Grommets Ford # N807189-S100, N811353-S100	<b>10 Pcs.</b>		
<b>10779PK</b>	#8 (4.20mm) Screw Size 14mm Stem Length 16.70mm Head Size 8.00 x 10.00mm Hole Size White Nylon With Sealer Rocker Moulding Screw Grommets Hyundai #87758-37000	<b>25 Pcs.</b>		
<b>10617PK</b>	#8 (4.20mm) Screw Size 14mm Stem Length 20 x 28mm Head Size 7.50 x 12mm Hole Size Natural Nylon Bumper Screw Grommets Nissan # 71144-SR3-A00	<b>25 Pcs.</b>		
<b>11281PK</b>	#8 (4.20mm) Screw Size 15mm Stem Length 15mm Head Diameter 8mm Hole Size Natural Nylon With Sealer Screw Grommets Honda # 90664-SB3-003	<b>10 Pcs.</b>		
<b>9659PK</b>	#8 (4.20mm) Screw Size 15mm Stem Length 20mm Head Diameter White Nylon Screw Grommets Mazda # GJ6A-58-975	<b>10 Pcs.</b>		
<b>18825PK</b>	4.2-1.41 Screw Size 16mm Stem Length 10.20mm Head Size Black Nylon Roof Lamp Grommets Chrysler # 68224180AC	<b>25 Pcs.</b>		

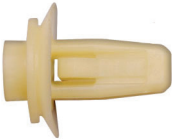
# Specialty Nuts













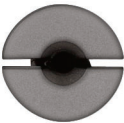

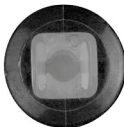
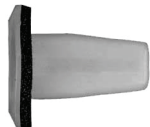

## Nuts Nylon

<b>11028PK</b>	#8 (4.20mm) Screw Size 15mm Stem Length 20mm Head Diameter 10mm Hole Size Natural Nylon With Sealer Rocker Moulding Screw Grommets Nissan # 01281-00711	<b>10 Pcs.</b>		
<b>11202PK</b>	#8 (4.20mm) Screw Size 16mm Stem Length 12mm Head Size 7mm Hole Size Natural Nylon With Sealer Bumper Cover Grommets G.M. # 11561847	<b>25 Pcs.</b>		
<b>10658PK</b>	#8 (4.20mm) Screw Size 16mm Stem Length 12mm Head Diameter 7mm Hole Size Natural Nylon With Sealer Door Panel Screw Grommets Honda # 90370-SG0-003, 91626-SH3-003	<b>15 Pcs.</b>		
<b>12725PK</b>	#8 (4.20mm) Screw Size 16mm Stem Length 12mm Head Size 10mm Hole Size Black Nylon Screw Grommets Mitsubishi # MB029111 Toyota # 90189-04008, 90467-12096, 94841130	<b>15 Pcs.</b>		
<b>10772PK</b>	#8 (4.20mm) Screw Size 16mm Stem Length 17.00 x 25.00mm Head Size 8.00 x 10.00mm Hole Size Yellow Nylon With Sealer Trim Screw Grommets Hyundai #87759-27000	<b>25 Pcs.</b>		
<b>13318PK</b>	#8 (4.20mm) Screw Size 16mm Stem Length 18mm Flange Diameter Natural Nylon Trim Screw Grommets Mercedes # 000-988-86-25	<b>25 Pcs.</b>		
<b>1572PK</b>	#8 (4.20mm) Screw Size 17mm Stem Length 16mm Head Diameter 8mm Hole Size Natural Nylon Screw Grommets Honda # 90661-SC7-0030, 90661-SC7-003 Mazda # H001-50-841, Mitsubishi # MS-480012 Nissan # 01651-00481, 74798-S90000, 01281-00231 Toyota # 90189-06042	<b>25 Pcs.</b>		
<b>11994PK</b>	#8 (4.20mm) Screw Size 18mm Stem Length 11.50mm Head Size Black Nylon Bumper & Tail Light Screw Grommets Ford # W708580-S300	<b>25 Pcs.</b>		

5



# Specialty Nuts

## Nuts Nylon















<b>10552PK</b>	#8 (4.20mm) Screw Size 18mm Stem Length 13.00 x 22.00mm Head Diameter 6.00 x 16.50mm Hole Size Natural Nylon With Sealer Back Glass Moulding & Inter. Trim Ford # W705590-S300, W710459-S300 G.M. # 25649667	<b>15 Pcs.</b>		
<b>10943PK</b>	#8 (4.20mm) Screw Size 18mm Stem Length 16mm Head Diameter 8mm Hole Size Black Nylon Interior Frame Grommets V.W. # 4A0-857-610	<b>25 Pcs.</b>		
<b>10406PK</b>	#8 (4.20mm) Screw Size 18mm Stem Length 16mm Head Diameter 9mm Hole Size Natural Nylon With Sealer Trunk Trim Screw Grommets Mitsubishi # MU480034	<b>15 Pcs.</b>		
<b>10938PK</b>	#8 (4.20mm) Screw Size 18.50mm Stem Length 16mm Head Diameter 8.50mm Hole Size Natural Nylon Screw Grommets V.W. # 321-813-998A	<b>25 Pcs.</b>		
<b>10524PK</b>	#8 (4.20mm) Screw Size 20mm Stem Length 15mm Head Size 8.50mm Hole Size Natural Nylon With Sealer Door Trim Screw Grommets Chrysler # 6507009-AA	<b>25 Pcs.</b>		
<b>10926PK</b>	#8 (4.20mm) Screw Size 20mm Stem Length 15mm Head Diameter 9mm Hole Size Black Nylon Bumper & Fender Screw Grommets V.W. # N908-214-01	<b>15 Pcs.</b>		
<b>12051PK</b>	#8 (4.20mm) Screw Size 20mm Stem Length 16mm Head Diameter Natural Nylon With Sealer Screw Grommets Nissan # 01281-00691	<b>15 Pcs.</b>		
<b>9662PK</b>	#8 (4.20mm) Screw Size 21mm Stem Length 18mm Head Size 8.50mm Hole Size Natural Nylon With Sealer Bumper Screw Grommets Hyundai # 86910-21010	<b>15 Pcs.</b>		
<b>2117PK</b>	#8 (4.20mm) Screw Size 23mm Stem Length 10mm Head Size 7mm Hole Size Natural Nylon Screw Grommets Ford # N804765-S	<b>50 Pcs.</b>		

# Specialty Nuts

## Retainers Grommets & Pin

<b>16447PK</b>	11/64" (4.50mm) Hole Size 5mm Stem Length 28mm Head Diameter Black Nylon Bumper Cover Grommets G.M. # 15265199	<b>25 Pcs.</b>		
----------------	-------------------------------------------------------------------------------------------------------------------------------	----------------	------------------------------------------------------------------------------------	-------------------------------------------------------------------------------------



















## Nuts Nylon

<b>9323PK</b>	#10 (4.80mm) Screw Size 7mm Stem Length 13mm Head Diameter 8mm Hole Size Natural Nylon Screw Grommets Mitsubishi # MB383455 Nissan # 01281-00022, 72774-01F00	<b>50 Pcs.</b>		
<b>1610PK</b>	#10 (4.80mm) Screw Size 7mm Stem Length 14mm Head Size 9mm Hole Size Black Nylon Screw Grommets Toyota # 90189-06018	<b>25 Pcs.</b>		
<b>13324PK</b>	#10 (4.80mm) Screw Size 7mm Stem Length 14.00 x 14.00mm Head Size 9.50 x 8.50mm Hole Size Yellow Nylon Screw Grommets Subaru # 66117-9000, 90930-0007	<b>25 Pcs.</b>		
<b>10978PK</b>	#10 (4.80mm) Screw Size 7.30mm Stem Length 17mm Head Size 1.50 x 7.00mm Hole Size Natural Nylon Bumper Grommets Honda # 90107-SX0-003	<b>15 Pcs.</b>		
<b>14992PK</b>	#10 (4.80mm) Screw Size 7.50mm Stem Length 11.50mm Head Size 8.00 x 8.00mm Hole Size Natural Nylon Spalsh Shield Grommets Mazda # 9991-00-501	<b>25 Pcs.</b>		
<b>15829PK</b>	#10 (4.80mm) Screw Size 8mm Stem Length 13mm Head Diameter 8mm Hole Size White Nylon License Plate Grommets G.M. # 3783006	<b>50 Pcs.</b>		
<b>1614PK</b>	#10 (4.80mm) Screw Size 8mm Stem Length 13mm Head Size 8.50mm Hole Size Natural Nylon Screw Grommets Honda # 75521-611-0000, 91619-SA5-003 Mazda # 9991-00-601 Nissan # 96706-P0105 Toyota # 90189-06010	<b>25 Pcs.</b>		

5

# Specialty Nuts

















## Nuts Nylon

<b>10771PK</b>	#10 (4.80mm) Screw Size 8mm Stem Length 14.70mm Head Diameter 8.50mm Hole Size Yellow Nylon Interior Trim Grommets Hyundai # 81385-38000	<b>25 Pcs.</b>		
<b>1296PK</b>	#10 (4.80mm) Screw Size 8mm Stem Length 16.50mm Head Size 8.00 x 8.50mm Hole Size Natural Nylon Screw Grommets Honda # 90662-671-0030, 90662-671-003, 90662-SB-003 Mazda # 9991-00-503 Nissan # 68425-H5000, 62698-V7000	<b>25 Pcs.</b>		
<b>15343PK</b>	#10 (4.80mm) Screw Size 8.70mm Stem Length 17.00 x 17.00mm Head Size White Nylon Arm Rest Screw Grommets Subaru # 94079AA000	<b>15 Pcs.</b>		
<b>10549PK</b>	#10 (4.80mm) Screw Size 9.50mm Stem Length 14.00 x 20.00mm Head Size White Nylon Cowl Vent Grommets Chrysler # 4860375-AB	<b>50 Pcs.</b>		
<b>10659PK</b>	#10 (4.80mm) Screw Size 10mm Stem Length 16mm Head Diameter 9mm Hole Size Natural Nylon Screw Grommets Nissan # 01281-00111 Toyota # 90189-06006	<b>25 Pcs.</b>		
<b>12914PK</b>	#10 (4.80mm) Screw Size 10mm Stem Length 16mm Head Size Black Nylon Wheel Well Moulding Screw Grommets Honda # 90107-S10-003	<b>25 Pcs.</b>		
<b>10796PK</b>	#10 (4.80mm) Screw Size 11mm Stem Length 12mm Head Size 9mm Hole Size White Nylon Bumper & Fender Screw Grommets Hyundai # 14913-05010	<b>25 Pcs.</b>		
<b>17945PK</b>	#10 (4.80mm) Screw Size 11mm Stem Length 9.50mm Head Size Natural Nylon Lower Door & Handle Interior Trim Grommets G.M. # 90230846, 94515248	<b>25 Pcs.</b>		
<b>1560PK</b>	#10 (4.80mm) Screw Size 11mm Stem Length 12mm Head Size 8.00 x 9.00mm Hole Size Natural Nylon Grille Screw Grommets G.M. # 94841764 Mitsubishi # MS480002, MS480009 Toyota # 90189-05013	<b>50 Pcs.</b>		

5





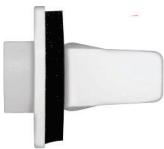





# Specialty Nuts

## Nuts Nylon

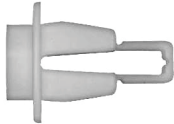

<b>17833PK</b>	#10 (4.80mm) Screw Size 11mm Stem Length 20mm Head Diameter 11.50 x 7.50mm Hole Size Black Nylon Radiator Grille Screw Grommets	<b>25 Pcs.</b>		
<b>17908PK</b>	#10 (4.80mm) Screw Size 11mm Stem Length 20mm Head Diameter 11.50 x 7.50mm Hole Size Red Nylon Radiator Grille Screw Grommets Ford # W702438-S300	<b>25 Pcs.</b>		
<b>10777PK</b>	#10 (4.80mm) Screw Size 12mm Stem Length 16mm Head Diameter 8.50mm Hole Size Black Nylon Fender Apron Screw Grommets Hyundai # 86848-22000, 86848-C8000	<b>25 Pcs.</b>		
<b>12585PK</b>	#10 (4.80mm) Screw Size 12.50mm Stem Length 12mm Head Diameter Black Nylon Screw Grommets Audi # 867-809-966 V.W. # 811-807-557-C	<b>25 Pcs.</b>		
<b>10620PK</b>	#10 (4.80mm) Screw Size 13mm Stem Length 16mm Head Diameter 8.50mm Hole Size Natural Nylon With Sealer Body Moulding Screw Grommets Nissan # 01281-00601	<b>15 Pcs.</b>		
<b>10981PK</b>	#10 (4.80mm) Screw Size 14mm Stem Length 14mm Head Size 8.50mm Hole Size Black Nylon Rear Bumper Screw Grommets Honda # 90682-SDA-A01	<b>15 Pcs.</b>		
<b>10426PK</b>	#10 (4.80mm) Screw Size 14mm Stem Length 25.00 x 26.00mm Head Size 9.50 x 23.00mm Hole Size Black Nylon Headlight To Grille Spacer Bracket Grommets Honda # 91635-SM4-003	<b>10 Pcs.</b>		
<b>13322PK</b>	#10 (4.80mm) Screw Size 15mm Stem Length 12mm Head Diameter 6.50 x 8.00mm Hole Size Black Nylon Screw Grommets V.W. # 6N0-809-966A	<b>25 Pcs.</b>		
<b>11156PK</b>	#10 (4.80mm) Screw Size 16mm Stem Length 20mm Flange Diameter 8.50mm Hole Size White Nylon With Sealer Bumper Grommets Nissan # 63846-5V000	<b>25 Pcs.</b>		

# Specialty Nuts



## Nuts Nylon

5	<b>15147PK</b>	#10 (4.80mm) Screw Size 17mm Stem Length 12.00 x 19.00mm Head Size 8.00 x 15.00mm Hole Size White Nylon Screw Grommets Honda # 90683-693-0000 Nissan # 78856-R4301	<b>25 Pcs.</b>		
	<b>1576PK</b>	#10 (4.80mm) Screw Size 17mm Stem Length 18mm Head Diameter 8.50mm Hole Size Natural Nylon Screw Grommets Mitsubishi # MB-098145 Nissan # 01281-00023, 01281-00231 Toyota # 90189-06001, 96706-U0100	<b>25 Pcs.</b>		
	<b>11036PK</b>	#10 (4.80mm) Screw Size 17.50mm Stem Length 16mm Head Diameter 10mm Hole Size Natural Nylon Front Bumper Grommets Nissan # 01281-01081	<b>15 Pcs.</b>		
	<b>12611PK</b>	#10 (4.80mm) Screw Size 18mm Stem Length 9.50 x 8.50mm Hole Size White Nylon With Sealer Bumper Cover Screw Nuts Hyundai # 86625-3S000	<b>25 Pcs.</b>		
	<b>10942PK</b>	#10 (4.80mm) Screw Size 20mm Stem Length 16mm Head Diameter 8mm Hole Size Black Nylon Door Panel Screw Grommets V.W. # 357-827-998	<b>15 Pcs.</b>		
	<b>11229PK</b>	#10 (4.80mm) Screw Size 24mm Stem Length 16mm Head Diameter 10mm Hole Size White Nylon With Sealer Front Bumper Screw Grommets Ford # W708319-S300	<b>25 Pcs.</b>		

## Retainers Grommets

















<b>10977PK</b>	5-.80mm Screw Size 8mm Stem Length 13mm Head Size 8mm Hole Size Natural Nylon Headlight Adjusting Grommets Honda # 90676-SA7-003, 90682-SB0-003	<b>25 Pcs.</b>		
----------------	-------------------------------------------------------------------------------------------------------------------------------------------------------------------	----------------	--------------------------------------------------------------------------------------	---------------------------------------------------------------------------------------

## Nuts Nylon

<b>10775PK</b>	#12 (5.50mm) Screw Size 8.50mm Stem Length 13mm Head Size 9mm Hole Size White Nylon Rocker Moulding Screw Grommets Hyundai # 87756-35000	<b>25 Pcs.</b>		
----------------	------------------------------------------------------------------------------------------------------------------------------------------------------------	----------------	--------------------------------------------------------------------------------------	---------------------------------------------------------------------------------------

# Specialty Nuts

## Nuts Nylon

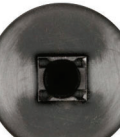
<b>18102PK</b>	#12 (5.50mm) Screw Size 9mm Stem Length 10mm Top Head Size Yellow Nylon Front & Rear Bumper Screw Grommets Nissan # 85099-1MA0A	<b>25 Pcs.</b>		
<b>10745PK</b>	#12 (5.50-6mm) Screw Size 9mm Stem Length 17.00 x 30.00mm Head Size Black Nylon Front Bumper Screw Grommets Toyota # 52535-50060, 52535-0E010	<b>5 Pcs.</b>		
<b>10794PK</b>	#12 (5.50mm) Screw Size 10mm Stem Length 14.00 x 16.00mm Head Size 9.00 x 11.00mm Hole Size White Nylon Front Bumper Screw Grommets Toyota # 90189-06193, 90189-06237	<b>25 Pcs.</b>		
<b>12073PK</b>	#12 (5.50mm) Screw Size 10mm Stem Length 17mm Head Diameter 9mm Square Hole Size Black Nylon Rocker & Floor Screw Grommets Toyota # 90189-06211	<b>25 Pcs.</b>		
<b>9503PK</b>	#12 (5.50mm) Screw Size 11mm Stem Length 15.60mm Flange Size 9mm Hole Size Black Nylon License Plate Nuts Chrysler # 6032516	<b>25 Pcs.</b>		
<b>10551PK</b>	#12 (5.50mm) Screw Size 9/16" Stem Length 5/8 x 3/4" Head Size 11/32 x 1/2" Hole Size Natural Nylon Door Handle Screw Grommets G.M. # 11517873	<b>15 Pcs.</b>		
<b>15839PK</b>	#12 (5.50mm) Screw Size 15mm Stem Length 16mm Head Diameter 10mm Hole Size Natural Nylon Back Panel Attachment Grommets Ford # W700566-S300	<b>25 Pcs.</b>		
<b>16470PK</b>	#12 (5.50mm) Screw Size 17mm Stem Length 18mm Head Diameter 9mm Hole Size Natural Nylon With Sealer Rear Door Screw Grommets Hyundai # 86910-22000 Toyota # 90189-06029, 90189-06084, 90189-06116	<b>10 Pcs.</b>		
<b>18164PK</b>	#12 (5.50mm) Screw Size 17mm Stem Length 20mm Flange Diameter 9mm Hole Size Black Nylon Fender Liner Screw Grommets Toyota # 90189-06236	<b>25 Pcs.</b>		

5

# Specialty Nuts















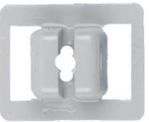



## Nuts Nylon

<b>15812PK</b>	#12 (5.50mm) Screw Size 17mm Stem Length 20mm Head Diameter 9mm Square Hole Size Black Nylon Screw Grommets Toyota # 90189-A0002	<b>25 Pcs.</b>		
<b>10988PK</b>	#12 (5.50mm) Screw Size 18mm Stem Length 16mm Head Diameter 9mm Hole Size Black Nylon Fender Liner Screw Grommets Toyota # 90189-06214	<b>15 Pcs.</b>		
<b>13323PK</b>	#12 (5.50mm) Screw Size 18mm Stem Length 20mm Head Diameter White Nylon With Sealer Screw Grommets Subaru # 91084AA010	<b>15 Pcs.</b>		
<b>11389PK</b>	#12 (5.50mm) Screw Size 18mm Stem Length 20mm Head Diameter 9mm Hole Size Black Nylon Fender & Hood Screw Grommets Toyota # 90189-06065	<b>15 Pcs.</b>		
<b>9912PK</b>	#12 (5.50mm) Screw Size 19mm Stem Length 16mm Head Diameter 8mm Square Hole Size Black Nylon Front & Rear Wheel Fender Liner Screw Grommets G.M # 94854203 Toyota # 90189-06028	<b>15 Pcs.</b>		
<b>9136PK</b>	#12 (5.50mm) Screw Size 13/16" Stem Length 1/2" Head Size 3/8" Square Hole Natural Nylon Windshield Washer Reservoir Mounting Screw Grommets Ford # F5RZ-17K657-A	<b>25 Pcs.</b>		
<b>9913PK</b>	#12 (5.50mm) Screw Size 22mm Stem Length 20mm Head Diameter 8mm Square Hole Size Black Nylon Front & Rear Wheel Fender Liner Screw Grommets Toyota # 90189-06157	<b>15 Pcs.</b>		
<b>9481PK</b>	#12 (5.50mm) Screw Size 24mm Stem Length 22.00 x 18.00mm Head Size White Nylon With Sealer Front Bumper Screw Grommets Lexus # 52197-30040	<b>15 Pcs.</b>		

5



# Specialty Nuts

## Nuts Nylon

<b>18831PK</b>	6-1.00mm Thread Size 25/64" (10mm) Hole Size 18mm Flange Diameter 10mm Height Black Nylon Wheel Apron Thumb Drive Nuts Toyota # 90467-06169	<b>25 Pcs.</b>			<b>NEW</b>
<b>9101PK</b>	#14 (6.30mm) Screw Size 8mm Stem Length 13.00 x 15.00mm Head Size 8.50 x 10.50mm Hole Size Natural Nylon Screw Grommets Honda # 90656-671-6310M1	<b>50 Pcs.</b>			
<b>9494PK</b>	#14 (6.30mm) Screw Size 5/16" Stem Length 5/8 x 3/4" Head Size 3/8" Hole Size Natural Nylon License Plate Nuts Ford # 380707-S	<b>50 Pcs.</b>			
<b>9872PK</b>	#14 (6.30mm) Screw Size 8mm Stem Length 14.30mm Head Diameter 8.50mm Hole Size Natural Nylon License Plate Screw Grommets G.M. # 380370	<b>50 Pcs.</b>			
<b>17927PK</b>	#14 (6.30mm) Screw Size 8mm Stem Length 16mm Head Size Black Nylon With Sealer Bumper, License Plate & Tail Light Screw Grommets G.M. # 25832258	<b>10 Pcs.</b>			
<b>1228PK</b>	#14 (6.30mm) Screw Size 5/16" Stem Length 5/8" Head Size 13/32" Hole Size White Plastic License Plate Nuts Chrysler # 6023925 G.M. # 3907444	<b>50 Pcs.</b>			
<b>10461PK</b>	#14 (6.30mm) Screw Size 8mm Stem Length 16mm Head Size 9.50 x 10.00mm Hole Size Black Nylon With Sealer License Plate Grommets Ford # N811478-S100	<b>15 Pcs.</b>			
<b>9678PK</b>	#14 (6.30mm) Screw Size 10mm Stem Length 12.00 x 16.00mm Head Size Gray Nylon Wheel Well Opening Screw Grommets Use With # 9679 Nissan # 76848-JG00A	<b>15 Pcs.</b>			
<b>9679PK</b>	8 x 17mm Head Size 12mm Stem Length Yellow Nylon Wheel Well Opening Moulding Clips Use With # 9678 Nissan # 76847-JG00A	<b>25 Pcs.</b>			



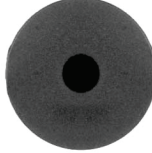











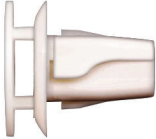

# Specialty Nuts

## Nuts Nylon

<b>12664PK</b>	#14 (6.30mm) Screw Size 11mm Stem Length 15mm Head Diameter 9.50mm Hole Size Natural Nylon Screw Grommets G.M. # 4755299	<b>50 Pcs.</b>		
<b>10525PK</b>	#14 (6.30mm) Screw Size 14mm Stem Length 20mm Head Size 8mm Hole Size Black Nylon License Plate Grommets G.M. # 22546934	<b>50 Pcs.</b>		
<b>11020PK</b>	#14 (6.30mm) Screw Size 16mm Stem Length 20mm Head Diameter 10mm Hole Size Natural Nylon With Sealer Rocker Panel Screw Grommets Nissan # 01281-00331	<b>25 Pcs.</b>		
<b>1605PK</b>	#14 (6.30mm) Screw Size 17mm Stem Length 20mm Head Diameter 8mm Square Hole Size Black Nylon Screw Grommets Toyota # 90189-06013, 96706-W100	<b>25 Pcs.</b>		
<b>10550PK</b>	#14 (6.30mm) Screw Size 17mm Stem Length 24mm Head Size 15mm Hole Size Black Nylon With Sealer Light Housing Screw Grommets G.M. # 15745990, 15289020, 11609535	<b>15 Pcs.</b>		
<b>13437PK</b>	#14 (6.30mm) Screw Size 19mm Stem Length 16.00 x 18.00mm Head Size Black Nylon Bumper Side Bracket Screw Grommets Toyota # 52197-22020	<b>15 Pcs.</b>		
<b>10119PK</b>	#14 (6.30mm) Screw Size 3/8" Hole Size Natural Nylon License Plate Screw Grommets Chrysler # 6027958	<b>10 Pcs.</b>		
<b>11391PK</b>	#14 (6.30mm) Screw Size 23mm Stem Length 15.00 x 18.00mm Head Size White Nylon With Sealer Rear Bumper Screw Grommets G.M. # 25704358	<b>10 Pcs.</b>		
<b>1608PK</b>	#14 (6.30-1.81mm) Screw Size 16mm Stem Length 18mm Head Diameter 8mm Hole Size White Nylon Screw Grommets Toyota # 90189-06005	<b>50 Pcs.</b>		

# Specialty Nuts



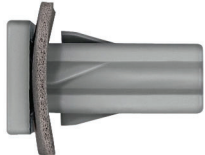













## Nuts Nylon

<b>15330PK</b>	8mm Square Hole Size 10mm Stem Length 11.00 x 11.00mm Head Size Blue Nylon Screw Grommets Subaru # 62731-FA010	<b>25 Pcs.</b>		
<b>13440PK</b>	#14 (6.30-1.81mm) Screw Size 16mm Stem Length 15.00 x 19.00mm Head Size Brown Nylon With Sealer Screw Grommets Nissan # 26557-2U001	<b>15 Pcs.</b>		
<b>17067PK</b>	5/16" (8mm) Hole Size 14mm Stem Length 18mm Head Diameter Natural Nylon With Sealer Tail Light Grommets Mazda # GA7B-51-146	<b>25 Pcs.</b>		
<b>9079PK</b>	23/64" (9mm) Hole Size 15mm Stem Length 18mm Head Diameter White Nylon Front Fender Screw Grommets Toyota # 90189-06114	<b>15 Pcs.</b>		
<b>17086PK</b>	23/64" (9mm) Square Hole Size 17mm Stem Length 18mm Flange Size Yellow Nylon Bumper Cover W/Sealer Screw Grommets Toyota # 52188-33040	<b>25 Pcs.</b>		
<b>16444PK</b>	3/8" (9.40mm) Square Hole Size 12.50mm Stem Length 22mm Head Diameter Natural Nylon Front & Rear Door Panel Screw Grommets Ford # W711501-S300	<b>25 Pcs.</b>		
<b>15341PK</b>	25/64" (10mm) Hole Size 19.50mm Stem Length 25.00 x 33.00mm Head Size Black Nylon With Sealer Bumper Cover Grommets Subaru # 99011FC000NN	<b>15 Pcs.</b>		
<b>10055PK</b>	15/32" (12mm) Hole Size 12mm Stem Length 16mm Head Size Black Nylon Tail Light Grommets Chrysler # 6504072	<b>25 Pcs.</b>		
<b>16308PK</b>	15/64" (6.00mm) Screw Size 23mm Stem Length 15mm Square Head 10mm Square Hole Size Gray Nylon With Sealer License Plate Grommets Ford # W714172-S300	<b>15 Pcs.</b>		

5

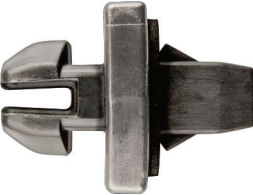
# Specialty Nuts



















## Nuts Nylon

<b>13248PK</b>	33/64" (13mm) Hole Size 21mm Stem Length 24mm Head Diameter Black Nylon Bumper Cover Grommet Mitsubishi # MB271999	<b>10 Pcs.</b>		
<b>13299PK</b>	5mm Stud Diameter 10mm Hex Size 16mm Flange Diameter Black Nylon Flange Nuts BMW # 16-13-1-176-747 Mercedes # 003-990-02-51	<b>25 Pcs.</b>		
<b>12062PK</b>	11mm Head Size 9mm Stem Length 8mm Hole Size White Nylon Front & Rear Bumper Cover Grommets Kia # 86699-2D000	<b>25 Pcs.</b>		
<b>13083PK</b>	16mm Head Diameter 12mm Stem Length 8mm Hole Size Black Nylon Screw Grommets Nissan # 76881-JG00A	<b>15 Pcs.</b>		
<b>11397PK</b>	18mm Top Head Diameter 9.50mm Stem Length 10mm Hole Size Natural Nylon Bumper Grommets Honda # 91509-SM4-000	<b>10 Pcs.</b>		
<b>10999PK</b>	18.00 x 20.00mm Head Size 19mm Stem Length 8.00 x 11.00mm Hole Size White Nylon Bumper Grommets Honda # 90106-SW3-003	<b>10 Pcs.</b>		
<b>12075PK</b>	25 x 30mm Head Size 15mm Stem Length 35mm Overall Length Black Nylon With Sealer Bumper Cover Grommet Kia # 86591-25000	<b>5 Pcs.</b>		
<b>10971PK</b>	17mm Overall Height 30mm Overall Length Black Nylon Bumper Filler Clips Toyota # 53935-35020	<b>10 Pcs.</b>		
<b>11129PK</b>	22mm Overall Length Natural Nylon Front Bumper Grommets Nissan # 01281-01321	<b>50 Pcs.</b>		

5

# Specialty Nuts



## Retainers Grommets

<b>15716PK</b>	9/32" (7mm) Hole Size 5mm Stem Length 9mm Head Diameter White Nylon Moulding Grommet Mercedes # 000-987-10-81	<b>50 Pcs.</b>		
<b>13333PK</b>	9/32" (7mm) Stud Size 16mm Stem Length 16mm Head Diameter 8.50mm Hole Size Natural Nylon Tubular Nuts BMW # 51-44-7-780-135 Mercedes # 108-988-00-27	<b>25 Pcs.</b>		
<b>16456PK</b>	5/16" (8mm) Hole Size 13mm Stem Length 13mm Head Diameter White Nylon With Sealer Cowl & Wheelhouse Screw Grommets Honda # 90601-S30-003			
<b>16455PK</b>	5/16" (8mm) Hole Size 14mm Stem Length 18mm Head Diameter Blue Nylon With Sealer Tail Light Grommets Honda # 91626-TA0-A01	<b>25 Pcs.</b>		
<b>18884PK</b>	21/64" (8.50mm) Hole Size 14mm Stem Length 15mm x 19mm Head Size White Nylon Tail Light Grommets Subaru # 909220013	<b>15 Pcs.</b>		 <b>NEW!</b>
<b>10498PK</b>	8.75 x 15.75mm Hole Size 17.50mm Stem Length 13.00 x 20.00mm Head Size Blue Nylon With Sealer Headlight Screw Grommets G.M. # 11561382, 11610198	<b>10 Pcs.</b>		
<b>10973PK</b>	23/64" (9mm) Hole Size 6mm Stem Length 13mm Head Diameter Black Nylon Inserts Grommets V.W. # 357-853-586D	<b>25 Pcs.</b>		
<b>1404PK</b>	23/64" (9mm) Hole Size 6.70mm Stem Length 10.50mm Head Diameter 4.50mm Pin Diameter Red Nylon Moulding Grommets Mercedes # 000-988-15-81	<b>50 Pcs.</b>		
<b>12477PK</b>	23/64" (9mm) Hole Size 12mm Stem Length 11.50mm Head Diameter White Nylon Moulding Insert Grommets Mercedes # 001-988-20-81, 001-988-76-81	<b>25 Pcs.</b>		



5

# Specialty Nuts



## Nuts Nylon

<b>12626PK</b>	23/64" (9mm) Hole Size 14mm Stem Length 4.50mm Inside Diameter Red Nylon Tubular Nuts Mercedes # 001-988-20-81	<b>50 Pcs.</b>		
----------------	-------------------------------------------------------------------------------------------------------------------------------	----------------	------------------------------------------------------------------------------------	-------------------------------------------------------------------------------------



## Nuts Miscellaneous

<b>18099PK</b>	23/64" (9mm) Hole Size 9mm Overall Height 30mm Head Diameter Gray Nylon Sound Insulation Grommets BMW # 51-48-8-126-849	<b>25 Pcs.</b>		
----------------	----------------------------------------------------------------------------------------------------------------------------------------	----------------	------------------------------------------------------------------------------------	-------------------------------------------------------------------------------------



## 5 Retainers Grommets



<b>18261PK</b>	9.80mm Hole Size 4.80mm Stud Size 17mm Head Diameter Black Rubber Tail Lamp Grommet G.M. # 11571225	<b>10 Pcs.</b>		
----------------	--------------------------------------------------------------------------------------------------------------------	----------------	------------------------------------------------------------------------------------	-------------------------------------------------------------------------------------



## Nuts Push On Type Non-Threaded Stud



<b>16450PK</b>	5mm Stud 25/64" (10mm) Hole Size 8mm Stem Length 30mm Head Diameter Black Nylon Wheel House Liner Retainers G.M. # 94530387	<b>25 Pcs.</b>		
----------------	-----------------------------------------------------------------------------------------------------------------------------------------------	----------------	-------------------------------------------------------------------------------------	--------------------------------------------------------------------------------------

## Retainers Grommets

<b>12024PK</b>	10.00 x 11.00mm Hole Size 10mm Stem Length 13.00 x 17.00mm Head Size Black Nylon Tail Light Grommets Ford # W711079-S300	<b>25 Pcs.</b>		
----------------	-----------------------------------------------------------------------------------------------------------------------------------------	----------------	--------------------------------------------------------------------------------------	---------------------------------------------------------------------------------------





<b>9355PK</b>	25/64" (10mm) Hole Size 9mm Stem Length 13mm Head Diameter Black Nylon Grille & Side Marker Light Screw Grommets Ford # N807994-S, N811169S, W704740-S300, W705550S300	<b>50 Pcs.</b>		
---------------	------------------------------------------------------------------------------------------------------------------------------------------------------------------------------------------	----------------	--------------------------------------------------------------------------------------	---------------------------------------------------------------------------------------

<b>10781PK</b>	25/64" (10mm) Hole Size 8mm Stem Length 15mm Head Diameter Natural Nylon Headlight Assembly Grommets Hyundai # XG300/350 Kia # 92351-37000	<b>25 Pcs.</b>		
----------------	--------------------------------------------------------------------------------------------------------------------------------------------------------------	----------------	--------------------------------------------------------------------------------------	---------------------------------------------------------------------------------------

<b>15816PK</b>	25/64" (10mm) Hole Size 15mm Stem Length 18mm Head Diameter White Nylon With Sealer Tail Light Grommets G.M. # 22884291	<b>10 Pcs.</b>		
----------------	----------------------------------------------------------------------------------------------------------------------------------------	----------------	--------------------------------------------------------------------------------------	---------------------------------------------------------------------------------------

# Specialty Nuts



## Retainers Grommets



<b>16374PK</b>	7/16" (11mm) Hole Size 14mm Stem Length 16mm Flange Diameter Natural Nylon With Sealer Screw Grommets Honda # 90601-SNV-P01	<b>25 Pcs.</b>		
<b>16309PK</b>	25/64" (10mm) Hole Size 17.50mm Overall Length 19mm Head Diameter Orange Nylon With Sealer Tail Lamp Grommets G.M. # 84221533	<b>10 Pcs.</b>		
<b>13368PK</b>	7/16" (11mm) Hole Size 16mm Stem Length 16mm Head Diameter White Nylon Fog Light Grommets G.M. # 11570830	<b>15 Pcs.</b>		
<b>9712PK</b>	7/16" (11mm) Hole Size 9mm Stem Length 13mm Head Diameter White Nylon Park & Turn Signal Grommets Ford # N811169-S, W705550-S300 G.M. # 10423331 Toyota # 90075-10801, 90189-06111	<b>50 Pcs.</b>		
<b>10526PK</b>	7/16" (11mm) Hole Size 17mm Stem Length 15mm Head Diameter Black Nylon With Sealer Tail Light Grommets G.M. # 11561655, 11609862, 11610705	<b>5 Pcs.</b>		
<b>9418PK</b>	11.50 x 15.50mm Hole Size 26mm Length 22mm Width Black Nylon Grille Grommet Retainers Nissan # 62380-U7400	<b>10 Pcs.</b>		
<b>15017PK</b>	11.50 x 18.00mm Hole Size 10mm Stem Length 17.00 x 23.00mm Head Size Black Nylon Headlight Assembly Grommets Nissan # 76848-8J010	<b>10 Pcs.</b>		
<b>11127PK</b>	12mm Hole Size 11mm Stem Length 19mm Head Diameter Black Nylon Tail Light Assembly Grommets Chrysler # 68084593-AA	<b>25 Pcs.</b>		
<b>10541PK</b>	14.00 x 26.00mm Hole Size 20.00 x 31.00mm Head Size Receives 10mm Ball Stud Black Nylon Tail Light Grommets Chrysler # 55156879-AB	<b>25 Pcs.</b>		

5

# Specialty Nuts

## Retainers Grommets



<b>11162PK</b>	19/32" (15mm) Hole Size 21mm Stem Length 24mm Head Diameter .90mm Thick Panel Black Nylon With Sealer Tail Light Grommets G.M. # 11561987	<b>15 Pcs.</b>		
----------------	-------------------------------------------------------------------------------------------------------------------------------------------------------------	----------------	------------------------------------------------------------------------------------	-------------------------------------------------------------------------------------

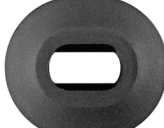
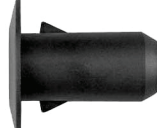

<b>10554PK</b>	9.00 x 16.00mm Hole Size 17mm Stem Length 13.00 x 20.00mm Head Size Black Nylon Rear Light Housing Screw Grommets Chrysler # 5113360-AA G.M. # 15284612, 11609536, 15745991	<b>15 Pcs.</b>		
----------------	--------------------------------------------------------------------------------------------------------------------------------------------------------------------------------------------------	----------------	------------------------------------------------------------------------------------	-------------------------------------------------------------------------------------



5



<b>11126PK</b>	9.50 x 21.50mm Hole Size 18mm Stem Length 18.50 x 21.50mm Head Size Black Nylon Headlight & Tail Light Grommets Ford # F50Y-14603-A	<b>25 Pcs.</b>		
----------------	----------------------------------------------------------------------------------------------------------------------------------------------------	----------------	------------------------------------------------------------------------------------	-------------------------------------------------------------------------------------



## Retainers Grommets & Pin

<b>12093PK</b>	9/32" (7mm) Hole Size 7mm Stem Length 14mm Flange Diameter 3mm Pin Diameter Natural Nylon Cowl Grommets Use With #12094 Subaru # 91486-KJ000	<b>25 Pcs.</b>		
----------------	-------------------------------------------------------------------------------------------------------------------------------------------------------------------	----------------	------------------------------------------------------------------------------------	-------------------------------------------------------------------------------------

<b>16387PK</b>	9/32" (7mm) Hole Size 7.30mm Stem Length 16mm Head Diameter Gray Nylon Cowl Grille Grommets Use With Disco # 12094 Subaru # 91486FL020	<b>25 Pcs.</b>		
----------------	----------------------------------------------------------------------------------------------------------------------------------------------------------	----------------	--------------------------------------------------------------------------------------	---------------------------------------------------------------------------------------

<b>12094PK</b>	3mm Pin Diameter 13mm Stem Length 16.00 x 18.00mm Head Size Black Nylon Cowl Retainers Use With #12093 or 16387 Subaru # 91486-KJ010	<b>25 Pcs.</b>		
----------------	--------------------------------------------------------------------------------------------------------------------------------------------------------	----------------	--------------------------------------------------------------------------------------	---------------------------------------------------------------------------------------

<b>10959PK</b>	5/16" (8mm) Hole Size 11mm Stem Length 13.20mm Head Diameter 6mm Pin Diameter Natural Nylon Door Trim Panel Grommets Use With #10958 V.W. # 3B0-867-334	<b>50 Pcs.</b>		
----------------	------------------------------------------------------------------------------------------------------------------------------------------------------------------------------	----------------	--------------------------------------------------------------------------------------	---------------------------------------------------------------------------------------

<b>10958PK</b>	6mm Pin Diameter 12.50mm Top Head Diameter 16mm Stem Length Natural Nylon Door Trim Panel Retainers Use With #10959 V.W. # 3B0-867-333	<b>25 Pcs.</b>		
----------------	----------------------------------------------------------------------------------------------------------------------------------------------------------	----------------	--------------------------------------------------------------------------------------	---------------------------------------------------------------------------------------

# Specialty Nuts

## Retainers Nylon Grommets & Pin

<b>12376PK</b>	23/64" (9mm) Hole Size 16mm Stem Length 18mm Head Diameter White Nylon Cowl Vent Grommets Use With # 12375 Toyota # 90467-10152	<b>10 Pcs.</b>		
<b>12375PK</b>	23/64" (9mm) Pin Size 17mm Stem Length 16mm Head Diameter Black Nylon Cowl Vent Pin Retainers Use With # 12376 Toyota # 90467-07126	<b>10 Pcs.</b>		
<b>10467PK</b>	23/64" (9mm) Hole Size 12mm Stem Length 19mm Head Diameter 3mm Pin Diameter White Nylon Door Panel Grommets Use With #10466 Chrysler # 6506655AA	<b>25 Pcs.</b>		
<b>11169PK</b>	23/64" (9mm) Hole Size 12mm Stem Length 19mm Head Diameter 3mm Pin Diameter Green Nylon Door Panel Grommets Use With #10466 Chrysler # 4784018-AA	<b>25 Pcs.</b>		
<b>10466PK</b>	3mm Pin Diameter 20mm Stem Length 13mm Top Head Diameter White Nylon Door Trim Panel Pin Retainers Use With #10467 & #11169	<b>25 Pcs.</b>		
<b>18145PK</b>	3/8" (9.50mm) Hole Size 21mm Stem Length Natural Rubber Rear Bumper Cover Grommets Use With # 17832	<b>25 Pcs.</b>		
<b>18255PK</b>	3/8" (9.50mm) Hole Size 21mm Stem Length Black Rubber Rear Bumper Cover Grommets Use With # 17832 Ford # W708045-S300	<b>25 Pcs.</b>		
<b>17832PK</b>	9/32" (7mm) Hole Size 25mm Stem Length 21mm Head Diameter Black Nylon Rear Bumper Cover Retainers Use With # 18145 & 18255 Ford # W708035-S300	<b>25 Pcs.</b>		
<b>10618PK</b>	8.00 x 9.00mm Hole Size 13mm Stem Length 13mm Head Size 4.10mm Pin Diameter White Nylon With Sealer Cowl Vent Screw Grommets Use With #10678 Nissan # 80874-0P00	<b>15 Pcs.</b>		

5

# Specialty Nuts

## Retainers Nylon Grommets & Pin

<b>10678PK</b>	4.10mm Pin Diameter 15mm Stem Length 10mm Head Diameter Black Nylon Cowl Screen Pin Retainers Use With #10618 Nissan # 66820-88E00	<b>25 Pcs.</b>		
<b>13255PK</b>	6mm Stud Size 20mm Overall Width 16mm Overall Height Black Nylon Skid Shield Grommets Use With # 12589 V.W. # 4A0805163	<b>25 Pcs.</b>		
<b>12589PK</b>	6mm Stud Size 22mm Stem Length 25mm Head Diameter Black Nylon Skid Plate Screws Use With # 13255 V.W. # 4A0-805-121A	<b>25 Pcs.</b>		
<b>11189PK</b>	9.50 x 13.50mm Hole Size 18mm Stem Length 17.50 x 21.50mm Head Size 5mm Pin Diameter Black Nylon Fascia Grommets Use With #11190 G.M. # 22603044	<b>15 Pcs.</b>		
<b>11190PK</b>	5mm Pin Diameter 19.70mm Pin Length 3.30mm Panel Range Black Nylon Front Bumper Fascia Hinged Pin Retainers Use With #11189 G.M. 22615352, 11588782, 22603043	<b>15 Pcs.</b>		
<b>11984PK</b>	5.80mm Stud Size 13mm Hex Size 25mm Washer Diameter Black Nylon Grille Retainer Nuts Use With # 11983 Camaro 2010 Cadillac SRS & SRX G.M. # 11610748	<b>25 Pcs.</b>		
<b>11983PK</b>	5.80mm Stem Diameter 25.50mm Stem Length 25mm Head Diameter Black Nylon Slotted Grille Retainers Use With # 11984 Camaro 2010 Cadillac SRS & SRX G.M. # 11610747	<b>25 Pcs.</b>		
<b>16446PK</b>	28mm Top Diameter 17.50mm Bottom Diameter 23mm Overall Height Black Nylon Body Mount Cushion Sleeves G.M. # 15924986	<b>25 Pcs.</b>		

5

# Specialty Nuts

## Retainers Nylon Grommets & Pin

### 18230PK

13.50 x 7.60mm Hole Size  
16mm Stem Length  
14.00 x 22.00mm Head Size  
Dark Gray  
Engine Cover Grommets  
Honda # 91548-T25-A02

25 Pcs.



### 18229PK

17mm Stem Length  
22mm Overall Length  
13mm Top Head Diameter  
Black Nylon  
Engine Cover Retainers  
Honda # 91547-T25-A02

50 Pcs.



## Nuts Metal Miscellaneous

### 12273PK

#6 (3.50mm) Screw Size  
10mm Width  
18mm Overall Height  
Zinc Finish  
Bumper & Grille Fasteners  
Chrysler # 4806226-AA, 68004187-AA  
Ford # W710754-S439  
G.M. # 11562364

15 Pcs.



### 9199PK

#8 (4.20mm) Screw Size  
Zinc Finish  
Radiator Grille Nuts  
Ford # N802865-S100  
G.M. # 15686142, 11561448

25 Pcs.



### 11258PK

#8 (4.20mm) Screw Size  
8.65mm Hole Size  
Zinc Finish  
Fender Bracket Push In Nuts  
G.M. # 11518531, 11609952

15 Pcs.



### 12983PK

#8 (4.20mm) Screw Size  
6.00 x 16.00mm Head Size  
7mm Overall Height  
Silver Finish  
Front Bumper Nuts  
G.M. # 11609952

25 Pcs.



### 11032PK

#8 (4.20mm) Screw Size  
.70 - 2.30mm Panel Range  
8.70mm Hole Size  
Blue Finish  
Mid Panel Nuts  
Chrysler # 6509432AA  
Ford # W716529-S900  
G.M. # 1570654

25 Pcs.



### 10733PK

#8 (4.20mm) Screw Size  
.70 - 1.50mm Panel Range  
8.70mm Hole Size  
Gray Finish With Sealer  
Tail Light Quarter Panel Nuts  
Ford # W714171-S439  
G.M. # 11569711

25 Pcs.



### 18096PK





















#8 (4.20mm) Screw Size  
11.70mm Width  
16.50mm Length  
Gray Finish With Sealer  
Specialty Nuts  
Ford # W713617-S439

15 Pcs.



# Specialty Nuts

## Nuts Metal Miscellaneous

<b>11034PK</b>	#8 (4.20mm) Screw Size 9.00 x 11.00mm Hole Size Black Finish Dash Panel Nuts Ford # N803685S G.M. # 14083173, 17997722, 17988488	<b>25 Pcs.</b>		
<b>17071PK</b>	#8 (4.20mm) Screw Size 10.50 x 12mm Head Size 11mm Stem Length Zinc Finish Radiator Grille Panel Nuts Chrysler # 6510197AA	<b>25 Pcs.</b>		
<b>15983PK</b>	#8 (4.80mm) Screw Size 7mm Stem Length 14 x 23mm Head Size Zinc Organic Front & Rear Bumper Specialty Nuts With Patisol Pad Ford # W715197-S439	<b>10 Pcs.</b>		
<b>15864PK</b>	#8 (4.20-1.41mm) Screw Size 1.40 - 5mm Panel Range 10.90 x 13.00mm Hole Size Green Metallic Finish Bracket Retainer Nuts G.M. # 11548673	<b>15 Pcs.</b>		
<b>15691PK</b>	#8 (4.20-1.41mm) Screw Size Zinc Organic Center Console Door, Front Lights, Grille, Lift Gate Nuts With Silicone Pad G.M. # 11610157	<b>10 Pcs.</b>		
<b>16065PK</b>	#8 (4.20mm) Screw Size .50 - 1.00mm Panel Range 8.55mm Square Hole Size Green Finish W/Silicone Pad Door Panel & Bumper Nuts G.M. # 11546868	<b>15 Pcs.</b>		
<b>10143PK</b>	17/32" (13.50mm) Hole Size 11mm Overall Length Zinc Finish Headlamp Assembly Nuts G.M. # 11570015	<b>15 Pcs.</b>		
<b>16314PK</b>	6-1.00 Screw Size 9/16" (14mm) Square Hole 16.25mm Overall Length Black Finish Bumper, Door Glass & Grille Nuts Chrysler # 6505223AA	<b>10 Pcs.</b>		
<b>18265PK</b>	6-1.00mm Screw Size 10mm Stem length 15mm Square Hole Size 14.50 x 21.00mm Head Size Magni-554 Finish Door & Fender Nuts Chrysler # 6506955AA	<b>10 Pcs.</b>		
<b>18094PK</b>	6-1.00 Screw Size .70-3.80mm Panel Range 9.25 x 13.75mm Hole Size Zinc Finish Rear Bumper Bracket Nuts G.M. # 11547582	<b>25 Pcs.</b>		

# Specialty Nuts

## Nuts Metal Miscellaneous

### 13423PK

6-1.00 Screw Size  
11mm Overall Height  
Zinc Organic  
Radiators Grille & Front  
End Panel Nuts  
G.M. # 11518937

10 Pcs.



### 15902PK

6-1.00mm Screw Size  
12mm Overall Height  
Organic Zinc Finish  
Front Fender Panel Nuts  
G.M. # 11610544

10 Pcs.



### 9597PK

6-1.00mm Screw Size  
Zinc Organic  
License Plate Nuts  
G.M. # 15707256

10 Pcs.

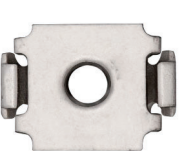

### 12849PK

6-1.00mm Thread Size  
Black Nylon  
Metal Insert Threaded  
Hood Adjustment Nuts  
Ford 1989 - On

10 Pcs.



### 9709PK

5/16"-18 Thread Size  
Plain Finish  
Slab Weld Nuts

25 Pcs.



## Nuts Hex Type Automotive

### 12439PK

5-.80mm Thread Size  
10mm Hex Size  
10mm Flange Diameter  
.70 - 1.50mm Grip Range  
Silver and Wax Finish  
Hex Type Steel Nutserts  
Chrysler # 6503812\_6504601

15 Pcs.



### 12444PK

6-1.00mm Thread Size  
8mm Hex Size  
12mm Flange Diameter  
.65 - 2mm Grip Range  
Zinc Finish W/Sealer  
Hex Type Steel Nutserts  
Ford # N803763-S100  
G.M. # 15685099\_11518684

15 Pcs.



### 12443PK

6-1.00mm Thread Size  
9.50mm Hex Size  
13mm Flange Diameter  
.50 - 4.20mm Grip Range  
Yellow Zinc W/Sealer  
Hex Type Steel Nutserts  
Ford # W706172-S309\_ W708384-S309

15 Pcs.



### 12440PK









6-1.00mm Thread Size  
9.50mm Hex Size  
13mm Flange Diameter  
.70 - 4mm Grip Range  
Front Core Support  
Zinc Hex Type Steel Nutserts  
G.M. # 11519952

15 Pcs.



# Specialty Nuts

## Nutserts Hex Type Automotive

<b>12445PK</b>	6-1.00mm Thread Size 9.50mm Hex Size 17mm Flange Diameter .70 - 3.20mm Grip Range Zinc Finish Hex Type Steel Nutserts Chrysler # 6506104AA	<b>10 Pcs.</b>		
<b>12446PK</b>	6-1.00mm Thread Size 9.50mm Hex Size 17mm Flange Diameter .70 - 3.17mm Grip Range Zinc Finish Hex Type Steel Nutserts Chrysler # 6509106-AA	<b>15 Pcs.</b>		
<b>12441PK</b>	8-1.25mm Thread Size 12.50mm Hex Size 17mm Flange Diameter .70 - 4mm Grip Range Zinc Finish Hex Type Steel Nutserts G.M. # 11519960	<b>15 Pcs.</b>		
<b>11406PK</b>	8-1.25mm Thread Size 12.70mm Hex Size 22mm Flange Diameter .70 - 3.80mm Grip Range Zinc Finish Hex Type Steel Nutserts Ford # W708513-S437	<b>15 Pcs.</b>		

## Nutserts Thin Sheet

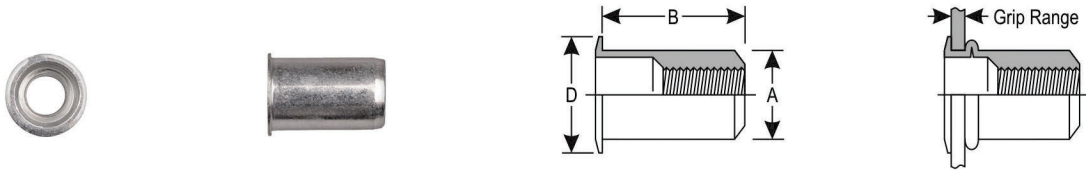

Part #	Thread Size	Grip Range	A	B	D	Drill Size	Qty.
<b>13130PK</b>	6-32	.020 - .080"	.249"	.385"	.295"	1/4"	50 Pcs.
<b>13131PK</b>	8-32	.020 - .080"	.249"	.385"	.295"	1/4"	50 Pcs.
<b>13132PK</b>	10-24	.020 - .130"	.280"	.440"	.320"	9/32"	50 Pcs.
<b>13133PK</b>	10-32	.020 - .130"	.280"	.440"	.320"	9/32"	50 Pcs.
<b>13134PK</b>	1/4-20	.030 - .165"	.347"	.580"	.425"	3/8"	25 Pcs.
<b>13136PK</b>	5/16-18	.030 - .165"	.499"	.690"	.560"	1/2"	25 Pcs.
<b>13138PK</b>	3/8-16	.040 - .200"	.499"	.690"	.560"	1/2"	15 Pcs.
<b>13140PK</b>	4-.70mm	.50 - 2.00mm	6.32mm	9.78mm	7.49mm	6.40mm	50 Pcs.
<b>13141PK</b>	5-.80mm	.50 - 3.30mm	7.11mm	11.18mm	8.13mm	7.20mm	50 Pcs.
<b>13142PK</b>	6-1.00mm	.75 - 4.20mm	9.50mm	14.73mm	10.80mm	9.60mm	25 Pcs.
<b>13143PK</b>	8-1.25mm	1.02 - 5.10mm	12.67mm	17.53mm	14.22mm	12.70mm	25 Pcs.
<b>13144PK</b>	10-1.50mm	1.02-5.10mm	12.67mm	17.53mm	14.22mm	12.70mm	15 Pcs.

# Specialty Nuts

## Nutserts Round Type

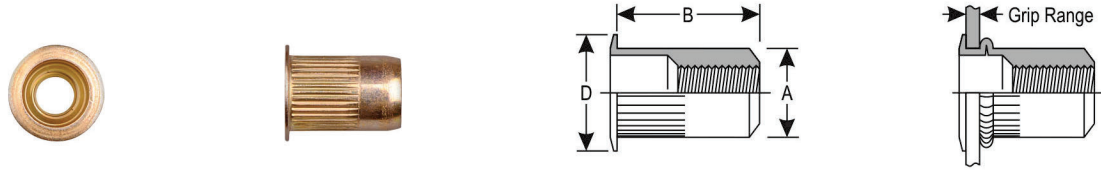

Part #	Thread Size	Grip Range	A	B	D	Drill Size	Qty.
12694PK	6-32	.020-.080"	.265"	.420"	.390"	17/64"	25 Pcs.
12696PK	8-32	.020-.080"	.265"	.420"	.390"	17/64"	25 Pcs.
12698PK	10-24	.020-.130"	.296"	.475"	.415"	19/64"	25 Pcs.
12699PK	10-32	.020-.130"	.296"	.475"	.415"	19/64"	25 Pcs.
12700PK	1/4-20	.027-.165"	.390"	.580"	.500"	25/64"	25 Pcs.
12702PK	5/16-18	.027-.150"	.530"	.690"	.685"	17/32"	10 Pcs.
12704PK	3/8-16	.027-.150"	.530"	.690"	.685"	17/32"	10 Pcs.
12706PK	1/2-13	.063-.200"	.685"	1.150"	.865"	11/16"	5 Pcs.
13411PK	3-.50mm	.50-2.00mm	4.90mm	9.02mm	7.85mm	5mm	25 Pcs.
12674PK	4-.70mm	.50-2.00mm	6.73mm	10.67mm	9.91mm	6.75mm	25 Pcs.
12676PK	5-.80mm	.50-3.30mm	7.52mm	12.07mm	10.54mm	7.60mm	25 Pcs.
12678PK	6-1.00mm	.70-4.20mm	9.91mm	14.73mm	12.70mm	10mm	25 Pcs.
12680PK	8-1.25mm	.70-3.80mm	13.46mm	17.53mm	17.40mm	13.50mm	10 Pcs.
12682PK	10-1.50mm	.70-3.80mm	13.46mm	17.53mm	17.40mm	13.50mm	10 Pcs.

## Nutserts Hex Type

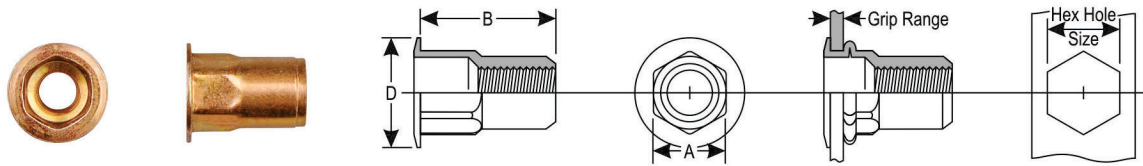

Part #	Thread Size	Grip Range	A	B	D	Drill Size	Qty.
12709PK	6-32	.020 - .080"	.249"	.385"	.375"	1/4"	25 Pcs.
12711PK	8-32	.020 - .080"	.249"	.385"	.375"	1/4"	25 Pcs.
12713PK	10-32	.020 - .130"	.280"	.435"	.390"	9/32"	25 Pcs.
12715PK	1/4-20	.027 - .165"	.374"	.585"	.510"	3/8"	15 Pcs.
12717PK	5/16-18	.027 - .150"	.499"	.685"	.655"	1/2"	10 Pcs.
12719PK	3/8-16	.027 - .150"	.499"	.685"	.655"	1/2"	10 Pcs.
12685PK	4-.70mm	.20 - .30mm	6.35mm	11.05mm	9.53mm	6.35mm	15 Pcs.
10210PK	5-.80mm	.50 - 3.30mm	7.10mm	11.05mm	9.91mm	7.14mm	15 Pcs.
10211PK	6-1.00mm	.70 - 4.20mm	9.50mm	14.86mm	12.96mm	9.53mm	15 Pcs.
12690PK	8-1.25mm	.70 - 3.80mm	12.70mm	17.40mm	16.64mm	12.70mm	15 Pcs.
12692PK	10-1.50mm	.70 - 3.80mm	12.70mm	17.40mm	16.64mm	12.70mm	10 Pcs.

## Nuts Acorn With Brass Insert

**13242PK**  
 4-.70mm Thread Size  
 12mm Flange Diameter  
 10mm Hex Size  
 Black Nylon Coated  
 Acorn Nuts With Brass Insert  
 BMW # 07-13-0-702-715  
 Honda # 75307-SN7-000



**15 Pcs.**



5



# Specialty Nuts



## Nuts Acorn With Washer

<b>15862PK</b>	5mm Stud Size 10mm Hex Size 18.50mm Flange Diameter 10.50mm Overall Height Black Nylon Moulding Flange Nuts Audi # 171-201-969	<b>25 Pcs.</b>		
----------------	--------------------------------------------------------------------------------------------------------------------------------------------------	----------------	------------------------------------------------------------------------------------	-------------------------------------------------------------------------------------

## Nuts Nylon

<b>18841PK</b>	6mm Stud Size 16mm Flange Outside Diameter 10mm Hex Size 10mm Height Black Nylon Fender Liner Self-Threading Flange Nuts Land Rover # RYH5007780	<b>25 Pcs</b>		
----------------	--------------------------------------------------------------------------------------------------------------------------------------------------------------------	---------------	------------------------------------------------------------------------------------	-------------------------------------------------------------------------------------



<b>16445PK</b>	4.20mm Screw Size 20mm Flange Diameter 13.50mm Over All Height White Nylon Bumper Deflector Flange Nuts G.M. # 11547637	<b>25 Pcs.</b>		
----------------	----------------------------------------------------------------------------------------------------------------------------------------	----------------	------------------------------------------------------------------------------------	-------------------------------------------------------------------------------------



<b>17074PK</b>	#8 (4.20mm) Screw Size 20mm Flange Diameter 10mm Hex Size Black Nylon Wheelhouse Liner Nuts G.M. # 11612034	<b>25 Pcs.</b>		
----------------	----------------------------------------------------------------------------------------------------------------------------	----------------	-------------------------------------------------------------------------------------	--------------------------------------------------------------------------------------

<b>16367PK</b>	4.8-1.61mm Screw 30mm Flange Diameter 10mm Hex Size Black Nylon Fender Liner, Apron, & Under Cover Hex Flange Nuts Mercedes # 000-990-31-62	<b>25 Pcs.</b>		
----------------	---------------------------------------------------------------------------------------------------------------------------------------------------------------	----------------	--------------------------------------------------------------------------------------	---------------------------------------------------------------------------------------

<b>18840PK</b>	6mm Screw Size 10mm Hex Size Size 15mm Height 30mm Flange Diameter Black Nylon Splash Shield Nuts Ford # W719534-S300	<b>25 Pcs.</b>		
----------------	-----------------------------------------------------------------------------------------------------------------------------------------	----------------	--------------------------------------------------------------------------------------	---------------------------------------------------------------------------------------

## Nuts Jack

<b>1282PK</b>	1/4-20 Thread Size 11/16" Stem Length 1/64 - 3/16" Grip Range Without Sealer Steel Jack Nuts	<b>25 Pcs.</b>		
---------------	----------------------------------------------------------------------------------------------------------	----------------	--------------------------------------------------------------------------------------	---------------------------------------------------------------------------------------

<b>9371PK</b>	1/4-20 Thread Size 5/8" Stem Length 3/16" - 3/8" Grip Range Raintite Sealer Type Steel Jack Nuts Chrysler # 6031438 G.M. # 367292	<b>25 Pcs.</b>		
---------------	-----------------------------------------------------------------------------------------------------------------------------------------------------	----------------	--------------------------------------------------------------------------------------	---------------------------------------------------------------------------------------

5











# Specialty Nuts

## Nuts Jack

<b>9541PK</b>	1/4-20 x 1" 5/8" Outside Diameter Chrome Finish Outside Mirror Mounting Bolts Use With # 9371 G.M. # 367291, 10001670, 474821	<b>25 Pcs.</b>		
<b>1793PK</b>	6-1.00mm Thread Size Roof Rack Mounting Raintite Sealer Type Steel Jack Nuts G.M. # 14007940	<b>10 Pcs.</b>		
<b>1589PK</b>	6-1.00 x 26.00mm Chrome Finish Outside Mirror Mounting Bolts Use With # 1793 Ford # N801851-S, N800928-S45, N806345-S47, N806345-S433	<b>25 Pcs.</b>		
<b>9561PK</b>	1/4-20 x 1" Screw Size Mirror Mounting Screw & Jack Nut Assembly G.M. # 367292	<b>10 Sets</b>		

5

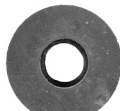
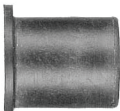
## Nuts Brass Insert Rubber Well

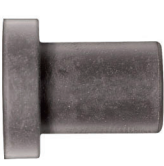
<b>10035PK</b>	8-32 Screw Size 5/16" Hole Size 7/16" Length .015 - .178" Grip Range Black Rubber With Brass Insert Well Nuts G.M. # 14048060	<b>25 Pcs.</b>		
<b>15953PK</b>	10-24 Screw Size 3/8" Hole Size 37/64" Length .030 - .227" Grip Range Black Rubber With Brass Insert Well Nuts G.M. # 3876130	<b>25 Pcs.</b>		
<b>9891PK</b>	10-32 Screw Size 3/8" Hole Size 33/64" Length .015 - .192" Grip Range Black Rubber With Brass Insert Well Nuts	<b>25 Pcs.</b>		
<b>11284PK</b>	10-32 Screw Size 3/8" Hole Size 5/8" Length .035 - .232" Grip Range Black Rubber With Brass Insert Well Nuts G.M. # 12338025	<b>10 Pcs.</b>		
<b>1095PK</b>	1/4-20 Screw Size 1/2" Hole Size 19/32" Length .015 - .111" Grip Range Black Rubber With Brass Insert Well Nuts AMC # 4003120 Chrysler # 2094869, 6033705 G.M. # 528846, 342271	<b>25 Pcs.</b>		
<b>11386PK</b>	1/4-20 Screw Size 1/2" Hole Size 41/64" Length 3/4" Head size Black Rubber With Brass Insert Well Nuts	<b>10 Pcs.</b>		

# Specialty Nuts

## Nuts Brass Insert Rubber Well

**12836PK**      5/16-18 Screw Size  
5/8" Hole Size  
19/32" Length  
27/32" Flange  
.015 - .156" Grip Range  
Black Rubber With Brass Insert Well Nuts

**15 Pcs.**



**1284PK**      6-1.00mm Screw Size  
12.70mm Hole Size  
14.50mm Length  
.015 - .111" Grip Range  
Black Rubber With Brass Insert Well Nuts  
AMC # 8934201293  
G.M. # 15505451

**10 Pcs.**



**11899PK**      6-1.00mm Screw Size  
12.70mm Hole Size  
15mm Length  
20mm Flange Diameter  
.015 - .094" Grip Range  
Roof Rack Mounting  
Black Rubber Well Nuts  
G.M. # 20130258, 14002811

**10 Pcs.**



5

## Kits Brass Insert Rubber Well Nut

**13363**      6-1.00mm Screw Size  
1/2" Hole Size  
Screw, Washer & Nut  
Top Carrier  
Black Rubber With Brass Insert  
Well Nuts Anchor Kit

**10 Sets**



## Nuts Square Type Cage Standard



Part #	Screw Size	Panel Range	Mounting Hole	Finish	Qty.
11005PK	10-24	.025" - .063"	3/8"	Zinc	50 Pcs.
11006PK	10-24	.064" - .105"	3/8"	Zinc	50 Pcs.
11007PK	10-32	.025" - .063"	3/8"	Zinc	50 Pcs.
11008PK	10-32	.064" - .105"	3/8"	Zinc	50 Pcs.
11009PK	1/4-20	.025" - .063"	3/8"	Zinc	50 Pcs.
11010PK	1/4-20	.064" - .105"	3/8"	Zinc	50 Pcs.
11011PK	5/16-18	.093" - .126"	1/2"	Zinc	50 Pcs.
11012PK	3/8-16	.093" - .126"	1/2"	Zinc	50 Pcs.

## Nuts Square Type Cage Metric



Part #	Screw Size	Panel Range	Mounting Hole	Finish	Qty.
11013PK	5-.80mm	1.626" - 2.667"	3/8"	Zinc	50 Pcs.
11014PK	6-1.00mm	.635" - 1.60"	3/8"	Zinc	50 Pcs.
11015PK	6-1.00mm	1.626" - 2.667"	3/8"	Zinc	50 Pcs.

# Specialty Nuts

## Nuts Air Cleaner Wing

### 10243PK

1/4 (6.30mm) Screw Size  
Natural Nylon  
Air Cleaner Hold Down  
Wing Nuts  
Ford # 386285 AMC # 3230375

10 Pcs.



### 10245PK

1/4-20 Screw Size  
Black Nylon  
Air Cleaner Hold Down  
Wing Nuts  
Chrysler # 5240734

10 Pcs.



5