







# General Motors





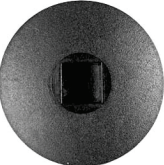

# General Motors

## Screws Square Drive Truss Head Black Nylon

<b>10566PK</b>	14.00 x 34.00mm #3 Square Drive Truss Head 22mm Head Diameter Black Nylon Bumper & Door Insulator Screws G.M. # 11561438	<b>25 Pcs.</b>		
<b>10539PK</b>	7.50 x 35.00mm #3 Square Drive Truss Head 22mm Head Diameter Black Nylon Bumper Fascia Screws Chrysler # 6503819, 6503401 G.M. # 25631448	<b>15 Pcs.</b>		
<b>11178PK</b>	9.20 x 45.00mm #3 Square Drive Truss Head 22mm Head Diameter Black Nylon Bumper Fascia Screws G.M. # 25705182	<b>15 Pcs.</b>		

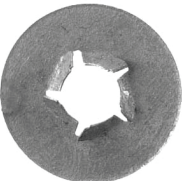
## Nuts Push On Type Threaded Stud Metric

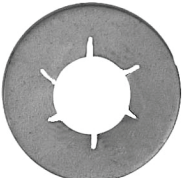
<b>1621PK</b>	6-1.00mm Screw Size 17mm Outside Diameter Flange Zinc Plated Push On Type Retainers Chrysler # 6501178, 6501192 Ford # N801192S36 G.M. # 11503736, 11609738, 14093869	<b>100 Pcs.</b>	
<b>1043PK</b>	8-1.25mm Screw Size 16mm Outside Diameter Flange Zinc Finish Push On Type Retainers Chrysler # 6501025 G.M. # 11502504, 11502853	<b>100 Pcs.</b>	
<b>3010PK</b>	8-1.25mm Screw Size 24mm Outside Diameter Flange Zinc Finish Bumper Strip Retainers Chrysler # 6501825 G.M. # 10009923	<b>50 Pcs.</b>	
<b>9335PK</b>	10 x 1.50mm Screw Size 20mm Outside Diameter Flange Black Finish Push On Type Retainers G.M. # 11502759	<b>50 Pcs.</b>	
<b>1276PK</b>	10-1.50mm Screw Size 24mm Outside Diameter Flange Dacromet Finish Push On Type Retainers G.M. # 11501849	<b>50 Pcs.</b>	

# General Motors

## Nuts Push On Type Threaded Stud Metric

**1044PK** 12-1.75mm Screw Size  
21.40mm Outside Diameter Flange  
Black Finish  
Push On Type Retainers  
G.M. # 11502737



**9952PK** 14-2.00mm Screw Size  
25mm Outside Diameter Flange  
Black Finish  
Push On Type Retainers  
G.M. # 11504119

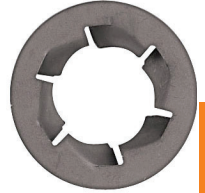

18

## Retainers Grommet

**16447PK** 11/64" (4.50) Hole Size  
5mm Stem Length  
28mm Head Diameter  
Black Nylon  
Bumper Cover Grommets  
G.M. # 15265199



**16450PK** 5mm Stud  
25/64" (10mm) Hole Size  
8mm Stem Length  
30mm Head Diameter  
Black Nylon  
Wheel House Liner Retainers  
GM # 94530387



**16446PK** 28mm Top Diameter  
17.50mm Bottom Diameter  
23mm Overall Height  
Black Nylon  
Body Mount Cushion Sleeves  
G.M. # 15924986

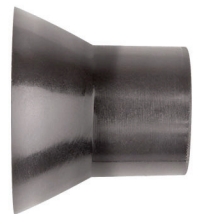
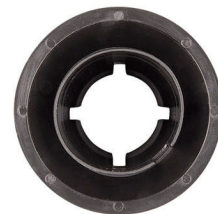

## Nuts Push On Type Non-Threaded Stud Metric

**9850PK** 3.20mm Stud Size  
9.50mm Outside Diameter Flange  
Zinc Finish  
Push On Type Retainers  
G.M. # 11502794



**1691PK** 4mm Stud Size  
11mm Outside Diameter Flange  
Black Finish  
Push On Type Retainers  
G.M.



# General Motors

## Nuts Thread Cutting Metric

<b>1041PK</b>	5mm Stud Size 10mm Hex Size 15mm Flange Diameter Black Finish Thread Cutting Nuts G.M. # 11501835, 11508900, 11510062, 11501932	<b>50 Pcs.</b>		
<b>1042PK</b>	6.30mm Stud Size 11mm Hex Size 18mm Flange Diameter Zinc Finish Thread Cutting Nuts G.M. # 11501836, 11503432	<b>50 Pcs.</b>		
<b>1622PK</b>	8mm Stud Size 13mm Hex Size 20mm Flange Diameter Zinc Finish Thread Cutting Nuts G.M. # 11502507, 11509535, 11514282	<b>100 Pcs.</b>		

## Nuts Lock Zinc Plated

<b>11140PK</b>	6-1.00mm Stud Size 11mm Hex Size 24mm Flange Diameter Metallic Gray Finish with Sealer Locking Washer Nuts G.M. # 11505865	<b>25 Pcs.</b>		
----------------	---	----------------	--	--

## Nuts Hex Loose Washer Standard

<b>17921PK</b>	1/4 - 20 Screw Size 7/16" Hex Size 5/8" Outside Diameter Loose Washer Yellow Zinc Finish Hex Nuts G.M. # 3866846 Ford # 385400, 45334 Chrysler # 6023204, 6025004, 6033560	<b>50 Pcs.</b>		
----------------	---	----------------	--	--

## Nuts Nylon

<b>16445PK</b>	4.20mm Screw Size 20mm Flange Diameter 13.50mm Over All Height White Nylon Bumper Deflector Flange Nuts G.M. # 11547637	<b>25 Pcs.</b>		
<b>17074PK</b>	#8 (4.20mm) Screw Size 20mm Flange Diameter 10mm Hex Size Black Nylon Wheelhouse Liner Nuts G.M. # 11612034	<b>25 Pcs.</b>		



## Nuts Hex Flange Type Metric

<b>5797PK</b>	5-.80mm Screw Size 8mm Hex Size 11.80mm Outside Diameter Flange Black Finish Metric Hex Flange Nuts G.M. # 11502722, 11502702	<b>50 Pcs.</b>		
---------------	--	----------------	--	--

18



# General Motors

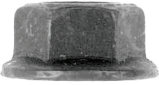

## Nuts Hex Flange Type Metric



<b>11191PK</b>	8-1.25mm Screw Size 13mm Hex Size 17mm Outside Diameter Flange Black Finish Metric Hex Flange Nuts G.M. # 11501889, 11507036, 11502609, 11514518, 11514596	<b>25 Pcs.</b>		
----------------	--	----------------	---	---



<b>1017PK</b>	10-1.50mm Screw Size 15mm Hex Size 21mm Outside Diameter Flange Black Finish Metric Hex Flange Nuts G.M. # 11501850	<b>25 Pcs.</b>		
---------------	--	----------------	---	---



## Nuts Hex Loose Washer Metric

<b>1639PK</b>	5-.80mm Screw Size 10mm Hex Size 15mm Outside Diameter Loose Washer Black Finish Metric Hex Nuts AMC # 4200408 Ford # N621903-S61, N621903-S2 G.M. # 11504614	<b>50 Pcs.</b>		
---------------	--	----------------	---	---



<b>12892PK</b>	5-.80mm Screw Size 10mm Hex Size 19mm Outside Diameter Loose Washer Black Finish Metric Hex Nuts G.M. # 11504614	<b>50 Pcs.</b>		 <b>NEW!</b>
----------------	---	----------------	---	---

<b>5910PK</b>	6-1.00mm Screw Size 10mm Hex Size 16mm Outside Diameter Loose Barbed Washer Black Finish Metric Hex Nuts G.M. # 11505329, 11503752 V.W. # N90100001	<b>25 Pcs.</b>		
---------------	--	----------------	---	---

<b>11896PK</b>	6-1.00mm Screw Size 11mm Hex Size 19mm Outside Diameter Loose Barbed Washer Black Finish Metric Hex Nuts G.M. # 11503754, 11503756, 11505005, 11517293, 11609411	<b>25 Pcs.</b>		
----------------	--	----------------	---	---







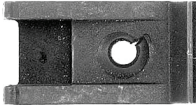

<b>5916XPK</b>	8-1.25mm Screw Size 13mm Hex Size 24mm Outside Diameter Loose Barbed Washer Black Finish Metric Hex Nuts Ford # N621940-S424 G.M. # 11503695, 11506117, 11516780, 11500401	<b>25 Pcs.</b>		
----------------	---	----------------	--	---

## Nuts Speed Type "U" for Sheet Metal Screws

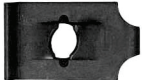

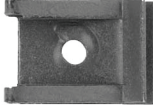
<b>1350PK</b>	#8 (4.20mm) Screw Size .025 - .150" Panel Range 3/8" Center of Hole to Edge Black Finish Speed Type "U" Nuts Ford # 381818-S2, 15650655 G.M. # 9424837, 9431530, 15650655	<b>100 Pcs.</b>		
---------------	---	-----------------	---	---

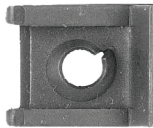
# General Motors









## Nuts Speed Type "U" for Sheet Metal Screws

<b>5750PK</b>	#8 (4.20mm) Screw Size .025 - .150" Panel Range 5/8" Center of Hole to Edge Black Finish Speed Type "U" Nuts Ford # 381863-S2 G.M. # 9440178, 9433155, 11504531	<b>100 Pcs.</b>		
<b>11040PK</b>	#8 (4.20mm) Screw Size .045 - .062" Panel Range 3/8" Center Of Hole To Edge Black Finish Speed Type "U" Nuts G.M. # 445429, 9422552	<b>50 Pcs.</b>		
<b>1510PK</b>	#8 (4.20mm) Screw Size .125 - .250" Panel Range 3/8" Center of Hole to Edge Black Finish Speed Type "U" Nuts G.M. # 9433156	<b>100 Pcs.</b>		
<b>1192PK</b>	#14 (6.30mm) Screw Size .025 - .150" Panel Range 3/8" Center of Hole to Edge Black Finish Speed Type "U" Nuts G.M. # 9431532	<b>25 Pcs.</b>		

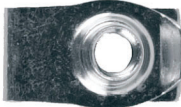
## Nuts Speed Type "U" for Machine Screws



<b>9848PK</b>	1/4-20 Screw Size .064 - .125" Panel Range 9/16" Center of Hole to Edge Black Finish Speed Type "U" Nuts G.M. # 9431647, 22529733	<b>100 Pcs.</b>		
---------------	--	-----------------	---	---

## Nuts Extruded Type "U" Standard

<b>938PK</b>	10-24 Screw Size .025 - .125" Panel Range 15/32" Center of Hole to Edge Black Finish Extruded "U" Nuts Chrysler # 149251 G.M. # 152273	<b>50 Pcs.</b>		
<b>2969PK</b>	1/4-20 Screw Size .010 - .165" Panel Range 17/32" Center of Hole to Edge Black Finish Extruded "U" Nuts Ford # 45263-S2 G.M. # 1494252, 1480627	<b>25 Pcs.</b>		
<b>5480PK</b>	1/4-20 Screw Size .010 - .165" Panel Range 25/32" Center of Hole to Edge Black Finish Extruded "U" Nuts Ford # 45267 G.M. # 1494257	<b>25 Pcs.</b>		
<b>1835PK</b>	5/16-18 Screw Size .025 - .125" Panel Range 5/8" Center of Hole to Edge Black Finish Extruded "U" Nuts Chrysler # 3786805 G.M. # 1494253	<b>25 Pcs.</b>		

# General Motors



## Nuts Extruded Type "U" Standard

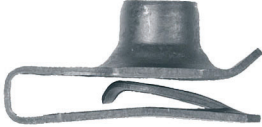

<b>1836PK</b>	5/16-18 Screw Size .010 - .170" Panel Range 27/32" Center of Hole to Edge Black Finish Extruded "U" Nuts Ford # 379831-S G.M. # 1494258	25 Pcs.		
---------------	---	---------	--	---



<b>5412PK</b>	3/8-16 Screw Size .035 - .205" Panel Range 3/4" Center of Hole to Edge Black Finish Extruded "U" Nuts Ford # 45265-S2 G.M. # 1494254, 12337873	25 Pcs.		
---------------	--	---------	--	---

## Nuts Extruded Type "U" Metric

<b>10726PK</b>	#8 (4.20-1.41mm) Screw Size .50 - 2.00mm Panel Range 10mm Center of Hole to Edge Zinc Organic Prevailing Torque Extruded "U" Nuts G.M. # 11516397	50 Pcs.		
----------------	--	---------	---	---



<b>10795PK</b>	#8 (4.20-1.41mm) Screw Size .65 - 3.80mm Panel Range 9.50mm Center of Hole to Edge Zinc Organic Prevailing Torque Extruded "U" Nuts G.M. # 11513599 Ford # W704823-S439	25 Pcs.		
----------------	---	---------	---	---

<b>11043PK</b>	#8 (4.20-1.41mm) Screw Size .65 - 3.80mm Panel Range 15mm Center of Hole To Edge Zinc Organic Prevailing Torque Extruded "U" Nuts G.M. # 11515638	25 Pcs.		
----------------	--	---------	---	--

<b>11339PK</b>	#8 (4.20-1.41mm) Screw Size 2.00 - 3.00mm Panel Range 10.10mm Center of Hole to Edge Prevailing Torque 6.28 In-lbs Black Finish Extruded "U" Nuts G.M. # 11513700	25 Pcs.		
----------------	---	---------	---	---

















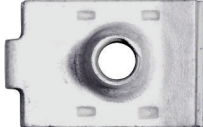



<b>16078PK</b>	#8 (4.20-1.41mm) Screw Size 2.00 - 3.00mm Panel Range 9.50mm Center of Hole to Edge Zinc Organic Extruded "U" Nuts G.M. # 11548579	25 Pcs.		
----------------	---	---------	---	---

<b>1021PK</b>	4-.70mm Screw Size .80 - 4.00mm Panel Range 13.50mm Center of Hole to Edge Black Finish Extruded "U" Nuts G.M. # 11500655	50 Pcs.		
---------------	--	---------	--	---

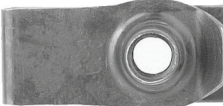
<b>12893PK</b>	5-.80mm Screw Size .60 - 3.80mm Panel Range 11mm Center of Hole To Edge Black Finish Extruded "U" Nuts Ford # N623331-S2, W520821-S439, W520821-S426 G.M. # 11505596, 11500656	50 Pcs.		
----------------	---	---------	--	---



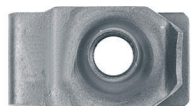



# General Motors

## Nuts Extruded Type "U" Metric



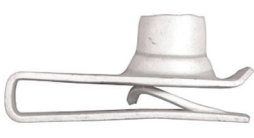

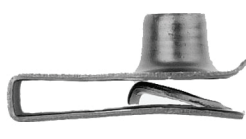
<b>1012PK</b>	5-.80mm Screw Size .80 - 4.00mm Panel Range 8mm Center of Hole to Edge Black Finish Extruded "U" Nuts G.M. # 11500657, 11504693	<b>50 Pcs.</b>		
<b>16400PK</b>	6-1.00mm Screw Size 1.80 - 2.50mm Panel Range 9mm Center of Hole to Edge Zinc Finish Extruded "U" Nuts Ford # N806728-S439 G.M. # 11517841	<b>15 Pcs.</b>		
<b>9949PK</b>	6-1.00mm Screw Size .50 - 2.30mm Panel Range 14mm Center of Hole to Edge G.M. #4435-M Finish Prevailing Torque Extruded "U" Nuts G.M.	<b>25 Pcs.</b>		
<b>16081PK</b>	6-1.00 Screw Size .70 - 2.00mm Panel Range 14mm Center of Hole to Edge Zinc Organic Extruded "U" Nuts G.M. # 11611321	<b>10 Pcs.</b>		
<b>11030PK</b>	6-1.00mm Screw Size .80 - 2.00mm Panel Range 14mm Center of Hole to Edge Zinc Organic Extruded "U" Nuts G.M. # 11570097	<b>15 Pcs.</b>		
<b>10836PK</b>	6-1.00mm Screw Size .80 - 4.00mm Panel Range 13.50mm Center of Hole to Edge Black Phosphate Organic Finish Prevailing Torque Extruded "U" Nuts Chrysler # 6101308 Ford # N800854-S1 G.M. # 11509005	<b>25 Pcs.</b>		
<b>5596PK</b>	6-1.00mm Screw Size .80 - 4.00mm Panel Range 13.50mm Center of Hole to Edge Black Finish Extruded "U" Nuts Ford # N623332, N623332-S2, N623332-S53, N623332-S100 G.M. # 11503957, 11503716, 1016937	<b>25 Pcs.</b>		
<b>5650PK</b>	6-1.00mm Screw Size 1.00 - 2.50mm Panel Range 19.50mm Center of Hole to Edge Black Finish Extruded "U" Nuts Ford # W520832-S424, W520832-S426 G.M. # 11503715, 11506099, 11508241	<b>25 Pcs.</b>		
<b>9512PK</b>	6-1.00mm Screw Size 3.40 - 6.30mm Panel Range 13.50mm Center of Hole to Edge Black Finish Extruded "U" Nuts Ford # N802331-S53 G.M. # 11504047	<b>25 Pcs.</b>		
<b>5559PK</b>	6.30-1.00mm Screw Size .80 - 4.00mm Panel Range 13.50mm Center of Hole to Edge Black Finish Extruded "U" Nuts G.M. # 11500658, 9433043, 11502785	<b>25 Pcs.</b>		

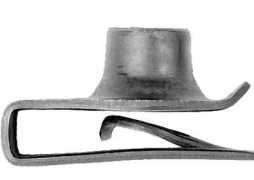
# General Motors



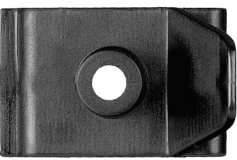

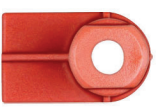
## Nuts Extruded Type "U" Metric

<b>5560PK</b>	8-1.25mm Screw Size .80 - 4.00mm Panel Range 14.50mm Center of Hole to Edge Black Finish Extruded "U" Nuts Chrysler # 6100042, 6101283 Ford # N623333-S2, N623333-S100 G.M. # 11500660, 11508925, 11502617	<b>25 Pcs.</b>		
<b>16080PK</b>	8-1.25 Screw Size .80 - 4.30mm Panel Range 21mm Center of Hole to Edge Zinc Organic Extruded "U" Nuts Ford # W520813-S439 G.M. # 11516150	<b>15 Pcs.</b>		
<b>5557PK</b>	8-1.25mm Screw Size .80 - 4.50mm Panel Range 20mm Center of Hole to Edge Black Finish Extruded "U" Nuts Ford # N623343-S100, N623343-S2 G.M. # 11500661, 11503317, 11516150	<b>25 Pcs.</b>		
<b>5558PK</b>	10-1.50mm Screw Size .90 - 6.00mm Panel Range 19mm Center of Hole to Edge Black Finish Extruded "U" Nuts G.M. # 11500662, 22531616	<b>25 Pcs.</b>		

## Nuts Nylon Type "U" Metric

















<b>1601PK</b>	#10 (4.80mm) Screw Size Up to 1.00mm Panel Range 11mm Center of Hole to Edge Black Nylon Fender Wheel Housing "U" Type Nuts G.M. # 94841226 Mazda LA01-56-135 Toyota # 53879-14010-A, 53879-14020, 53879-22030	<b>15 Pcs.</b>		
<b>15729PK</b>	#12 (5.50mm) Screw Size Up To 2.00mm Panel Range 12mm Center Of Hole to Edge Red Nylon "U" Type Nuts G.M. # 24449408	<b>25 Pcs.</b>		

## Nuts Nylon

<b>11193PK</b>	#6 (3.50mm) Screw Size 6.50mm Stem Length 9.60mm Head Size 6.00 x 6.50mm Hole Size Natural Nylon With Sealer Rear Bumper Grommets G.M. # 11589183	<b>50 Pcs.</b>		
<b>1297PK</b>	#6 (3.50mm) Screw Size 5/16" Stem Length 13/32" Head Size 9/32" Hole Size Natural Nylon Headlight Screw Grommets Chrysler # 6029501 G.M. # 1370853 V.W. # 179-813-883, 155-809-966	<b>50 Pcs.</b>		















# General Motors

## Nuts Nylon

<b>9873PK</b>	#6 (3.50mm) Screw Size 8mm Stem Length 12.50mm Head Diameter 7.00 x 7.50mm Hole Size Natural Nylon Headlight Door to Radiator Grille Grommets G.M. # 1355003	<b>50 Pcs.</b>		
<b>9111PK</b>	#6 (3.50mm) Screw Size 8.50mm Stem Length 10mm Head Size 6.50 x 7.50mm Hole Size Natural Nylon Headlight Screw Grommets AMC # 400141 G.M. # 380382 Mitsubishi # MS480001	<b>50 Pcs.</b>		
<b>1202PK</b>	#6 (3.50mm) Screw Size 8.50mm Stem Length 13.00 x 17.00mm Head Size 7.00 x 15.00mm Hole Size Natural Nylon Grille Attachment Screw Grommets G.M. # 14032291	<b>50 Pcs.</b>		
<b>637PK</b>	#6 (3.50mm) Screw Size 9mm Stem Length 14.00 x 21.00mm Head Size 7.00 x 18.50mm Hole Size Natural Nylon Rear Bumper Bar Screw Grommets G.M. # 1377030	<b>100 Pcs.</b>		
<b>9085PK</b>	#6 (3.50mm) Screw Size 3/8" Stem Length 15/64 x 23/64" Head Size 15/64" Hole Size White Nylon Marker Light Screw Grommets G.M. # 1254815	<b>50 Pcs.</b>		
<b>1407PK</b>	#6 (3.50mm) Screw Size 16.50mm Stem Length 14.70 x 20.80mm Head Size 7.10 x 20.30mm Hole Size Black Nylon High Torque Screw Grommets AMC # 8934-201-602 Chrysler # 6031869 G.M. # 10032838, 1264963	<b>25 Pcs.</b>		
<b>11863PK</b>	#6 to #8 Screw Size 8.30mm Stem Length 11.00 x 13.60mm Head Size Black Nylon Cowl Vent Nuts Chrysler # 6035274 G.M. # 15596280	<b>25 Pcs.</b>		
<b>2940PK</b>	#8 (4.20mm) Screw Size 17/64" Stem Length 31/64" Head Size 5/16" Hole Size Natural Nylon Headlamp Screw Grommets G.M. # 14013246	<b>50 Pcs.</b>		

# General Motors



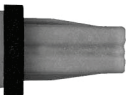











## Nuts Nylon

<b>9050PK</b>	#8 (4.20mm) Screw Size 17/64" Stem Length 17/32" Head Size 11/32" Hole Size Natural Nylon Grille Screw Grommets G.M.	<b>50 Pcs.</b>		
<b>1574PK</b>	#8 (4.20mm) Screw Size 9/32" Stem Length 7/16" Head Size 5/16" Hole Size Natural Nylon Grille Screw Grommets G.M. # 3919773, 22649878, 22649879	<b>100 Pcs.</b>		
<b>2980PK</b>	#8 (4.20mm) Screw Size 9/32" Stem Length 7/16" Head Size 5/16" Hole Size Natural Nylon Grille Screw Grommets G.M. # 3893980, 347347	<b>50 Pcs.</b>		
<b>1997PK</b>	#8 (4.20mm) Screw Size 8mm Stem Length 13mm Head Diameter 7.50mm Hole Size Black Nylon Tail Light Screw Grommets G.M. # 3997391 V.W. # 179-813-881	<b>25 Pcs.</b>		
<b>12667PK</b>	#8 (4.20mm) Screw Size 8.50mm Stem Length 9.70mm Head Diameter 6.50 x 7.50mm Hole Size Natural Nylon With Sealer Screw Grommets G.M. # 9669486 Renault # 8934-201-262	<b>25 Pcs.</b>		
<b>10553PK</b>	#8 (4.20mm) Screw Size 13/32" Stem Length 1/2 x 21/32" Head Size 19/64 x 15/32" Hole Size Black Nylon Door Panel & Fender Shield Screw Grommets Chrysler # 6035821 G.M. # 11517759	<b>25 Pcs.</b>		
<b>10556PK</b>	#8 (4.20mm) Screw Size 11mm Stem Length 10mm Head Size 6.70mm Hole Size Natural Nylon Door Reveal Screw Grommets Ford # W710362 G.M. # 25647358	<b>25 Pcs.</b>		
<b>11202PK</b>	#8 (4.20mm) Screw Size 16mm Stem Length 12mm Head Size 7mm Hole Size Natural Nylon With Sealer Bumper Cover Grommets G.M. # 11561847	<b>25 Pcs.</b>		

18

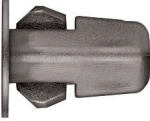













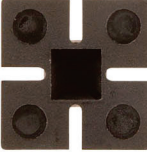



# General Motors

## Nuts Nylon

<b>10552PK</b>	#8 (4.20mm) Screw Size 18mm Stem Length 13.00 x 22.00mm Head Diameter 6.00 x 16.50mm Hole Size Natural Nylon With Sealer Back Glass Moulding & Interior Trim Screw Grommets Ford # W705590-S300, W710459-S300 G.M. # 25649667	<b>15 Pcs.</b>		
<b>15829PK</b>	#10 (4.80mm) Screw Size 8mm Stem Length 13mm Head Diameter 8mm Hole Size White Nylon License Plate Grommets G.M. # 3783006	<b>50 Pcs.</b>		
<b>17945PK</b>	#10 (4.80mm) Screw Size 11mm Stem Length 9.50mm Head Diameter Natural Nylon Lower Door & Handle Interior Trim Grommets G.M. # 90230846, 94515248	<b>25 Pcs.</b>		
<b>1560PK</b>	#10 (4.80mm) Screw Size 11mm Stem Length 12mm Head Size 8 x 9mm Hole Size Natural Nylon Grille Screw Grommets G.M. # 94841764 Mitsubishi # MS480002, MS480009 Toyota # 90189-05013	<b>50 Pcs.</b>		
<b>10551PK</b>	#12 (5.50mm) Screw Size 9/16" Stem Length 5/8 x 3/4" Head Size 11/32 x 1/2" Hole Size Natural Nylon Door Handle Screw Grommets G.M. # 11517873	<b>15 Pcs.</b>		
<b>9912PK</b>	#12 (5.50mm) Screw Size 19mm Stem 16mm Head 8mm Square Hole Size Black Nylon Front & Rear Wheel Fender Liner Screw Grommets G.M. # 94854203 Toyota # 90189-06028	<b>15 Pcs.</b>		
<b>9872PK</b>	#14 (6.30mm) Screw Size 8mm Stem Length 14.30mm Head Diameter 8.50mm Hole Size Natural Nylon License Plate Screw Grommets G.M. # 380370	<b>50 Pcs.</b>		
<b>1228PK</b>	#14 (6.30mm) Screw Size 5/16" Stem Length 5/8" Head Size 13/32" Hole Size White Plastic License Plate Nuts Chrysler # 6023925 G.M. # 3907444	<b>50 Pcs.</b>		

# General Motors









## Nuts Nylon

<b>17927PK</b>	#14 (6.30mm) Screw Size 8mm Stem Length 16mm Head Size Black Nylon With Sealer Bumper, License Plate & Tail Light Screw Grommets G.M. # 25832258	<b>10 Pcs.</b>		
<b>12664PK</b>	#14 (6.30mm) Screw Size 11mm Stem Length 15mm Head Diameter 9.50mm Hole Size Natural Nylon Screw Grommets G.M. # 4755299	<b>50 Pcs.</b>		
<b>10525PK</b>	#14 (6.30mm) Screw Size 14mm Stem Length 20mm Head Size 8mm Hole Size Black Nylon License Plate Grommets G.M. # 22546934	<b>50 Pcs.</b>		
<b>10550PK</b>	#14 (6.30mm) Screw Size 17mm Stem Length 24mm Head Size 15mm Hole Size Black Nylon With Sealer Light Housing Screw Grommets G.M. # 15745990, 15289020, 11609535	<b>15 Pcs.</b>		
<b>11391PK</b>	#14 (6.30mm) Screw Size 23mm Stem Length 15.00 x 18.00mm Head Size White Nylon With Sealer Rear Bumper Screw Grommets G.M. # 25704358	<b>10 Pcs.</b>		
<b>18261PK</b>	4.80mm Stud Size 17mm Head Diameter 9.80mm Hole Size Black Rubber Tail Lamp Grommet G.M. # 11571225	<b>10 Pcs.</b>		
<b>15816PK</b>	25/64" (10mm) Hole Size 15mm Stem Length 18mm Head Diameter White Nylon With Sealer Tail Light Grommets G.M. # 22884291	<b>10 Pcs.</b>		
<b>16309PK</b>	25/64" (10mm) Hole Size 17.50mm Overall Length 19mm Head Diameter Orange Nylon With Sealer Tail Lamp Grommets G.M. # 84221533	<b>10 Pcs.</b>		
<b>9712PK</b>	7/16" (11mm) Hole Size 9mm Stem Length 13mm Head Diameter White Nylon Park & Turn Signal Grommets Ford # N811169-S, W705550-S300 G.M. # 10423331 Toyota # 90075-10801, 90189-06111	<b>50 Pcs.</b>		



18

# General Motors

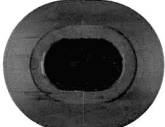
## Nuts Nylon





















<b>13368PK</b>	7/16" (11mm) Hole Size 16mm Stem Length 16mm Head Diameter White Nylon Fog Light Grommets G.M. # 11570830	<b>15 Pcs.</b>		
<b>11162PK</b>	19/32" (15mm) Hole Size 21mm Stem Length 24mm Head Diameter .90mm Thick Panel Black Nylon With Sealer Tail Light Grommets G.M. # 11561987	<b>15 Pcs.</b>		
<b>10554PK</b>	13 x 20mm Head Size 17mm Stem Length 9.00 x 16.00mm Hole Size Black Nylon Rear Light Housing Screw Grommets Chrysler # 5113360-AA G.M. # 15284612, 11609536, 15745991	<b>15 Pcs.</b>		
<b>10498PK</b>	13 x 20mm Head Size 17.50mm Stem Length 8.75 x 15.75mm Hole Size Blue Nylon With Sealer Headlight Screw Grommets G.M. # 11561382, 11610198	<b>10 Pcs.</b>		
<b>10526PK</b>	15mm Head Diameter 17mm Stem Length 11mm Hole Size Black Nylon With Sealer Tail Light Grommets G.M. # 11561655, 11609862, 11610705	<b>5 Pcs.</b>		
<b>11189PK</b>	9.50 x 13.50mm Hole Size 18mm Stem Length 17.50 x 21.50mm Head Size Black Nylon Fascia Grommets Use With #11190 G.M. # 22603044	<b>15 Pcs.</b>		
<b>11190PK</b>	5mm Pin Diameter 19.70mm Pin Length 3.30mm Panel Range Black Nylon Front Bumper Fascia Hinged Pin Retainers Use With #11189 G.M. # 22615352, 11588782, 22603043	<b>15 Pcs.</b>		

## Nuts Miscellaneous Metric

<b>12273PK</b>	#6 (3.50mm) Screw Size 10mm Width 18mm Overall Height Zinc Finish Bumper & Grille Fasteners Chrysler # 4806226-AA, 68004187-AA Ford # W710754-S439 G.M. # 11562364	<b>15 Pcs.</b>		
----------------	---	----------------	--	---

# General Motors



## Nuts Miscellaneous Metric



<b>9199PK</b>	#8 (4.20mm) Screw Size Zinc Finish Radiator Grille Nuts Ford # N802865-S100 G.M. # 15686142, 11561448	<b>25 Pcs.</b>		
<b>11258PK</b>	#8 (4.20mm) Screw Size 8.65mm Hole Size Zinc Finish Fender Bracket Push In Nuts G.M. # 11518531, 11609952	<b>15 Pcs.</b>		
<b>12983PK</b>	#8 (4.20mm) Screw Size 6.00 x 16.00mm Head Size 7mm Overall Height Magni-565 Finish Front Bumper Nuts G.M. # 11609952	<b>25 Pcs.</b>		
<b>16065PK</b>	#8 (4.20mm) Screw Size .50 - 1.00mm Panel Range 8.55mm Square Hole Size Green Finish With Silicone Pad Door Panel & Bumper Nuts G.M. # 11546868	<b>15 Pcs.</b>		
<b>11032PK</b>	#8 (4.20mm) Screw Size .70 - 2.30mm Panel Range 8.70mm Hole Size Blue Finish Mid Panel Nuts Chrysler # 6509432AA Ford # W716529-S900 G.M. # 1570654	<b>25 Pcs.</b>		
<b>10733PK</b>	#8 (4.20mm) Screw Size .70 - 1.50mm Panel Range 8.70mm Hole Size Gray Finish With Sealer Tail Light Quarter Panel Nuts Ford # W714171-S439 G.M. # 11569711	<b>25 Pcs.</b>		
<b>11034PK</b>	#8 (4.20mm) Screw Size 9.00 x 11.00mm Hole Size Black Finish Dash Panel Nuts Ford # N803685S G.M. # 14083173, 17997722, 17988488	<b>25 Pcs.</b>		
<b>15864PK</b>	#8 (4.20-1.41mm) Screw Size 1.40 - 5.00mm Panel Range 10.90 x 13.00mm Hole Size Green Metallic Finish Bracket Retainer Nuts G.M. # 11548673	<b>15 Pcs.</b>		
<b>15691PK</b>	#8 (4.20-1.41mm) Screw Size Zinc Organic Center Console Door, Front Lights, Grille, Lift Gate Nuts With Silicone Pad G.M. # 11610157	<b>10 Pcs.</b>		
<b>10143PK</b>	17/32" (13.50mm) Hole Size 11mm Overall Length Zinc Finish Headlamp Assembly Nuts G.M. # 11570015	<b>15 Pcs.</b>		

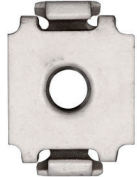

18



# General Motors

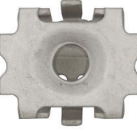

## Nuts Miscellaneous Metric



<b>9597PK</b>	6-1.00mm Screw Size Zinc Organic License Plate Nuts G.M. # 15707256	<b>10 Pcs.</b>		
---------------	--	----------------	--	---

<b>18094PK</b>	6-1.00 Screw Size .70 - 3.80mm Panel Range 9.25 x 13.75mm Hole Size Zinc Finish Rear Bumper Bracket Nuts G.M. # 11547582	<b>25 Pcs.</b>		
----------------	---	----------------	--	---



<b>13423PK</b>	6-1.00 Screw Size 11mm Overall Height Zinc Organic Radiator Grille & Front End Panel Nuts G.M. # 11518937	<b>10 Pcs.</b>		
----------------	--	----------------	--	---

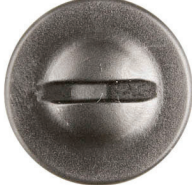

<b>15902PK</b>	6-1.00mm Screw Size 12mm Overall Height Organic Zinc Finish Front Fender Panel Nuts G.M. # 11610544	<b>10 Pcs.</b>		
----------------	---	----------------	--	---

<b>11984PK</b>	5.80mm Stud Size 13mm Hex Size 25mm Washer Diameter Black Nylon Grille Retainer Nuts Use With # 11983 Camaro 2010 Cadillac SRS & SRX G.M. # 11610748	<b>25 Pcs.</b>		
----------------	---	----------------	---	--

<b>11983PK</b>	5.80mm Stem Diameter 25.50mm Stem Length 25mm Head Diameter Black Nylon Slotted Grille Retainers Use With # 11984 Camaro 2010 Cadillac SRS & SRX G.M. # 11610747	<b>25 Pcs.</b>		
----------------	---	----------------	--	---



## Nutserts Hex Type Automotive

<b>12444PK</b>	6-1.00mm Thread Size 8mm Hex Size 12mm Flange Diameter .65 - 2.00mm Grip Range Zinc Finish With Sealer Hex Type Steel Nutserts Ford # N803763-S100 G.M. # 15685099, 11518684	<b>15 Pcs.</b>		
----------------	---	----------------	--	---



<b>12440PK</b>	6-1.00mm Thread Size 9.50mm Hex Size 13mm Flange Diameter .70 - 4.00mm Grip Range Zinc Finish Front Core Support Hex Type Steel Nutserts G.M. # 11519952	<b>15 Pcs.</b>		
----------------	--	----------------	--	---

# General Motors



## Nutserts Hex Type Automotive



<b>12441PK</b>	8-1.25mm Thread Size 12.50mm Hex Size 17mm Flange Diameter .70 - 4.00mm Grip Range Zinc Finish Hex Type Steel Nutserts G.M. # 11519960	<b>15 Pcs.</b>		
----------------	--	----------------	---	---

## Nutserts Round Type

<b>12678PK</b>	6-1.00mm Thread Size .70 - 4.20mm Grip Range 10mm Drill Size Yellow Zinc Knurled Shank Round Type Nutserts G.M. # 10237960	<b>25 Pcs.</b>		
----------------	---	----------------	---	---



## Nutserts Hex Type

<b>12715PK</b>	1/4-20 Thread Size .027 - .165" Grip Range 9/64" Drill Size Yellow Zinc Finish Hex Type Nutserts G.M. # N/A	<b>15 Pcs.</b>		
----------------	--	----------------	---	---

<b>10210PK</b>	5-.80mm Thread Size .50 - 3.30mm Grip Range 7.14mm Drill Size Yellow Zinc Hex Type Nutserts	<b>15 Pcs.</b>		
----------------	---	----------------	---	---

<b>10211PK</b>	6-1.00mm Thread Size .70 - 4.20mm Grip Range 9.53mm Hex Size Yellow Zinc Hex Type Nutserts G.M. # 10281487	<b>15 Pcs.</b>		
----------------	---	----------------	--	--

## Nuts Jack

<b>9371PK</b>	1/4-20 Thread Size 5/8" Stem Length 3/16 - 3/8" Grip Range Raintite Sealer Type Steel Jack Nuts Chrysler # 6031438 G.M. # 367292	<b>25 Pcs.</b>		
---------------	--	----------------	---	---

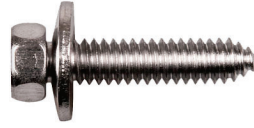



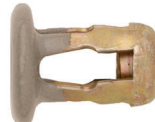



<b>9541PK</b>	1/4-20 x 1" 5/8" Outside Diameter Chrome Finish Outside Mirror Mounting Bolts Use With # 9371 G.M. # 367291, 10001670, 474821	<b>25 Pcs.</b>		
---------------	--	----------------	---	---

<b>1793PK</b>	6-1.00mm Thread Size Roof Rack Mounting Raintite Sealer Type Steel Jack Nuts G.M. # 14007940	<b>10 Pcs.</b>		
---------------	--	----------------	---	---













<b>9561PK</b>	1/4-20 x 1" Screw Size Mirror Mounting Screw & Jack Nut Assembly G.M. # 367292	<b>10 Sets</b>		
---------------	---	----------------	--	---

# General Motors

## Nuts Brass Insert Rubber Well











<b>10035PK</b>	#8-32 Screw Size 5/16" Hole Size 7/16" Stem Length .015 - .178" Grip Range Black Rubber Well Nuts G.M. # 14048060	<b>25 Pcs.</b>		
<b>15953PK</b>	10-24 Screw Size 3/8" Hole Size 37/64" Length .030 - .227" Grip Range Black Rubber With Brass Insert Well Nuts G.M. # 3876130	<b>25 Pcs.</b>		
<b>11284PK</b>	#10-32 Screw Size 3/8" Hole Size 5/8" Stem Length .035 - .232" Grip Range Black Rubber Well Nuts G.M. # 12338025	<b>10 Pcs.</b>		
<b>11899PK</b>	6-1.00mm Screw Size 12.70mm Hole Size 15mm Stem Length 20mm Flange Diameter .015 - .094" Grip Range Roof Rack Mounting Rubber Well Nuts G.M. # 20130258, 14002811	<b>10 Pcs.</b>		

## Rubber Products

<b>13261PK</b>	9/64" (3.60mm) Hole Size 3/4" Stem Length 5/16" Head Diameter Black Rubber General Purpose Bumpers G.M. # 1304225	<b>25 Pcs.</b>		
<b>13262PK</b>	5/32" (3.97mm) Hole Size 27/32" Stem Length 21/64" Head Diameter Black Rubber Glove Box Door Bumpers G.M. # 3693292	<b>25 Pcs.</b>		
<b>13263PK</b>	17/64" (6.75mm) Hole Size 5/16" Stem Length 31/64" Head Diameter Black Rubber License Plate Bumpers G.M. # 3745361, 3762180	<b>25 Pcs.</b>		
<b>9881PK</b>	17/64" (6.75mm) Hole Size 21/64" Stem Length 1/2" Head Diameter Black Rubber Door & Quarter Glass Bumpers G.M. # 4081765	<b>25 Pcs.</b>		
<b>13265PK</b>	17/64" (6.75mm) Hole Size 11/32" Stem Length 5/8" Head Diameter Black Rubber Hood Side Bumpers G.M. # 3688811	<b>25 Pcs.</b>		
<b>13266PK</b>	17/64" (6.75mm) Hole Size 23/64" Stem Length 31/64" Head Diameter Black Rubber Door Bumpers G.M. # 4563173, 4565415	<b>25 Pcs.</b>		



# General Motors

## Rubber Products

<b>13267PK</b>	1/4" (6.35mm) Hole Size 5/8" Stem Length 5/8" Head Diameter Black Rubber General Purpose Bumpers G.M. # 972724	<b>25 Pcs.</b>		
<b>13268PK</b>	9/32" (7.14mm) Hole Size 15/32" Stem Length 23/32" Head Diameter Black Rubber General Purpose Bumpers G.M. # 3664645	<b>25 Pcs.</b>		
<b>13269PK</b>	1/4" (6.35mm) Hole Size 3/8" Stem Length 3/4" Head Diameter Black Rubber General Purpose Bumper G.M. # 3655015	<b>25 Pcs.</b>		
<b>13270PK</b>	27/64" (10.72mm) Hole Size 7/8" Diameter Black Rubber Trunk & Hood Bumpers G.M. # 4137121	<b>25 Pcs.</b>		
<b>16449PK</b>	7/16" (11mm) Slot Size 27mm Overall Height 20mm Overall Width Black Rubber Hood Prop Buffer G.M. # 22755704	<b>25 Pcs.</b>		

18

## Clips Wire Loom Routing

<b>9690PK</b>	1/4" Inside Diameter 3/8" Outside Diameter Black Nylon Wire Loom Routing Clips G.M. # 12015631	<b>15 Pcs.</b>	
<b>1237PK</b>	11/32" Inside Diameter 1/2" Outside Diameter Black Nylon Wire Loom Routing Clips G.M. # 8911473	<b>25 Pcs.</b>	

# General Motors

## Clips Wire Loom Routing

<b>1238PK</b>	13/32" Inside Diameter 19/32" Outside Diameter Black Nylon Wire Loom Routing Clips G.M. # 8911497	25 Pcs.	
<b>1239PK</b>	1/2" Inside Diameter 11/16" Outside Diameter Black Nylon Wire Loom Routing Clips G.M. # 8911472	25 Pcs.	
<b>1240PK</b>	3/4" Inside Diameter 1" Outside Diameter Black Nylon Wire Loom Routing Clips G.M. # 8917320, 3816659	25 Pcs.	



















## Retainers Shield

<b>JL-24PK</b>	7/64" (2.80mm) Hole Size 25/64" Stem Length 7/32" Head Diameter .069 - .250" Panel Range Black Nylon Shield Retainers G.M. # 20729523	100 Pcs.		
<b>5602PK</b>	5/32" (4mm) Hole Size 7/16" Stem Length 23/64" Head Diameter .030 - .275" Panel Range Black Nylon Shield Retainers G.M. # 10063599	100 Pcs.		
<b>8172PK</b>	3/16" (4.50mm) Hole Size 21/32" Stem Length 7/16" Head Diameter .060 - .390" Panel Range Black Nylon Dash Panel Retainers AMC # 4006516 Ford # 388246A G.M. # 25016383, 20413107	50 Pcs.		
<b>9178PK</b>	13/64" (5mm) Hole Size 1/2" Stem Length 7/16" Head Diameter Black Nylon Fascia Shield Retainers Ford # N803170-S G.M. # 16517439	25 Pcs.		
<b>12028PK</b>	13/64" (5mm) Hole Size 14mm Stem Length 9mm Head Diameter Black Nylon Bumper Cover Retainers G.M. # 24205245	50 Pcs.		

18

# General Motors

## Retainers Shield

<b>9528PK</b>	13/64" (5mm) Hole Size 17.80mm Stem Length 11mm Head Diameter Black Nylon Rear Bumper Fascia Retainers G.M. # 1644290 Nissan # 01553-0075U	<b>25 Pcs.</b>		
<b>1583PK</b>	13/64" (5mm) Hole Size 3/4" Stem Length 19/32" Head Diameter .70 - .555" Panel Range Black Nylon Shroud Vent Grille To Panel Retainers G.M. # 20514862	<b>50 Pcs.</b>		
<b>5618PK</b>	15/64" (6mm) Hole Size 1/2" Stem Length 15/32" Head Diameter .035 - .285" Panel Range Black Nylon Shield Retainers G.M. # 20709017	<b>50 Pcs.</b>		
<b>10427PK</b>	15/64" (6mm) Hole Size 13mm Stem Length 9.50mm Head Diameter Black Nylon Body Side Moulding Retainers G.M. # 20455900	<b>25 Pcs.</b>		
<b>11002PK</b>	15/64" (6mm) Hole Size 20mm Stem Length 18mm Head Diameter Black Nylon Bumper & Fender Apron Retainers Ford # W711687-S300 G.M. # 11589181	<b>25 Pcs.</b>		
<b>10568PK</b>	15/64" (6mm) Hole Size 33mm Stem Length 18mm Head Diameter Black Nylon Wheel Well Shield Retainers Ford # W709002, W709002-SAA G.M. # 11588950	<b>25 Pcs.</b>		
<b>1410PK</b>	1/4" (6.30mm) Hole Size 1/2" Stem Length 3/4" Head Diameter Black Nylon Mud Shield Retainers Chrysler # 3861577 Ford # 387258-S G.M. # 20032850	<b>100 Pcs.</b>		
<b>1761PK</b>	1/4" (6.30mm) Hole Size 21/32" Stem Length 11/16" Head Diameter .115 - .400" Panel Range Gray Nylon Shield Retainers Chrysler # 6030538 G.M. # 6270163, 480534	<b>50 Pcs.</b>		
<b>5429PK</b>	1/4" (6.30mm) Hole Size 21/32" Stem Length 11/16" Head Diameter .115 - .400" Panel Range Black Nylon Bumper & Fender Shield Retainers AMC # 4004569 Chrysler # 6031321, 3691590 Ford # 389358-S G.M. # 332364, 14093311, 20732399	<b>100 Pcs.</b>		

18















# General Motors

## Retainers Shield

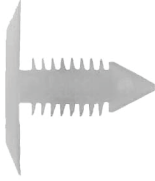
<b>18346PK</b>	1/4" (6.30mm) Hole Size 21/32" Stem Length 11/16" Head Diameter .115 - .400" Panel Range Gray Nylon Shield Retainers Chrysler # 6030538 G.M. # 6270163, 480534	<b>50 Pcs.</b>		
<b>9311PK</b>	1/4" (6.30mm) Hole Size 11/16" Stem Length 1/2" Head Diameter Black Nylon Rear Bumper Fascia Retainers G.M. # 22536642	<b>50 Pcs.</b>		
<b>5506PK</b>	1/4" (6.30mm) Hole Size 23/32" Stem Length 1/2" Head Diameter .110 - .460" Panel Range Black Nylon Trim Panel Retainers G.M. # 411700	<b>50 Pcs.</b>		
<b>5625PK</b>	1/4" (6.30mm) Hole Size 13/16" Stem Length 23/32" Head Diameter .095 - .540" Panel Range Black Nylon Fender & Bumper Shield Retainers AMC # 4004919 Chrysler # 6036007AA, 6502078, 6030441 Ford # 388577S, 389358S, W705589-S300 G.M. # 1605396, 11569768, 15958694	<b>100 Pcs.</b>		
<b>13218PK</b>	1/4" (6.30mm) Hole Size 22mm Stem Length 23mm Head Diameter Tan Nylon Headliner Shield Retainers G.M. # 15944588	<b>25 Pcs.</b>		
<b>9130PK</b>	1/4" (6.30mm) Hole Size 1 1/16" Stem Length 23/32" Head Diameter .095 - .805" Panel Range Black Nylon Engine Splash Shield Retainers Chrysler # 6033082, 6033840 Ford # W709346-S300, 39001S G.M. # 10121502, 10077401	<b>50 Pcs.</b>		
<b>12048PK</b>	1/4" (6.30mm) Hole Size 27mm Stem Length 25.40mm Head Diameter Black Nylon Fender & Headliner Retainers G.M. # 15802005	<b>25 Pcs.</b>		
<b>10366PK</b>	1/4" (6.30mm) Hole Size 1 3/32" Stem Length 7/8" Head Diameter Black Nylon Splash Shield & Wheel Cover Retainers Chrysler # 6501916 G.M. # 22547243	<b>50 Pcs.</b>		

# General Motors

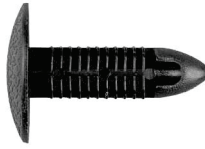
## Retainers Shield

<b>10434PK</b>	1/4" (6.30mm) Hole Size 35mm Stem Length 18mm Head Diameter 10.50 - 26.60mm Panel Range Charcoal Gray Nylon Wheel Opening Moulding Retainers Ford # W705955-S300 G.M. # 10146315	<b>50 Pcs.</b>		
<b>9345PK</b>	1/4" (6.30mm) Hole Size 1 7/16" Stem Length 1" Head Diameter Black Nylon Shield Retainers G.M. # 14027471	<b>25 Pcs.</b>		
<b>16398PK</b>	1/4" (6.50mm) Hole Size 21mm Stem Length 25mm Head Diameter Black Nylon Headliner Retainers G.M. # 13475541	<b>25 Pcs.</b>		
<b>1408PK</b>	9/32" (7mm) Hole Size 9/16" Stem Length 13/32 x 1" Head Size Black Nylon Cowl Insulation Retainers Ford # 384051-S G.M. # 480534	<b>25 Pcs.</b>		
<b>1644PK</b>	9/32" (7mm) Hole Size 3/4" Stem Length 15/16" Head Diameter Natural Nylon Interior Trim Panel Retainers Chrysler # 6003423 G.M. # 2048248, 208824	<b>50 Pcs.</b>		
<b>5635PK</b>	9/32" (7mm) Hole Size 20mm Stem Length 25mm Head Diameter 2.56 - 12.96mm Panel Range Black Nylon Interior Trim Retainers Chrysler # 6506788 Ford # N802734S G.M. # 22718305	<b>50 Pcs.</b>		
<b>12014PK</b>	9/32" (7mm) Hole Size 23mm Stem Length 18mm Head Diameter Black Nylon Inside Fender Shield & Bumper Fascia Retainers G.M. # 94145515 Isuzu # 8941-455150	<b>25 Pcs.</b>		
<b>9374PK</b>	9/32" (7mm) Hole Size 15/16" Stem Length 25/32" Head Diameter Black Nylon Seat Back Shield Retainers G.M. # 20319841	<b>25 Pcs.</b>		













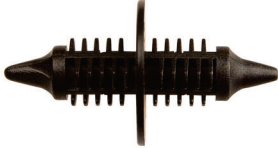

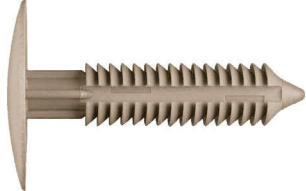
# General Motors

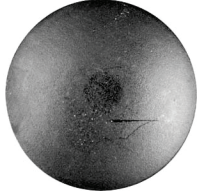
## Retainers Shield

<b>9523PK</b>	9/32" (7mm) Hole Size 1 3/32" Stem Length 1 1/32" Head Diameter Black Nylon Headliner Retainers Ford # W710923-S300 G.M. # 10229437, 10242316	<b>25 Pcs.</b>		
<b>9132PK</b>	9/32" (7mm) Hole Size 1 11/64" Stem Length 3/4" Head Diameter .055 - 1.00" Panel Range Black Nylon Bumper Fascia Retainers Chrysler # 6503768 G.M. # 10185925	<b>25 Pcs.</b>		
<b>11023PK</b>	9/32" (7mm) Hole Size 30mm Stem Length 14mm Head Diameter 2.00 - 21.00mm Panel Range Black Nylon Headlight Trim & Lift Gate Moulding Retainers G.M. # 10185866	<b>25 Pcs.</b>		
<b>9376PK</b>	9/32" (7mm) Hole Size 33.50mm Stem Length 10mm Head Diameter Black Nylon Bumper Cover Retainers G.M.	<b>25 Pcs.</b>		
<b>18827PK</b>	9/32" (7.10mm) Hole Size 21mm Stem Length 25.40mm Head Diameter Light Gray Headliner Retainers G.M. # 23218762	<b>25 Pcs.</b>		
<b>JL-33PK</b>	5/16" (8mm) Hole Size 31/32" Stem Length 3/4" Head Diameter .145 - .530" Panel Range Black Nylon Trim Panel Retainers Chrysler # 6501301 G.M. # 21094146, 21110201	<b>25 Pcs.</b>		
<b>8862BPK</b>	5/16" (8mm) Hole Size 1 1/16" Stem Length 3/4" Head Diameter .090 - .815" Panel Range Black Nylon Shield Retainers G.M. # 15975244	<b>25 Pcs.</b>		
<b>11869PK</b>	5/16" (8mm) Hole Size 1 1/8" Stem Length 1" Head Diameter Gray Nylon Headliner Shield Retainers G.M. # 15006827	<b>25 Pcs.</b>		

# General Motors

## Retainers Shield

<b>12598PK</b>	5/16" (8mm) Hole Size 32mm Stem Length 19mm Head Diameter Black Nylon Pillar Cover Retainers G.M. # 15588078	<b>10 Pcs.</b>		
<b>9195PK</b>	5/16" (8mm) Hole Size 1 7/16" Overall Length 3/4" Outside Diameter Washer Black Nylon Radiator Grille Retainers G.M. # 15672328	<b>25 Pcs.</b>		
<b>11166PK</b>	5/16" (8mm) Hole Size 37mm Stem Length 25mm Head Diameter Tan Nylon Headliner Retainers G.M. # 10444839	<b>25 Pcs.</b>		
<b>10469PK</b>	23/64" (9mm) Hole Size 20mm Stem Length 24mm Head Diameter 1.60 - 10.00mm Panel Range Black Nylon Front End Retainers Chrysler # 6505667-AA Ford # N811540-S, W705681-S300 G.M. # 22189414	<b>25 Pcs.</b>		
<b>5710PK</b>	3/8" (9.50mm) Hole Size 27/32" Stem Length 1" Head Diameter .115 - .565" Panel Range Black Nylon Radiator Apron Panel Retainers G.M. # 1619321	<b>25 Pcs.</b>		
<b>9352PK</b>	3/8" (9.50mm) Hole Size 57/64" Stem Length 7/8" Head Diameter Black Nylon Front End Stone Shield Retainers Chrysler # 6503221 G.M. # 22512276	<b>25 Pcs.</b>		
<b>5648PK</b>	25/64" (10mm) Hole Size 30mm Stem Length 22mm Head Diameter 1.19 - 20.20mm Panel Range Black Nylon Fascia Bumper Retainers Chrysler # 34202787 Ford # N804379-S G.M. # 1631564	<b>50 Pcs.</b>		
<b>10672PK</b>	13/32" (10.50mm) Hole Size 28mm Stem Length 21.50mm Head Diameter Black Nylon Bumper Fascia Retainers G.M. # 11518201	<b>15 Pcs.</b>		

18

# General Motors

## Retainers Shield

**9493PK** 13/32" (10.50mm) Hole Size  
1 7/16" Stem Length  
1" Head Diameter  
Black Nylon  
Firewall Insulation Retainers  
AMC # 4001934  
G.M. # 7642589

25 Pcs.

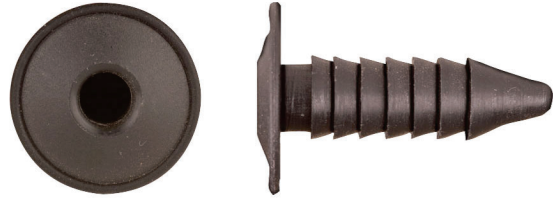

**9763PK** 1/2" (12.50mm) Hole Size  
15mm Stem Length  
25mm Head Diameter  
3.20 - 5.00mm Panel Range  
Black Nylon  
Bumper Fascia Retainers  
Chrysler # 65058686AA  
G.M. # 15056810

25 Pcs.



## Retainers Trim Panel

**16392PK** 8.25 x 17.50mm Slot Size  
8.60mm Stem Length  
16.00 x 22.00mm Head Size  
White Nylon  
Trim Retainers  
G.M. # 11603036

25 Pcs.



**16062PK** 9mm Stem Length  
12.00 x 22.00mm Top Head Size  
Black Nylon  
Headliner Retainers  
G.M. # 11547523, 11601777

15 Pcs.



## Clips Hood Rod Prop

**10084PK** 7mm Rod Size  
10mm Hole Size  
Natural Nylon  
Hood Prop Rod Clips  
Chrysler # 5027550AB  
G.M. # 15021761

25 Pcs.



**10082PK** 5/16" Rod Size  
Natural Nylon  
Hood Prop Rod Clips  
G.M. # 21097292

15 Pcs.



## Retainers Hood Seal

**1996PK** 13/64" (5mm) Hole Size  
11mm Stem Length  
13mm Head Diameter  
Black Nylon  
Hood Seal Retaining Clips  
G.M. # 94842841, 94849113  
Toyota # 90467-08004, 90467-08011

50 Pcs.



**9520PK** 5/16" (8mm) Hole Size  
21/32" Stem Length  
5/8" Head Diameter  
Black Nylon  
Hood Seal Retainers  
G.M. # 22567463

25 Pcs.



# General Motors

## Retainers Hood Seal

**5995PK**

5/16" (8mm) Hole Size  
1 7/16" Stem Length  
3/4" Head Diameter  
.055 - 1.05" Panel Range  
Black Nylon  
Hood Seal Retainers  
G.M. # 14074081, 15552345, 1699250

25 Pcs.

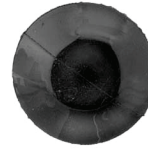

## Retainers Hood Insulation

**2167PK**

1/4" (6.30mm) Hole Size  
12.50mm Stem Length  
30mm Head Diameter  
Black Nylon  
Hood Insulation Retainers  
Chrysler # 6502842  
G.M. # 21039129

50 Pcs.



**1930PK**

1/4" (6.30mm) Hole Size  
3/4" Stem Length  
1 5/8" Head Diameter  
Black Nylon  
Hood Insulation Clips  
G.M. # 20064875

25 Pcs.



**5440PK**

1/4" (6.30mm) Hole Size  
3/4" Stem Length  
2" Head Diameter  
Black Nylon  
Hood Insulation Retainers  
G.M. # 3078511, 3977775

25 Pcs.

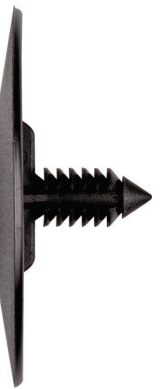
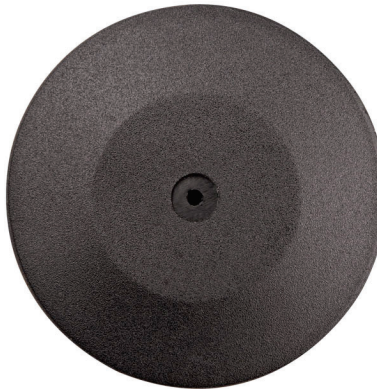

**10393PK**

9/32" (7mm) Hole Size  
13mm Stem Length  
40mm Head Diameter  
Black Nylon  
Hood Insulation Retainers  
G.M. # 21039141, 15678493

25 Pcs.

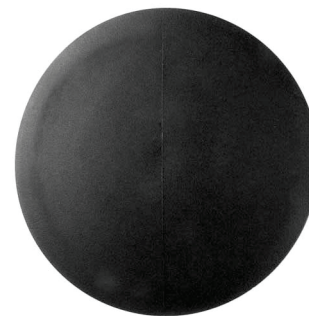

18

# General Motors

## Retainers Hood Insulation

**12172PK**

9/32" (7mm) Hole Size  
15mm Stem Length  
30mm Head Diameter  
Black Nylon  
Hood Insulation Retainers  
G.M. # 11571159

**25 Pcs.**



**1929PK**

9/32" (7mm) Hole Size  
25mm Stem Length  
35mm Head Diameter  
Black Polypropylene  
Hood Insulation Retainers  
G.M. # 20030401

**25 Pcs.**



**12072PK**

9/32" (7.10mm) Hole Size  
17mm Stem Length  
28mm Head Diameter  
Black Nylon  
Hood Insulation Retainers  
G.M. # 15989431

**25 Pcs.**



**15696PK**

5/16" (8mm) Hole Size  
16mm Stem Length  
32mm Head Diameter  
Black Nylon  
Hood Insulation Retainers  
G.M. # 11611677

**10 Pcs.**

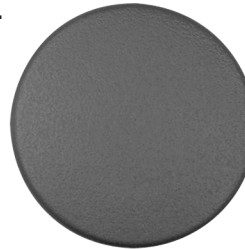

## Retainers Weatherstrip

**9863PK**

1/8" (3.30mm) Hole Size  
13/32" Stem Length  
3/8" Head Diameter  
Black Nylon  
Weatherstrip Retainers  
G.M. # 8731909, 4841194

**100 Pcs.**



**18247PK**

9/64" (3.50mm) Hole Size  
7/16" Stem Length  
13/32" Flange Diameter  
Black Nylon  
Weatherstrip Retainers  
G.M. # 4801268

**100 Pcs.**



**10657PK**

11/64" (4.20mm) Hole Size  
12mm Stem Length  
11mm Head Diameter  
Black Nylon  
Weatherstrip Retainers  
Chrysler # 6104908-AA  
G.M. # 20538173  
Mercedes # 002-997-33-86



















**50 Pcs.**

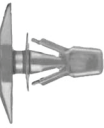

18



# General Motors



## Retainers Weatherstrip

<b>1991PK</b>	11/64" (4.50mm) Hole Size 12mm Stem Length 4.75 x 13.50mm Head Size Black Nylon Weatherstrip Retainers G.M. # 4876498	<b>100 Pcs.</b>		
<b>5605PK</b>	3/16" (4.80mm) Hole Size 21/64" Stem Length 7/16" Head Diameter .080 - .200" Panel Range Black Nylon Weatherstrip Retainers G.M. # 10169777	<b>25 Pcs.</b>		
<b>JL-32PK</b>	3/16" (4.80mm) Hole Size 17/32" Stem Length 3/8" Head Diameter .125 - .310" Panel Range Black Nylon Weatherstrip Retainers G.M. # 2964547	<b>25 Pcs.</b>		
<b>16451PK</b>	13/64" (5mm) Hole Size 8mm Stem Length 6.50 x 14.00mm Head Size Natural Nylon Weatherstrip Retainers G.M. # 11611342	<b>100 Pcs.</b>		
<b>16448PK</b>	13/64" (5mm) Hole Size 4.70 x 7.00mm Stem Size 6.50 x 14.00mm Top Head Size Green Nylon Door Weatherstrip Retainers G.M. # 11611664	<b>25 Pcs.</b>		
<b>2016PK</b>	13/64" (5mm) Hole Size 10.50mm Stem Length 6.50 x 16.50mm Head Size White Nylon Weatherstrip Retainers Chrysler # 4696129 G.M. # 21077575	<b>50 Pcs.</b>		
<b>10664PK</b>	13/64" (5mm) Hole Size 10.50mm Stem Length 10.90mm Top Head Diameter Natural Nylon Weatherstrip Retainers G.M.	<b>50 Pcs.</b>		
<b>JL-23PK</b>	13/64" (5mm) Hole Size 11.50mm Stem Length 10mm Head Diameter .030 - .285" Panel Range Black Nylon Weatherstrip Retainers G.M. # 20699808	<b>50 Pcs.</b>		
<b>5609PK</b>	13/64" (5mm) Hole Size 5/8" Stem Length 19/32" Head Diameter .030 - .365" Panel Range Black Nylon Weatherstrip Retainers Chrysler # 4658673 G.M. # 10293674	<b>50 Pcs.</b>		
<b>10974PK</b>	13/64" (5mm) Hole Size 9mm Stem Length 5.00 x 15.00mm Head Size Natural Nylon Weatherstrip Retainers G.M. # 10283414, 10405030	<b>100 Pcs.</b>		



# General Motors



## Retainers Weatherstrip



<b>10462PK</b>	15/64" (6mm) Hole Size 15.50mm Stem Length 12.60mm Head Diameter .80 - 8.00mm Panel Range Black Nylon Weatherstrip Retainers Ford # N811040-S G.M. # 10293193	<b>50 Pcs.</b>		
----------------	--	----------------	--	---



<b>11906PK</b>	9/32" (7.10mm) Hole Size 5/8" Stem Length 1/2" Head Diameter Black Nylon Weatherstrip Retainers G.M. # 390126-S	<b>25 Pcs.</b>		
----------------	--	----------------	--	---



## Retainers Push Type



<b>10425PK</b>	13/64" (5mm) Hole Size 10mm Stem Length 7mm Flange Diameter Black Nylon Door Handle Attachment Push Type Retainers G.M. # 21077405	<b>25 Pcs.</b>		
----------------	--	----------------	--	---

<b>9859PK</b>	13/64" (5mm) Hole Size 10mm Stem Length 7mm Flange Diameter Black Nylon Door Handle Push Type Retainers G.M. # 21097229	<b>25 Pcs.</b>		
---------------	---	----------------	--	---

<b>1310PK</b>	13/64" (5mm) Hole Size 15/32" Stem Length 3/8" Head Diameter Black Nylon Tail Light Push Type Retainers Chrysler # 6500787 G.M. # 16500308	<b>25 Pcs.</b>		
---------------	---	----------------	---	--













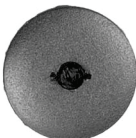

<b>16084PK</b>	7/32" (5.60mm) Hole Size 12.70mm Stem Length 9.50mm Head Size Black Nylon Body Side Moulding Push Type Retainers G.M. # 20363491	<b>25 Pcs.</b>		
----------------	--	----------------	--	---

<b>9947PK</b>	15/64" (6mm) Hole Size 14mm Stem Length 14mm Head Diameter Black Nylon Push Type Retainers G.M. # 21047094, 21110145	<b>25 Pcs.</b>		
---------------	---	----------------	--	---

<b>9617PK</b>	15/64" (6mm) Hole Size 16mm Stem Length 17mm Flange Diameter Black Nylon Radiator & Fender Push Type Retainers Chrysler # 6506008-AA Ford # W709176-S300 G.M. # 15149708	<b>25 Pcs.</b>		
---------------	--	----------------	--	---

# General Motors

















## Retainers Push Type

<b>9320PK</b>	15/64" (6mm) Hole Size 23mm Stem Length 15mm Flange Diameter Black Nylon Push Type Fascia Retainers Chrysler # 4857108 Ford # N803709S G.M. # 15681408, 25642453	<b>50 Pcs.</b>		
<b>17598PK</b>	1/4" (6.30mm) Hole Size 13mm Stem Length 15mm Flange Diameter Black Nylon Push Type Retainers G.M. # 96057846 Hyundai # 86155-2200 Toyota # 90467-07041, 90467-07041-B2, 90467-07076-C0	<b>10 Pcs.</b>		
<b>5675PK</b>	1/4" (6.30mm) Hole Size 9/16" Stem Length 11/16" Flange Diameter Black Nylon Front Fender Mud Skirt & Liner Push Type Retainer AMC # 8934-201-621 AMC/Jeep # 6503454 Chrysler # 34201621, 6504090 Ford # E308-4A163CA G.M. # 14019205, 14019206	<b>50 Pcs.</b>		
<b>1087PK</b>	1/4" (6.30mm) Hole Size 5/8" Stem Length 11/16" Flange Diameter Black Nylon Push Type Retainers Chrysler # 6031390 G.M. # 472434	<b>50 Pcs.</b>		
<b>9559PK</b>	1/4" (6.30mm) Hole Size 3/4" Stem Length 19/32" Flange Diameter Black Nylon Wheel Moulding Push Type Retainers Chrysler # 6509103AA, 6509103-AA Ford # W705436-S300 G.M. # 21077123, 20730531	<b>25 Pcs.</b>		
<b>2045PK</b>	1/4" (6.30mm) Hole Size 13/16" Stem Length 11/16" Flange Diameter Black Nylon Push Type Retainers Chrysler # 6501925 Ford # F50C-9E728-AA G.M. # 10134407, 15990756	<b>25 Pcs.</b>		
<b>18221PK</b>	1/4" (6.30mm) Hole Size 7/8" Stem Length 11/16" Flange Diameter Black Nylon Body Push Type Retainers Chrysler # 34202672 Ford # N803362-S G.M. # 20510029	<b>25 Pcs.</b>		

18

















# General Motors

## Retainers Push Type

<b>5935PK</b>	1/4" (6.30mm) Hole Size 7/8" Stem Length 1" Flange Diameter Black Nylon Splash Shield Push Type Retainers Chrysler # 55176248 Ford # 802781-S, W704340-S300, N802781-S G.M. # 14093088	<b>25 Pcs.</b>		
<b>9745PK</b>	1/4" (6.30mm) Hole Size 1 1/8" Stem Length 3/4" Flange Diameter Black Nylon Push Type Retainers G.M. # 3540858	<b>25 Pcs.</b>		
<b>10368PK</b>	1/4" (6.50mm) Hole Size 17.50mm Stem Length 18mm Flange Diameter 2.00 - 4.50mm Panel Range Black Nylon Push Type Retainers Chrysler # 6508863AA Ford # W713610-S300 G.M. # 11589289	<b>25 Pcs.</b>		
<b>10369PK</b>	1/4" (6.50mm) Hole Size 20mm Stem Length 18mm Flange Diameter 4.50 - 7.00mm Panel Range Black Nylon Push Type Retainers Chrysler # 6509049-AA Ford # W714040-S300 G.M. # 11589290	<b>50 Pcs.</b>		
<b>10367PK</b>	1/4" (6.50mm) Hole Size 22mm Stem Length 18mm Flange Diameter 7.00 - 9.50mm Panel Range Black Nylon Push Type Retainers Ford # W713331-S300 G.M. # 11589291	<b>25 Pcs.</b>		
<b>12283PK</b>	1/4" (6.50mm) Hole Size 22mm Stem Length 18mm Flange Diameter Black Nylon With Sealer Cowl Vent Retainers G.M. # 95230842	<b>15 Pcs.</b>		
<b>10450PK</b>	9/32" (7mm) Hole Size 7.50mm Stem Length 18mm Flange Diameter Black Nylon Front Fender Liner Push Type Retainers G.M. # 88970767 Toyota # 90467-10183	<b>10 Pcs.</b>		
<b>18789PK</b>	9/32" (7mm) Hole Size 9mm Stem Length 14mm Head Diameter Black Nylon Push Type Retainers Ford # N807673-S G.M. # 25612368	<b>10 Pcs.</b>		



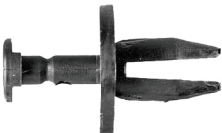
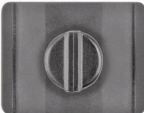







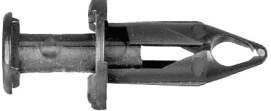

# General Motors

## Retainers Push Type

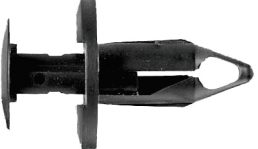
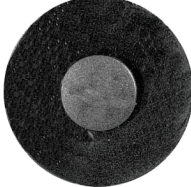
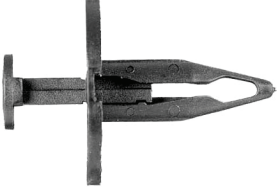
<b>14996PK</b>	9/32" (7mm) Hole Size 12mm Stem Length 16mm Head Diameter Black Nylon Liftgate & Garnish Moulding Push Type Retainers G.M. # 21035345	<b>15 Pcs.</b>		
<b>10410PK</b>	9/32" (7mm) Hole Size 14mm Stem Length 11mm Flange Diameter Black Nylon Radiator Grille Retainers G.M. # 96057847, 94847334 Suzuki # 09409-07313, 90467-07313 Toyota # 90467-07066, 90467-07066-J0	<b>10 Pcs.</b>		
<b>13094PK</b>	9/32" (7mm) Hole Size 14mm Stem Length 21mm Flange Diameter Black Nylon Headliner Push Type Retainers G.M. # 11547047	<b>25 Pcs.</b>		
<b>9369PK</b>	9/32" (7.10mm) Hole Size 7/8" Stem Length 11/16" Flange Diameter Black Nylon Exterior Body Push Type Retainers G.M. # 20590899	<b>25 Pcs.</b>		
<b>10660PK</b>	5/16" (8mm) Hole Size 9.30mm Stem Length 16mm Head Diameter Black Nylon Weatherstrip Retainers G.M.	<b>50 Pcs.</b>		
<b>10421PK</b>	5/16" (8mm) Hole Size 10mm Stem Length 15mm Head Diameter Natural Nylon With Sealer Radiator Grille Retainers G.M. # 94848834 Toyota # 62955-20020, 62955-12010	<b>25 Pcs.</b>		
<b>18167PK</b>	5/16" (8mm) Hole Size 15mm Stem Length 20mm Head Diameter Black Nylon Front Fender Retainers G.M. # 11546805	<b>50 Pcs.</b>		
<b>5676PK</b>	5/16" (8mm) Hole Size 13.50mm Stem Length 17mm Flange Diameter Black Nylon Radiator Push Type Retainers Chrysler # 175720B010 Ford # 04388293 G.M. # 14071289, 14019226	<b>25 Pcs.</b>		
<b>12724PK</b>	5/16" (8mm) Hole Size 15mm Stem Length 15.00 x 19.00mm Flange Black Nylon Grille Attachment Retainers G.M. # 14032200	<b>25 Pcs.</b>		

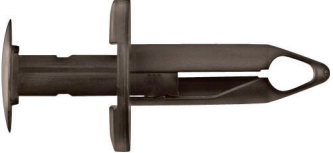



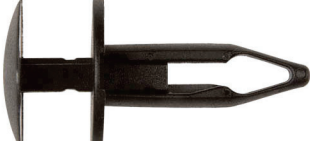







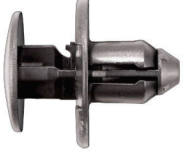

# General Motors

## Retainers Push Type

<b>15359PK</b>	5/16" (8mm) Hole Size 19/32" Stem Length 21/32" Flange Diameter Black Nylon Push Type Retainer G.M. # 14039420	<b>25 Pcs.</b>		
<b>10370PK</b>	5/16" (8mm) Hole Size 16mm Stem Length 19mm Flange Diameter 5.00 - 7.00mm Panel Range Black Nylon Push Type Retainers Chrysler # 5116530AA G.M. # 15296830	<b>25 Pcs.</b>		
<b>1861PK</b>	5/16" (8mm) Hole Size 20mm Stem Length 15mm Flange Diameter Black Nylon Rocker Panel Retainers Chrysler # 6504555 Ford # F3LB-14K056-AA G.M. # 21075686	<b>25 Pcs.</b>		
<b>1860PK</b>	5/16" (8mm) Hole Size 20mm Stem Length 20mm Flange Diameter Black Nylon Air Baffle Push Type Retainers Chrysler # 6503598 Ford # N807389S, 807389S G.M. # 21030249, 15969147	<b>25 Pcs.</b>		
<b>5940PK</b>	5/16" (8mm) Hole Size 7/8" Stem Length 1" Flange Diameter Black Nylon Splash Shield Push Type Retainers Ford # N804614S, N803934-S G.M. # 20570245, 20635065	<b>25 Pcs.</b>		
<b>10504PK</b>	5/16" (8mm) Hole Size 26mm Stem Length 20mm Flange Diameter Black Nylon Fender Shield Push Type Retainers Ford # W708530-S300 G.M. # 11518017	<b>15 Pcs.</b>		
<b>10669PK</b>	5/16" (8mm) Hole Size 27mm Stem Length 16.50mm Flange Diameter Black Nylon Rear Wheel Apron & Bumper Push Type Retainers Chrysler # 04596357AA G.M. # 15994165	<b>25 Pcs.</b>		
<b>9357PK</b>	5/16" (8mm) Hole Size 28mm Stem Length 20mm Flange Diameter Black Nylon Bumper Fascia Retainers G.M. # 21095797	<b>25 Pcs.</b>		

# General Motors











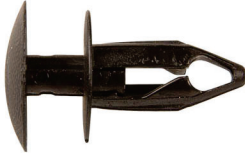

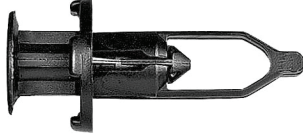

## Retainers Push Type

<b>9184PK</b>	5/16" (8mm) Hole Size 29mm Stem Length 15mm Head Diameter Black Nylon Rocker Moulding Push Type Retainers G.M. # 10207146, 21077323	<b>25 Pcs.</b>		
<b>10673PK</b>	5/16" (8mm) Hole Size 30mm Stem Length 25mm Flange Diameter Black Nylon Bumper Cover Retainers G.M. # 11561874 Nissan # 622A2-9E000A, 622A2-9E000	<b>10 Pcs.</b>		
<b>10239PK</b>	21/64" (8.30mm) Hole Size 14mm Stem Length 19mm Flange Diameter 2.70 - 5.30mm Panel Range Black Nylon Push Type Retainers Ford # W715537-S300 G.M. # 11609417	<b>50 Pcs.</b>		
<b>13089PK</b>	21/64" (8.50mm) Hole Size 12mm Stem Length 20mm Flange Diameter Black Nylon Front Fender & Body Side Liner Push Type Retainers G.M. # 11612035	<b>25 Pcs.</b>		
<b>10371PK</b>	21/64" (8.50mm) Hole Size 20.50mm Stem Length 20mm Flange Diameter 2.00 - 4.50mm Panel Range Black Nylon Push Type Retainers G.M. # 11589292	<b>25 Pcs.</b>		
<b>10374PK</b>	21/64" (8.50mm) Hole Size 22mm Stem Length 20mm Flange Diameter 4.50 - 7.00mm Panel Range Black Nylon Push Type Retainers Ford # W712196S300 G.M. # 11589293	<b>25 Pcs.</b>		
<b>10372PK</b>	21/64" (8.50mm) Hole Size 24mm Stem Length 20mm Flange Diameter 7.00 - 10.00mm Panel Range Black Nylon Push Type Retainers G.M. # 11589294	<b>25 Pcs.</b>		
<b>13234PK</b>	23/64" (9mm) Hole Size 13mm Stem Length 24.50mm Flange Diameter Black Nylon Sight Shield & Trim Push Type Retainers G.M. # 10382313	<b>10 Pcs.</b>		

18



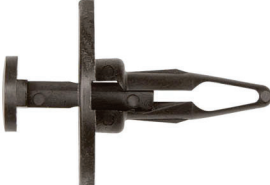







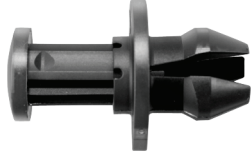

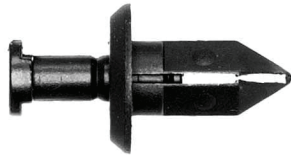

# General Motors

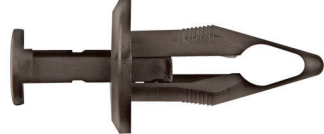
## Retainers Push Type

<b>10247PK</b>	23/64" (9mm) Hole Size 21mm Stem Length 20mm Flange Diameter Black Nylon Rear Bumper Cover Push Type Retainers G.M. # 15153415	<b>25 Pcs.</b>		
<b>9327PK</b>	23/64" (9mm) Hole Size 28mm Stem Length 18mm Flange Diameter Black Nylon Rear Bumper Cover Push Type Retainers G.M. # 94858560 Toyota # 52161-16010, 52161-02020, 52161-02030	<b>4 Pcs.</b>		
<b>5677PK</b>	3/8" (9.50mm) Hole Size 11/16" Stem Length 1" Flange Diameter Black Nylon Fascia Blind Rivets Chrysler # 55074801 G.M. # 14045480	<b>25 Pcs.</b>		
<b>9935PK</b>	3/8" (9.50mm) Hole Size 18mm Stem Length 17mm Flange Diameter Black Nylon Front Bumper Fascia Push Type Retainers G.M. # 1636632, 20687704	<b>25 Pcs.</b>		
<b>10375PK</b>	3/8" (9.50mm) Hole Size 20mm Stem Length 18mm Flange Diameter 3.00 - 5.80mm Panel Range Black Nylon Push Type Retainers Chrysler # 6508712AA G.M. # 11561368	<b>25 Pcs.</b>		
<b>9370PK</b>	3/8" (9.50mm) Hole Size 23mm Stem Length 18mm Flange Diameter Black Nylon Front Bumper Fascia Retainers G.M. # 15993201, 10157900, 11517803	<b>25 Pcs.</b>		
<b>10674PK</b>	3/8" (9.50mm) Hole Size 15/16" Stem Length 1" Flange Diameter 5/32" Shoulder Length Black Nylon Rear Bumper Fascia Retainers G.M. # 22587036	<b>25 Pcs.</b>		
<b>11165PK</b>	25/64" (10mm) Hole Size 12mm Stem Length 26mm Flange Diameter Black Nylon Fuel Tank Shield Push Type Retainers G.M. # 22718369	<b>25 Pcs.</b>		

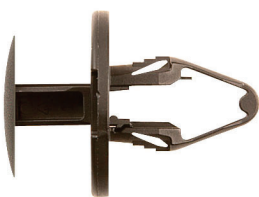
# General Motors

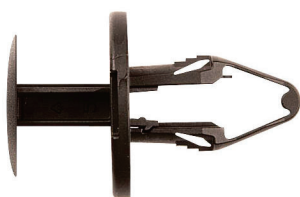
## Retainers Push Type

<b>9687PK</b>	25/64" (10mm) Hole Size 13.50mm Stem Length 20mm Flange Diameter Black Nylon Radiator Grille Push Type Retainers Chrysler # 6509761-AA G.M. # 24512415	<b>15 Pcs.</b>		
<b>15003PK</b>	25/64" (10mm) Hole Size 18mm Stem Length 27mm Flange Diameter Black Nylon Radiator Support Push Type Retainers G.M. # 25695687	<b>15 Pcs.</b>		
<b>2026PK</b>	25/64" (10mm) Hole Size 20mm Stem Length 20mm Flange Diameter Black Nylon Front Bumper Fascia Retainers G.M. # 10108746	<b>25 Pcs.</b>		
<b>10502PK</b>	25/64" (10mm) Hole Size 26mm Stem Length 18mm Flange Diameter Black Nylon Bumper Cover Push Type Retainers G.M. # 11519444, 11517803, 4857753AA	<b>25 Pcs.</b>		
<b>11257PK</b>	25/64" (10mm) Hole Size 36mm Stem Length 24.50mm Top Flange Diameter Natural Nylon Front Bumper Deflector Retainers G.M. # 10426555	<b>15 Pcs.</b>		
<b>10377PK</b>	13/32" (10.50mm) Hole Size 20mm Stem Length 25mm Flange Diameter 3.00 - 6mm Panel Range Black Nylon Push Type Retainers Chrysler # 5GUU9K11BA Ford # W712665-S300 G.M. # 11589295	<b>15 Pcs.</b>		
<b>10378PK</b>	13/32" (10.50mm) Hole Size 23mm Stem Length 25mm Flange Diameter 6.00 - 9.00mm Panel Range Black Nylon Push Type Retainers G.M. # 11589296	<b>15 Pcs.</b>		
<b>9592PK</b>	7/16" (11mm) Hole Size 2" Stem Length 1 3/16" Flange Diameter Black Nylon Fascia Push Type Retainers G.M. # 214077131 Nissan # 01553-0161U	<b>10 Pcs.</b>		

# General Motors

## Retainers Push Type

<b>5672PK</b>	<p>1/2" (12.70mm) Hole Size          3/4" Stem Length          1" Flange Diameter          1/8" Shoulder Length          Black Nylon Fascia          Push Type Retainers          G.M. # 5973400</p>	<b>25 Pcs.</b>		
<b>1234PK</b>	<p>1/2" (12.70mm) Hole Size          25/32" Stem Length          7/8" Flange Diameter          5/32" Shoulder Length          Blue Nylon Fascia          Push Type Retainers          G.M. # 5973823</p>	<b>25 Pcs.</b>		
<b>10714PK</b>	<p>1/2" (12.70mm) Hole Size          15/16" Stem Length          1" Flange Diameter          7/64" Shoulder Length          Black Nylon          Plastic Cover On Engine          Push Type Retainers          G.M. # 14101262</p>	<b>25 Pcs.</b>		
<b>11112PK</b>	<p>1/2" (12.70mm) Hole Size          15/16" Stem Length          1 1/8 x 1 3/4" Flange Size          Black Nylon          Front Bumper Fascia          Push Type Retainers          G.M. # 22659122</p>	<b>10 Pcs.</b>		
<b>5680PK</b>	<p>1/2" (12.70mm) Hole Size          1" Stem Length          1" Flange Diameter          3mm Shoulder Length          Black Nylon Fascia          Push Type Retainers          G.M. # 22535007</p>	<b>25 Pcs.</b>		
<b>1448PK</b>	<p>1/2" (12.70mm) Hole Size          1 3/64" Stem Length          7/8" Flange Diameter          3/16" Shoulder Length          Black Nylon          Bumper Fascia Retainers          G.M. # 14103461</p>	<b>25 Pcs.</b>		
<b>1447PK</b>	<p>1/2" (12.70mm) Hole Size          1 1/8" Stem Length          1" Flange Diameter          1/4" Shoulder Length          Black Nylon Bumper Fascia          Push Type Retainers          Chrysler # 55022134          G.M. # 10077283, 14103438</p>	<b>25 Pcs.</b>		

# General Motors

## Retainers Push Type

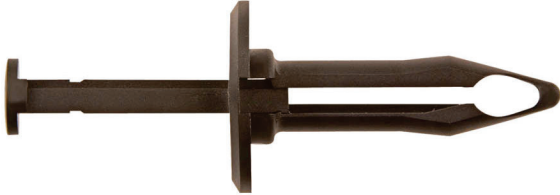
<b>10382PK</b>	1/2" (12.70mm) Hole Size 1 5/8" Stem Length 1" Flange Diameter 9/64" Shoulder Length Black Nylon License Plate Push Type Retainers G.M. # 15959832	<b>5 Pcs.</b>	
----------------	--	---------------	--

<b>15029PK</b>	1/2" (12.70mm) Hole Size 44.50mm Stem Length 25.40mm Flange Diameter Gray Nylon Front License Bracket Push Type Retainers G.M. # 15959833	<b>5 Pcs.</b>	
----------------	--	---------------	---

<b>10535PK</b>	19/32" (15mm) Hole Size 13mm Stem Length 22mm Flange Diameter Black Nylon Rocker Moulding Push Type Retainers G.M. # 5480772	<b>10 Pcs.</b>	
----------------	---	----------------	--

<b>9695PK</b>	13mm Stem Length 28mm Flange Diameter Black Nylon Front Air Deflector Grommets Use With # 9694 G.M. # 15733970	<b>25 Pcs.</b>	
---------------	---	----------------	---

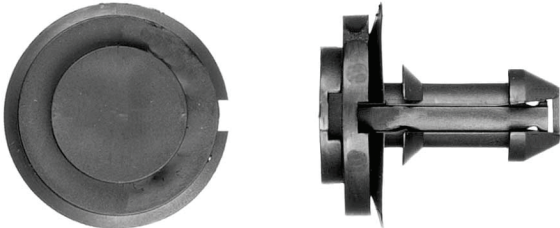
<b>9694PK</b>	24mm Stem Length 30mm Flange Diameter Black Nylon Front Air Deflector Retainers Use With # 9695 G.M. # 15733971	<b>15 Pcs.</b>	
---------------	--	----------------	--

## Retainers Phillips Screw

















<b>1597PK</b>	15/64" (6mm) Hole Size 11mm Stem Length 15mm Flange Diameter Black Nylon Phillips Screw Retainers G.M. # 30012018 Honda # 90684-SA5-0030, 90684-SA5-003 Isuzu # 874-298-1190, 8942981190 Nissan # 10998-30880	<b>25 Pcs.</b>	
---------------	---	----------------	---

<b>2028PK</b>	15/64" (6mm) Hole Size 16mm Stem Length 14mm Flange Diameter Black Nylon Engine Splash Phillips Screw Retainers G.M. # 94051993 Nissan # 66860-01W01	<b>25 Pcs.</b>	
---------------	---	----------------	---

18











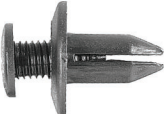

# General Motors

## Retainers Phillips Screw

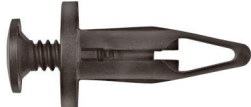
<b>11910PK</b>	15/64" (6mm) Hole Size 17mm Stem Length 12mm Head Diameter Black Nylon Fender & Rocker Phillips Screw Retainer G.M. # 255657634	<b>25 Pcs.</b>		
<b>9783PK</b>	15/64" (6mm) Hole Size 20mm Stem Length 11mm Flange Diameter Black Nylon Rocker Panel Phillips Screw Retainers G.M. # 10246149, 22657634	<b>25 Pcs.</b>		
<b>12472PK</b>	1/4" (6.30mm) Hole Size 14mm Stem Length 15mm Flange Diameter Black Nylon Fender Liner Phillips Screw Retainers G.M. # 94530438 Ford # B04068865A96	<b>25 Pcs.</b>		
<b>9508PK</b>	1/4" (6.30mm) Hole Size 11/16" Stem Length 11/16" Flange Size Black Nylon Phillips Screw Retainers Ford # N808147S G.M. # 10139822, 25680782	<b>25 Pcs.</b>		
<b>9968PK</b>	1/4" (6.30mm) Hole Size 29/32" Stem Length 5/8" Flange Diameter Black Nylon Phillips Screw Retainers G.M. # 20664091 Ford # N803946S Chrysler # 6502871 Mercedes # 000-9941-52-40	<b>50 Pcs.</b>		
<b>9067PK</b>	1/4" (6.30mm) Hole Size 29/32" Stem Length 11/16" Flange Diameter Black Nylon Radiator Shroud Phillips Screw Retainers Chrysler # 6502790, 4638136 Ford # N804570S G.M. # 15773445, 20452072, 22538004, 20664092	<b>25 Pcs.</b>		
<b>1612PK</b>	9/32" (7mm) Hole Size 9mm Stem Length 14.00 x 22.00mm Flange Size Black Nylon Phillips Screw Retainers G.M. # 94221150 Isuzu # 8942211500 Nissan # 63844-D0100	<b>25 Pcs.</b>		
<b>10716PK</b>	9/32" (7mm) Hole Size 9mm Stem Length 20mm Flange Diameter Black Nylon Garnish Moulding Phillips Screw Retainers G.M. # 88970494, 88973676 Toyota # 90467-07168, 90467-07168-C1	<b>15 Pcs.</b>		

# General Motors

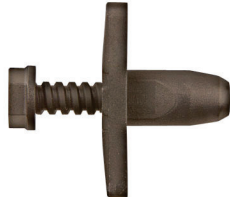
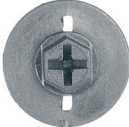
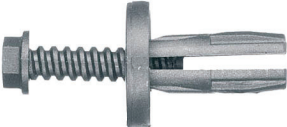
## Retainers Phillips Screw

<b>10413PK</b>	9/32" (7mm) Hole Size 9mm Stem Length 20mm Flange Diameter Black Nylon Quarter Panel Phillips Screw Retainers G.M. # 96064506 Suzuki # 09409-07303-5ES Toyota # 90467-07044	<b>10 Pcs.</b>		
<b>2015PK</b>	9/32" (7mm) Hole Size 11mm Stem Length 14mm Flange Diameter Black Nylon Phillips Screw Retainers G.M. # 94198687 Honda # 90657-SA6-0030, 90657-SA6-003 Mazda # N304-13-356-A	<b>25 Pcs.</b>		
<b>1603PK</b>	9/32" (7mm) Hole Size 12mm Stem Length 15mm Flange Diameter Black Nylon Phillips Screw Retainers G.M. # 20426301 Mazda # 9926-50-625 Toyota # 90467-06017, 90467-06017-20, 90467-06017-41, 90467-06017-C0	<b>15 Pcs.</b>		
<b>10614PK</b>	9/32" (7mm) Hole Size 23mm Stem Length 14mm Flange Diameter Black Nylon Phillips Screw Retainers G.M. # 15014352	<b>15 Pcs.</b>		
<b>11918PK</b>	9/32" (7mm) Hole Size 1 13/64" Stem Length 1/2" Head Diameter Black Nylon Push Type Retainers Chrysler # 4696488 Ford # N805026S G.M. # 10195515	<b>25 Pcs.</b>		
<b>10523PK</b>	5/16" (8mm) Hole Size 14mm Stem Length 14.00 x 26.00mm Flange Size Black Nylon Front Bumper Phillips Screw Retainers G.M. # 12337831	<b>50 Pcs.</b>		
<b>1265PK</b>	5/16" (8mm) Hole Size 18mm Stem Length 17mm Flange Diameter Black Nylon Phillips Screw Retainers G.M. # 20451119 Nissan # 63844-01A99	<b>25 Pcs.</b>		
<b>1446PK</b>	5/16" (8mm) Hole Size 13/16" Stem Length 19/32 Flange Diameter Black Nylon Phillips Screw Retainers Chrysler # 6503163 G.M. # 10053182	<b>25 Pcs.</b>		

18

# General Motors

## Retainers Phillips Screw

**2163PK** 5/16" (8mm) Hole Size  
21mm Stem Length  
20mm Flange Diameter  
Black Nylon  
Phillips Screw Retainers  
Acura # 90505-SL0-003  
Chrysler # MB888869  
G.M. # 9485236  
Toyota # 90467-08155

5 Pcs.



**12916PK** 23/64" (9mm) Hole Size  
12mm Stem Length  
16mm Flange Diameter  
Black Nylon Bumper  
Phillips Screw Retainers  
G.M. # 30008324  
Suzuki # 09409-07325

15 Pcs.



**9202PK** 25/64" (10mm) Hole Size  
15mm Stem Length  
20mm Flange Diameter  
Black Nylon  
Front & Rear Bumper  
Phillips Screw Retainers  
Acura # 91503-SP0-003  
BMW # 07-13-0-702-966  
G.M. # 94530623

15 Pcs.



**11138PK** 13/32" (10.30mm) Hole Size  
1" Stem Length  
27/32" Flange Diameter  
Black Nylon  
Phillips Screw Retainers  
Ford # W708325-S300  
G.M. # 11561353, 15672330, 15956470

25 Pcs.



**1730PK** 15/32" (12mm) Hole Size  
25mm Stem Length  
21mm Flange Diameter  
3mm Shoulder Length  
Black Nylon Rear Fascia  
Phillips Screw Retainers  
Chrysler # 6502625  
G.M. # 10140480

25 Pcs.



**10540PK** 9.00 - 13.00mm Hole Size  
15mm Stem Length  
19.00 x 30.00mm Flange Size  
Black & Gray Nylon  
Radiator Grille Retainers  
G.M. # 15764320, 15025531

10 Pcs.



## Retainers Slotted Screw

**10608PK** 25mm Width  
34mm Length  
Black Nylon  
Front Fender &  
Bumper Cover Clips  
Use With # 10609  
G.M. # 19183888  
Toyota # 53879-58010, 53879-02070

10 Pcs.



**10609PK** 25mm Stem Length  
15mm Head Diameter  
Black Nylon  
Front Fender & Bumper Cover Pins  
Use With # 10608  
G.M. # 19183917  
Toyota # 47749-58010



10 Pcs.





18



# General Motors



## Retainers Torx Screw



<b>11234PK</b>	15/64" (6mm) Hole Size 18mm Stem Length 11mm Flange Diameter Black Nylon Torx Screw Type Retainers Chrysler # 55075139 Ford # W713134-S300 G.M. # 10089262, 21042098	<b>25 Pcs.</b>		
----------------	---	----------------	---	---

## Clips Door Rod End

<b>9437PK</b>	5/32" Rod Size 15/64" Hole Size Left Hand Side Black Nylon Door Lock Rod Clips G.M. # 20582532, 20633148	<b>25 Pcs.</b>		
---------------	---	----------------	---	---

<b>9438PK</b>	5/32" Rod Size 15/64" Hole Size Right Hand Side Natural Nylon Door Lock Rod Clips G.M. # 20582533, 20633149	<b>25 Pcs.</b>		
---------------	--	----------------	---	---



<b>9439PK</b>	3/16" Rod Size Natural Nylon Tailgate Lock Rod Clips G.M. # 15545178, 14037239	<b>10 Pcs.</b>		
---------------	---	----------------	--	---

<b>1249PK</b>	5/32" Rod Size 15/64" Hole Size Right Hand Side Red Nylon Door Lock Rod Clips Chrysler # 3454220, 4658676 G.M. # 88981031	<b>50 Pcs.</b>		
---------------	---	----------------	---	--

<b>1250PK</b>	5/32" Rod Size 15/64" Hole Size Left Hand Side Green Nylon Door Lock Rod Clips Chrysler # 3454221, 4658677 G.M. # 8898130	<b>50 Pcs.</b>		
---------------	---	----------------	--	---

<b>9725PK</b>	5/32" Rod Size 17/64" Hole Size Right Hand Side Natural Nylon Door Rod & Hood Clips AMC # 4003672 Chrysler # 2945108, 4658676 Ford # N805350S G.M. # 16627328	<b>20 Pcs.</b>		
---------------	---	----------------	--	---



<b>9726PK</b>	5/32" Rod Size 17/64" Hole Size Left Hand Side Black Nylon Door Rod & Hood Clips AMC # 4003673 Chrysler # 2945109, 4658677 Ford # N804344S, D2VZ-652195A G.M. # 9815325, 16607593	<b>50 Pcs.</b>		
---------------	---	----------------	---	---



<b>9960PK</b>	5/32" Rod Size 15/64" Hole Size Left Hand Side Black Nylon Door Lock Rod Clips Chrysler # 5257479, 4658677 G.M. # 16630689	<b>25 Pcs.</b>		
---------------	--	----------------	--	---

18

# General Motors



## Clips Door Rod End



<b>9959PK</b>	13/64" Rod Size 15/64" Hole Size Right Hand Side Natural Nylon Door Lock Rod Clips Chrysler # 5257478, 4658676 G.M. # 16630688	<b>25 Pcs.</b>		
---------------	--	----------------	--	---

<b>9731PK</b>	4mm Rod Size 6mm Hole Size Yellow Nylon Door Lock Rod Clips G.M. # 16606936, 16633853	<b>100 Pcs.</b>		
---------------	---	-----------------	--	---

<b>1083PK</b>	Door Lock Rod End Clips G.M. # 4234830, 12337868	<b>25 Pcs.</b>		
---------------	--	----------------	---	--

## Clips Tailgate Lock Rod End

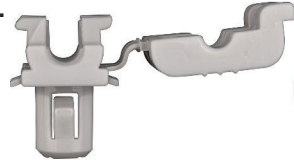

<b>9981PK</b>	10-24 Rod Size 2mm Panel Range 8mm Hole Size Yellow Nylon Door Lock & Tailgate Rod Clips Ford # F65Z-1521952-AA, F7DZ-7421952-A G.M. # 16629990, 16675980	<b>15 Pcs.</b>		
---------------	--	----------------	--	---

<b>16391PK</b>	10-24 Rod Size 2mm Panel Range 8mm Hole Size Gray Nylon Door Lock & Tailgate Rod Clips Ford # F65Z-1521952-AA, F7DZ-7421952-AA G.M. # 16629990, 16675980, 16640343	<b>15 Pcs.</b>		
----------------	---	----------------	---	--

## Retainers Door Trim Panel

<b>18783PK</b>	15/64" (6mm) Hole Size 8mm Stem Length 10mm Top Head Diameter Orange Nylon Door Panel Retainers GM # 11603260	<b>50 Pcs.</b>		
----------------	--	----------------	--	---

<b>15985PK</b>	15/64" (6mm) Hole Size 9mm Stem Length 10mm Top Head Diameter White Nylon Door Panel Retainers G.M. # 11602522, 11603260	<b>25 Pcs.</b>		
----------------	---	----------------	--	---



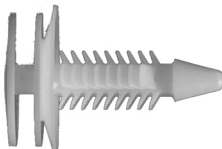









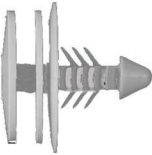

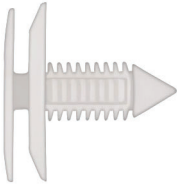

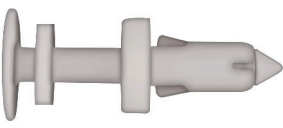
<b>9582PK</b>	15/64" (6mm) Hole Size 10mm Stem Length 10mm Top Head Diameter White Nylon Door Trim Panel Retainers G.M. # 90560163	<b>25 Pcs.</b>		
---------------	---	----------------	--	---

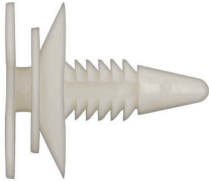
<b>9861PK</b>	15/64" (6mm) Hole Size 24mm Stem Length 18mm Top Head Diameter White Nylon Door Trim Panel Retainers G.M. # 10285935	<b>50 Pcs.</b>		
---------------	---	----------------	--	---

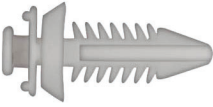
18

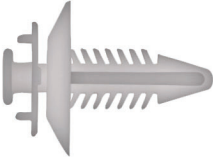
# General Motors

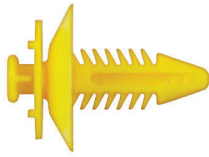

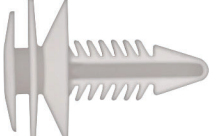









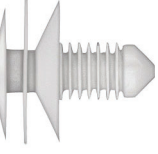

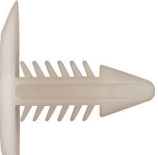

## Retainers Door Trim Panel

<b>16311PK</b>	1/4" (6.50mm) Hole Size 9.30mm Stem Length 15mm Flange White Nylon With Sealer Interior Door Trim & Exterior Moulding Retainers G.M. # 11610700	<b>15 Pcs.</b>		
<b>9860PK</b>	1/4" (6.30mm) Hole Size 13mm Stem Length 18mm Head Diameter White Nylon Door Trim Panel Retainers G.M. # 10287971	<b>50 Pcs.</b>		
<b>10399PK</b>	1/4" (6.30mm) Hole Size 3/4" Stem Length 15/16" Top Head Diameter Natural Nylon Door Trim Panel Retainers G.M. # 20480475	<b>50 Pcs.</b>		
<b>2029PK</b>	1/4" (6.30mm) Hole Size 16.30mm Stem Length 14.30mm Head Diameter White Nylon Door Trim Panel Push Type Retainers G.M. # 15960325	<b>50 Pcs.</b>		
<b>5264PK</b>	1/4" (6.30mm) Hole Size 29/32" Stem Length 29/32" Top Head Diameter Natural Nylon Door Trim Panel Retainers G.M. # 3065575, 16656935X	<b>50 Pcs.</b>		
<b>1646PK</b>	1/4" (6.50mm) Hole Size 21mm Stem Length 6.30 x 11.50mm Top Head Size Natural Nylon Door Trim Panel Retainers G.M. # 15545202	<b>50 Pcs.</b>		
<b>4020PK</b>	1/4" (6.50mm) Hole Size 21mm Stem Length 6.30 x 11.50mm Top Head Size Natural Nylon Door Trim Panel Retainers G.M. # 20421800, 15600382	<b>25 Pcs.</b>		
<b>9349PK</b>	1/4" (6.50mm) Hole Size 21mm Stem Length 6.30 x 11.70mm Top Head Size Yellow Nylon Door Trim Panel Retainers G.M. # 15588024, 15596301	<b>25 Pcs.</b>		
<b>9242PK</b>	1/4" (6.50mm) Hole Size 21mm Stem Length 17mm Head Diameter Natural Nylon Door Trim Panel Retainers G.M. # 12337920, 20374473	<b>50 Pcs.</b>		

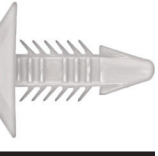
18

# General Motors



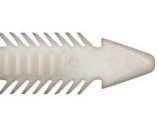









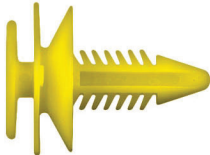

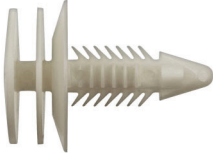
## Retainers Door Trim Panel

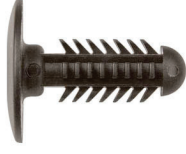
<b>10543PK</b>	9/32" (7mm) Hole Size 14mm Stem Length 18mm Top Head Diameter Yellow Nylon Door Garnish Moulding & Pillar Trim Panel Retainers G.M. # 10408480	<b>50 Pcs.</b>		
<b>592PK</b>	9/32" (7mm) Hole Size 14.80mm Stem Length 17.60mm Head Diameter Natural Nylon Door Trim Panel Retainers G.M. # 2064891, 9818648, 9883583	<b>50 Pcs.</b>		
<b>2017PK</b>	9/32" (7mm) Hole Size 16mm Stem Length 14mm Top Head Diameter Black Nylon Door Trim Panel Retainers G.M. # 15638413, 15963179	<b>50 Pcs.</b>		
<b>9373PK</b>	9/32" (7mm) Hole Size 18mm Stem Length 13mm Head Diameter Black Nylon Door Trim Panel Retainers AMC # 4005099 Chrysler # 6033862 G.M. # 796255 Navistar # 0501094C1	<b>25 Pcs.</b>		
<b>1024PK</b>	9/32" (7mm) Hole Size 18mm Stem Length 20mm Top Head Diameter Natural Nylon Door Trim Panel Retainers AMC # 4005470 Chrysler # 6003349 G.M. # 9685057 V.W. # N98905101	<b>25 Pcs.</b>		
<b>9339PK</b>	9/32" (7mm) Hole Size 19mm Stem Length 7.00 x 12.50mm Top Head Size White Nylon Door Trim Panel Retainers G.M. # 15612948, 15607165	<b>25 Pcs.</b>		
<b>9224PK</b>	9/32" (7mm) Hole Size 19mm Stem Length 13.20mm Top Head Diameter Natural Nylon Door Trim Panel Retainers Ford # W707741-S300 G.M. # 21042045, 21042053, 21042058, 21042104	<b>50 Pcs.</b>		
<b>1558PK</b>	9/32" (7mm) Hole Size 19mm Stem Length 13.30mm Top Head Diameter Natural Nylon Door Trim Panel Retainers Ford # N802900 G.M. # 21042958	<b>25 Pcs.</b>		
<b>10653PK</b>	9/32" (7mm) Hole Size 20mm Stem Length 7.00 x 12.50mm Top Head Size Natural Nylon Door Trim Panel Retainers G.M. # 15953247	<b>50 Pcs.</b>		

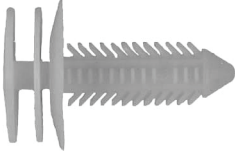
18

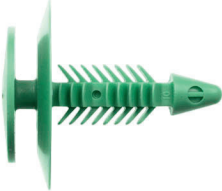
# General Motors

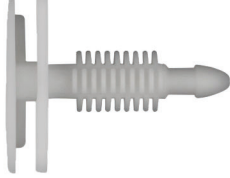
## Retainers Door Trim Panel

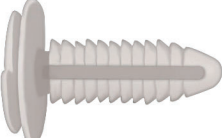
<b>10520PK</b>	9/32" (7mm) Hole Size 20.60mm Stem Length 18mm Top Head Diameter White Nylon Door Trim Panel Retainers G.M. # 10305191	<b>50 Pcs.</b>		
<b>10398PK</b>	9/32" (7mm) Hole Size 21mm Stem Length 16mm Top Head Diameter Yellow Nylon Door Trim Panel Retainers G.M. # 20734005	<b>50 Pcs.</b>		
<b>12504PK</b>	9/32" (7mm) Hole Size 21mm Stem Length 18mm Top Head Diameter White Nylon Door Trim Panel Retainer G.M. # 15986673	<b>50 Pcs.</b>		
<b>10403PK</b>	9/32" (7mm) Hole Size 22mm Stem Length 19mm Head Diameter Black Nylon Door Trim Panel Retainers G.M. # 25601491	<b>50 Pcs.</b>		
<b>1807PK</b>	9/32" (7mm) Hole Size 24mm Stem Length 18mm Top Head Diameter White Nylon Door Trim Panel Retainers G.M. # 10153057	<b>25 Pcs.</b>		
<b>10495PK</b>	9/32" (7mm) Hole Size 24mm Stem Length 18mm Top Head Diameter Green Nylon Door Trim Panel Retainers G.M. # 11588863	<b>25 Pcs.</b>		
<b>1648PK</b>	9/32" (7mm) Hole Size 24mm Stem Length 20mm Top Head Diameter White Nylon Door Trim Panel Retainers Ford # 387496-S G.M. # 12084605	<b>25 Pcs.</b>		
<b>1716PK</b>	9/32" (7mm) Hole Size 25mm Stem Length 17mm Top Head Diameter Natural Nylon Door Trim Panel Retainers G.M. # 363137	<b>100 Pcs.</b>		

18











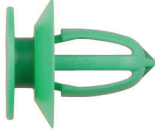

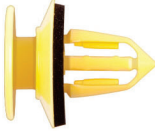

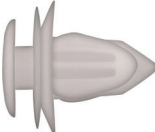

# General Motors

## Retainers Door Trim Panel

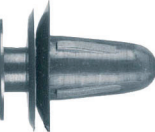
<b>9502PK</b>	9/32" (7mm) Hole Size 27mm Stem Length 22mm Top Head Diameter White Nylon Door Trim Panel Retainers G.M. # 20451401	<b>25 Pcs.</b>		
<b>11041PK</b>	9/32" (7mm) Hole Size 1 5/32" Stem Length 1/2" Top Head Diameter Natural Nylon Door Trim Panel Retainers G.M. # 15694099	<b>15 Pcs.</b>		
<b>9368PK</b>	9/32" (7mm) Hole Size 32mm Stem Length 20mm Top Head Diameter Natural Nylon Door Trim Panel Retainers G.M. # 10126901	<b>50 Pcs.</b>		
<b>16469PK</b>	7.50 x 10.00mm Stem Size 15mm Stem Length 13mm Top Head Diameter White Nylon With Sealer Trunk & Liftgate Retainers G.M. # 11569810	<b>25 Pcs.</b>		
<b>12044PK</b>	5/16" (8mm) Hole Size 13mm Stem Length 13mm Top Head Diameter Blue Nylon Door Trim Panel Retainers G.M. # 132522118	<b>25 Pcs.</b>		
<b>10703PK</b>	5/16" (8mm) Hole Size 14mm Stem Length 13mm Top Head Diameter White Nylon Door Trim Panel Retainers G.M. # 90321122	<b>50 Pcs.</b>		
<b>18345PK</b>	5/16" (8mm) Hole Size 14mm Stem Length 13mm Top Head Size Gray Nylon Door Panel Retainers G.M. # 11546963, 11547601	<b>25 Pcs.</b>		
<b>12844PK</b>	5/16" (8mm) Hole Size 14mm Stem Length 13mm Top Head Diameter Gray Nylon Door Trim Panel Retainers G.M. # 11610605	<b>25 Pcs.</b>		
<b>16408PK</b>	5/16" (8mm) Hole Size 14mm Stem Length 15mm Top Head Size Yellow Nylon With Sealer Trim Panel Retainers G.M. # 11546588, 11547577	<b>15 Pcs.</b>		

# General Motors

## Retainers Door Trim Panel

<b>12043PK</b>	5/16" (8mm) Hole Size 14mm Stem Length 17mm Head Diameter Green Nylon Door Trim Panel Retainers G.M. # 13252119	<b>25 Pcs.</b>		
<b>11961PK</b>	5/16" (8mm) Hole Size 15mm Stem Length 17mm Head Diameter Yellow Nylon Door Trim Panel Retainers G.M. # 11610606, 11546954, 11547602	<b>25 Pcs.</b>		
<b>1742PK</b>	5/16" (8mm) Hole Size 1" Stem Length 1/2" Top Head Diameter Natural Nylon Door Trim Panel Retainers AMC # 893202-599, 8934-202-599 Ford # N805612-S100, N805612-S G.M. # 10143422	<b>50 Pcs.</b>		
<b>12894PK</b>	5/16" (8mm) Hole Size 32mm Stem Length 19mm Head Diameter Green Nylon With Sealer Door Trim Panel Retainers G.M. # 25707329	<b>10 Pcs.</b>		
<b>12828PK</b>	21/64" (8.50mm) Hole Size 14mm Stem Length 13mm Top Head Diameter White Nylon Door Trim Panel Retainers G.M. # 94858299, 94178705 Toyota # 90467-10161, 90467-A0006	<b>25 Pcs.</b>		
<b>1588PK</b>	21/64" (8.50mm) Hole Size 14mm Stem Length 13mm Top Head Diameter Black Nylon Door Trim Panel Retainers G.M. # 95005064 Toyota # 67771-01010	<b>25 Pcs.</b>		
<b>10744PK</b>	23/64" (9mm) Hole Size 10mm Stem Length 13mm Head Diameter Natural Nylon Trim Panel Retainers G.M. # 94530565 Hyundai # 82315-38000	<b>25 Pcs.</b>		
<b>10748PK</b>	23/64" (9mm) Hole Size 13mm Stem Length 13mm Top Head Diameter White Nylon Door Panel & Rocker Moulding Clips G.M. # 88970656 Toyota # 67771-12080	<b>15 Pcs.</b>		
<b>9081PK</b>	23/64" (9mm) Hole Size 14mm Stem Length 13mm Top Head Diameter Natural Nylon Door Trim Panel Retainers G.M. # 94226492 Isuzu # 8-94226-492-0, Mazda # 9927-40-825, Toyota # 67771-01010, 67771-12010F	<b>25 Pcs.</b>		

18

# General Motors

## Retainers Door Trim Panel

<b>11366PK</b>	23/64" (9mm) Hole Size 15mm Stem Length 13mm Top Head Diameter Yellow Nylon Door Trim Panel Retainers G.M. # 95008221 Mitsubishi # MB608104 Toyota # 67771-30090	<b>15 Pcs.</b>		
<b>12559PK</b>	23/64" (9mm) Hole Size 15mm Stem Length 13mm Top Head Diameter Maroon Nylon Trim Panel Retainers G.M. # 30006620 Toyota # 67771-12050	<b>15 Pcs.</b>		
<b>16091PK</b>	23/64" (9mm) Hole Size 17mm Stem Length 15mm Top Head Diameter Natural Nylon With Sealer Door Trim Panel Retainers G.M. # 11549307	<b>15 Pcs.</b>		
<b>12105PK</b>	23/64" (9mm) Hole Size 18mm Stem Length 13mm Top Head Diameter Yellow Nylon With Sealer Door Trim Panel Retainers G.M. # 22600612, 22651066	<b>25 Pcs.</b>		
<b>12895PK</b>	23/64" (9mm) Hole Size 27.80mm Overall Length 19.50mm Head Diameter Green Nylon With Sealer Door Trim Panel Retainers G.M. # 25704141, 25762391	<b>10 Pcs.</b>		
<b>10701PK</b>	3/8" (9.50mm) Hole Size 17.00mm Stem Length 19.50mm Top Head Diameter White Nylon With Sealer Door Trim Panel Retainers Ford # W711521-S300 G.M. # 11519031	<b>15 Pcs.</b>		
<b>11960PK</b>	6.50 x 12.00mm Hole Size Black Nylon Instrument Panel Insulation Front Sight Shield Twist Lock Retainers Ford # N811772S G.M. # 2553596	<b>25 Pcs.</b>		
<b>18217PK</b>	7/16" (11mm) Hole Size 7/16" Stem Length 15/32 x 25/32" Top Head Size White Nylon With Sealer Door Trim Panel Retainers G.M. # 91176726	<b>15 Pcs.</b>		
<b>12842PK</b>	7/16" (11mm) Hole Size 17mm Stem Length 20mm Top Head Diameter White Nylon Door Trim Panel Retainers G.M. # 15076791	<b>15 Pcs.</b>		

18

# General Motors

## Retainers Door Trim Panel

**18474PK** 13mm Stem Length  
16.50 x 25.00mm Head Size  
Black Nylon  
Door Panel Retainers  
G.M. # 11547446

10 Pcs.



## Retainers Door Panel Pin & Grommet

**10474PK** 13mm Top Head Diameter  
26.50mm Pin Length  
White Nylon  
Door Panel Pins  
Use With # 10476  
G.M. # 10363811, 22722859

25 Pcs.



**10473PK** 19.50mm Top Head Diameter  
28.30mm Pin Length  
White Nylon  
Door Panel Pins  
Use With # 10476  
G.M. # 11561499

25 Pcs.



**10472PK** 19.50mm Top Head Diameter  
28.30mm Pin Length  
Black Nylon  
Door Panel Pins  
Use With # 10476  
G.M. # 11562241

25 Pcs.



**10471PK** 19.50mm Top Head Diameter  
30.40mm Pin Length  
Green Nylon  
Door Panel Pins  
Use With # 10478  
G.M. # 11562242

25 Pcs.



**10470PK** 19.50mm Top Head Diameter  
30.40mm Pin Length  
Yellow Nylon  
Door Panel Pins  
Use With # 10478 & 10476  
G.M. # 11561600

25 Pcs.

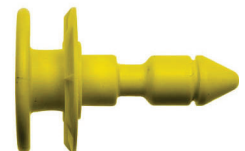

**10476PK** 23/64" (9mm) Hole Size  
White Nylon With Sealer  
Door Panel Grommets  
Use with # 10470, 10472, 10473 & 10474  
G.M. # 22722860

25 Pcs.



**10478PK** 23/64" (9mm) Hole Size  
Yellow Nylon With Sealer  
Door Panel Grommets  
Use With # 10470 & 10471  
G.M. # 11561500

25 Pcs.

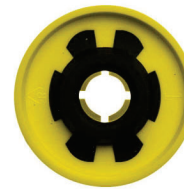

18

# General Motors

## Retainers Door Panel Pin & Grommet

<b>12049PK</b>	15mm Top Head Diameter 34mm Stem Length Natural Nylon Door Trim Panel Retainers Use With # 12050 G.M. # 10350983	<b>15 Pcs.</b>		
<b>12050PK</b>	9/32" (7mm) Hole Size 15mm Stem Length 12.00 x 14.50mm Head Size Natural Nylon Door Trim Panel Grommets Use With # 12049 G.M. # 10351052	<b>15 Pcs.</b>		
<b>10135PK</b>	23/64" (9mm) Hole Size 17.50mm Stem Length Two Part Pin & Nut White Nylon With Sealer Door Trim Panel Retainers G.M. # 11571118	<b>15 Pcs.</b>		
<b>10136PK</b>	23/64" (9mm) Hole Size 17.50mm Stem Length Two Part Pin & Nut Yellow Nylon With Sealer Door Trim Panel Retainers G.M. # 11571119	<b>15 Pcs.</b>		

## Set Door Panel Pin & Grommet

<b>10529</b>	23/64" (9mm) Hole Size Yellow Pin Yellow Grommet With Sealer Two Part Nylon Door Panel Retainers G.M. # 11562044	<b>15 Pcs.</b>		
<b>10530</b>	23/64" (9mm) Hole Size Yellow Pin White Grommet With Sealer Two Part Nylon Door Panel Retainers	<b>15 Pcs.</b>		
<b>10531</b>	23/64" (9mm) Hole Size White Pin White Grommet With Sealer Two Part Nylon Door Panel Retainers G.M. # 11562043	<b>15 Pcs.</b>		
<b>10532</b>	23/64" (9mm) Hole Size White Pin White Grommet With Sealer Two Part Nylon Door Panel Retainers G.M. # 22699649, 22704458, 22713392, 11562287	<b>25 Pcs.</b>		

18

# General Motors

## Set Door Panel Pin & Grommet

<b>10533</b>	23/64" (9mm) Hole Size Black Pin White Grommet With Sealer Two Part Nylon Door Panel Retainers G.M. # 11562256	<b>15 Pcs.</b>	
--------------	---	----------------	---

<b>10534</b>	23/64" (9mm) Hole Size Green Pin Yellow Grommet With Sealer Two Part Nylon Door Panel Retainers G.M. # 11562257	<b>15 Pcs.</b>	
--------------	--	----------------	---

18

## Retainers Door Panel Wire

<b>9900PK</b>	5/16" (8mm) Hole Size Bright Zinc Finish Trim Panel Fasteners G.M. # 4114785	<b>50 Pcs.</b>	
---------------	---	----------------	---

<b>11876PK</b>	12mm Width 15mm Height Organic Zinc Finish Windshield & Side Door Garnish Moulding Liftgate Trim Panel Retainers Chrysler # 6502988 G.M. # 16662182, 25580123	<b>15 Pcs.</b>	
----------------	---	----------------	--

<b>10700PK</b>	15/32" Width 11/16" Height Bright Zinc Finish Interior Trim, Garnish, Bezel & Scuff Plate Fasteners G.M. # 11588650	<b>10 Pcs.</b>	
----------------	--	----------------	---

<b>10090PK</b>	6-1.00mm Screw Size Zinc Organic Door Trim Panel Retainer Nuts G.M. # 11517769	<b>10 Pcs.</b>	
----------------	---	----------------	---















<b>13414PK</b>	13/16" Width 15/16" Length Black Finish Front Door Interior Trim & Instrument Panel Fasteners G.M. # 15683327	<b>10 Pcs.</b>	
----------------	--	----------------	--

## Ferrules Door Lock

<b>9221PK</b>	13/16" Outside Diameter Polished Stainless Steel With Felt Insert Door Lock Rod Ferrule G.M. # 330485, 9665901	<b>25 Pcs.</b>	
---------------	--	----------------	--

# General Motors

## Bushings Door Hinge Pin

<b>9233PK</b>	21/64" Inside Diameter 9/16" Outside Diameter 1/64" Thick Stainless Steel Door Hinge Pin Retainers Use With # 9164 G.M. # 15562610	<b>50 Pcs.</b>		
<b>1267PK</b>	.345" Inside Diameter .419" Outside Diameter .295" Height Door Hinge Pin Bushings Ford # D1AZ-6522841A G.M. # 9721917	<b>25 Pcs.</b>		
<b>1268PK</b>	.345" Inside Diameter .489" Outside Diameter .362" Height Door Hinge Pin Bushings G.M. # 20429500	<b>25 Pcs.</b>		
<b>2114PK</b>	.345" Inside Diameter .495" Outside Diameter .365" Height Door Hinge Pin Bushings G.M. # 12338074, 15964971, 15691493, 16632193	<b>25 Pcs.</b>		
<b>1252PK</b>	.346" Inside Diameter .490" Outside Diameter .375" Height Door Hinge Pin Bushings G.M. # 9716926, 20345137	<b>25 Pcs.</b>		
<b>1251PK</b>	.384" Inside Diameter .501" Outside Diameter .460" Height Door Hinge Pin Bushings G.M. # 9822198	<b>25 Pcs.</b>		
<b>2115PK</b>	.385" Inside Diameter .530" Outside Diameter .365" Height Door Hinge Pin Bushings G.M. # 15562609, 6632192, 5964972	<b>25 Pcs.</b>		

## Pins Door Hinge



<b>1289PK</b>	4" Overall Length 11/32" Pin Diameter 7/16" Head Outside Diameter Black Zinc Finish Door Hinge Pins G.M. # 20043351, 20043361	<b>10 Pcs.</b>
---------------	--	----------------

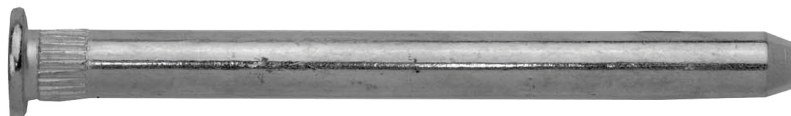

<b>1288PK</b>	4 1/16" Overall Length 11/32" Pin Diameter 9/16" Head Outside Diameter Bright Zinc Finish Door Hinge Pins G.M. # 6271989, 20046147	<b>10 Pcs.</b>
---------------	---	----------------

# General Motors

## Pins Door Hinge



(Yellow Zinc Finish)

**9825PK**

4 1/8" Length  
11/32" Pin Diameter  
1/2" Head Outsider Diameter  
Yellow Zinc Steel  
Door Hinge Pins  
G.M. # 15653790

**2 Pcs.**



(Stainless Steel)

**9164PK**

5 1/4" Length  
11/32" Pin Diameter  
9/32" Head Outside Diameter  
Stainless Steel  
Door Hinge Pins  
G.M. # 15591860, 15691595, 15691595X,  
15967691, 15685040, 88891731

**5 Pcs.**



**2168PK**

5 1/2" Length  
9/16" Pin Diameter  
5/8" Roller Groove Diameter  
19/32" Knurl Diameter  
Door Roller Pin Assembly  
G.M. # 12540326

**Sold Each**

## Kits Door Hinge Pin & Bushing



(Stainless Steel Pin)

**9818**

G.M. Trucks C-K 1988-On  
Kit Will Repair One Hinge  
Stainless Steel  
Door Hinge Pin & Bushing Kit

**1 Kit**

18

# General Motors

## Kits Door Hinge Pin & Bushing

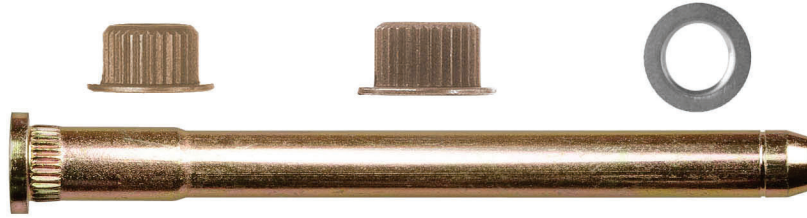

**9832**

G.M. S10 Trucks  
1994-On  
Kit Will Fix One Hinge  
Door Hinge Pin & Bushing Kit

**1 Kit**

18



**9833**

G.M. S10 Trucks  
1994-On  
Kit Will Fix One Door  
Door Hinge Pin & Bushing Kit

**1 Kit**

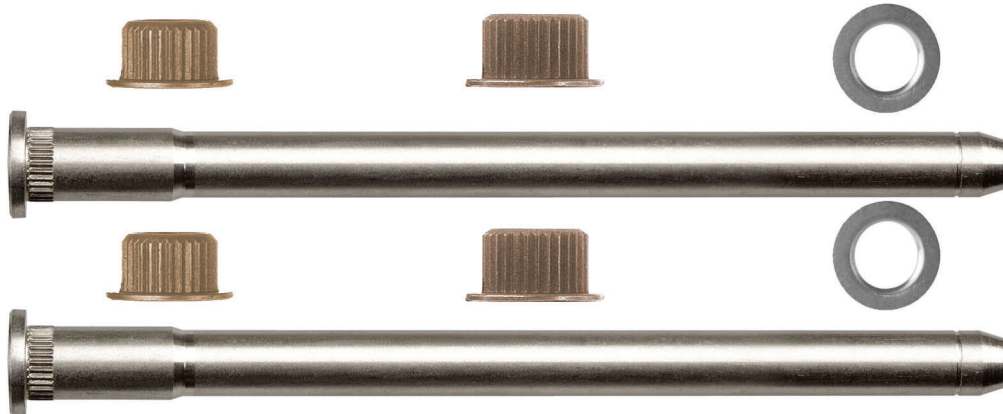

**9905**

G.M. Trucks C-K 1988-On  
Kit Will Repair One Door  
Stainless Steel  
Door Hinge Pin & Bushing Kit

**1 Kit**

# General Motors

## Kits Door Hinge Pin & Bushing



**10060**

GMC Sierra & Chevrolet Silverado  
& Other S.U.V 'S Hinges  
Kit Will Repair One Hinge  
Yellow Zinc Finish  
Door Hinge Pin & Bushing Kit

**1 Kit**

18

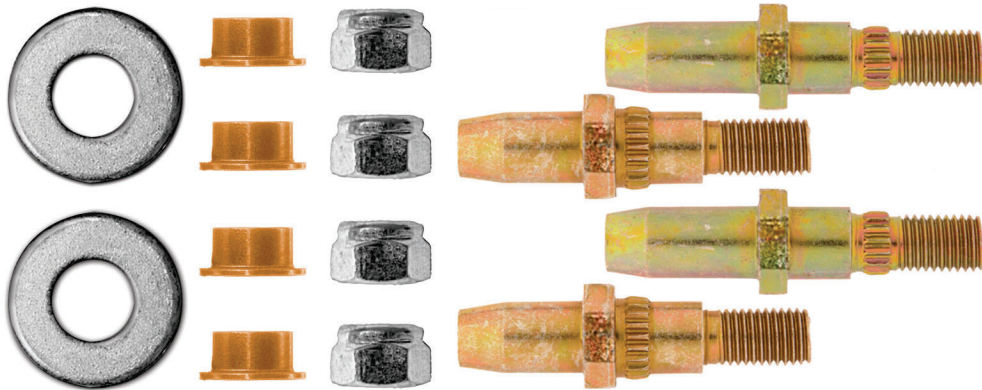

**10065**

GMC Sierra & Chevrolet Silverado  
& Other S.U.V 'S Hinges  
To Repair One Door  
Yellow Zinc Finish  
Door Hinge Pin & Bushing Kit

**1 Kit**

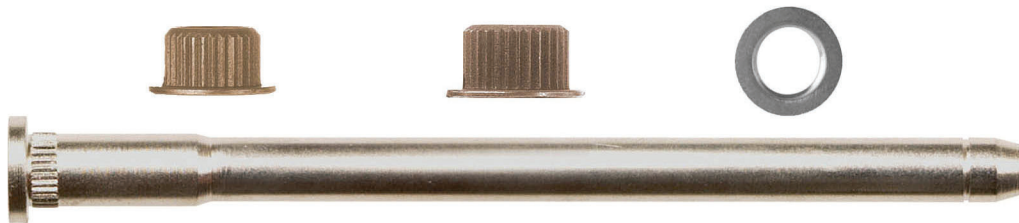

**10527**

G.M. Trucks C-K 1988-On  
(Steel Pin) Kit Will Repair One Door  
Door Hinge Pin & Bushing Kit  
G.M. 15994345

**1 Kit**

# General Motors

## Kits Door Hinge Pin & Bushing

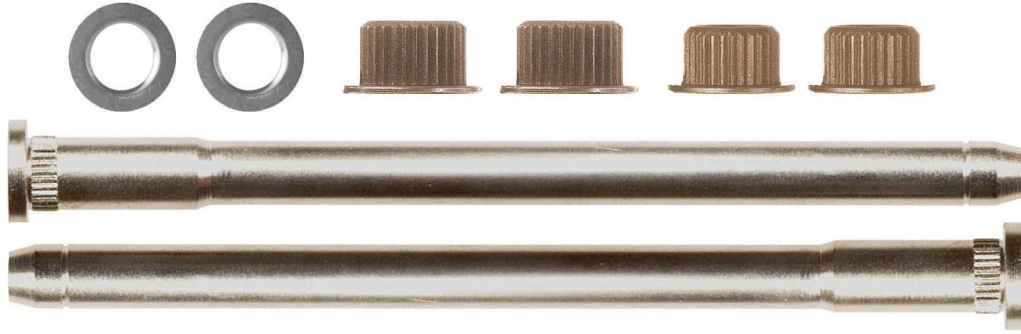

**18** 10528

G.M. Trucks C-K 1988-On  
(Steel Pin) Kit Will Repair One Door  
Door Hinge Pin & Bushing Kit

**1 Kit**



**10558**

Chevrolet Savana & GMC Express  
Van Side Doors  
Repairs One Hinge  
Greaseable Stainless Steel  
Door Hinge Pin & Bushing Kit  
G.M. # 31028283, 88944360, 89025546

**1 Kit**



**10559**

Chevrolet Savana & G.M.C. Express  
Side Cargo Door  
Replacement Hinge  
Van Side Doors  
Use With # 10699

**1 Pc.**

# General Motors

## Kits Door Hinge Pin & Bushing

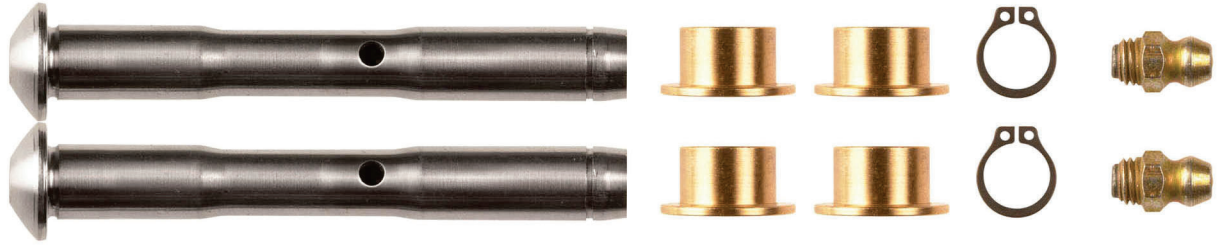

**10699**

Chevrolet Savana & GMC Express  
Van Side Doors  
Repairs One Door  
Greaseable Stainless Steel  
Door Hinge Pin & Bushing Kit  
G.M. # 89025546

**1 Kit**

18

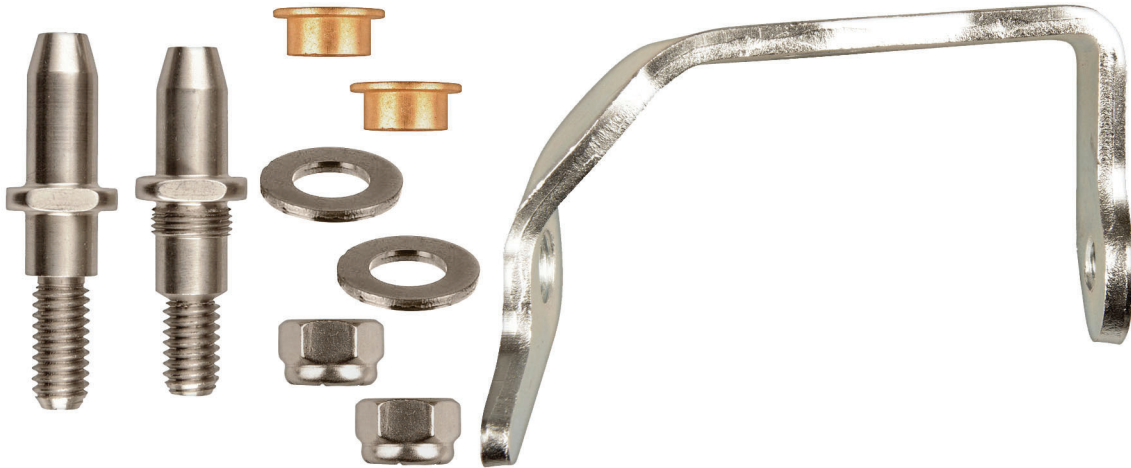

**12115**

Used On Upper Or Lower Hinge  
Will Repair One Hinge Driver Side  
Stainless Steel Pins, Nuts & Bracket  
Door Hinge Repair Kit  
Cadillac Escalade 02-06,  
Chevrolet Avalanche 02-06,  
Chevrolet Silverado 99-06,  
Chevrolet Silverado Classic 07,  
Chevrolet Suburban 00-06,  
Chevrolet Tahoe 00-05,  
GMC Sierra 99-06,  
GMC Sierra Classic SLE 07,  
GMC Yukon 02

**1 Kit**

# General Motors

## Kits Door Hinge Pin & Bushing

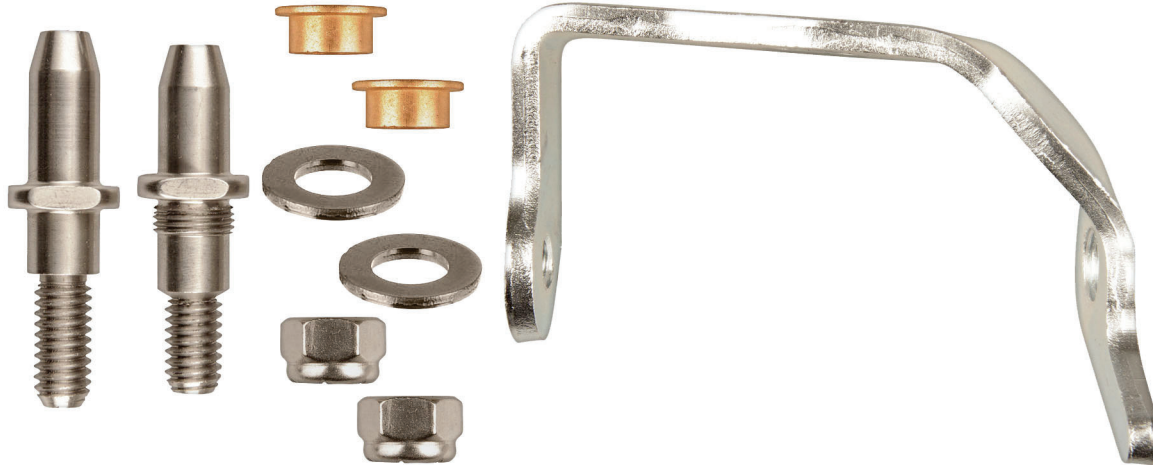

18

**12116**

Used On Upper Or Lower Hinge  
Will Repair One Hinge Passenger's Side  
Stainless Steel Pins, Nuts & Bracket  
Door Hinge Repair Kit  
Cadillac Escalade 02-06,  
Chevrolet Avalanche 02-06,  
Chevrolet Silverado 99-06,  
Chevrolet Silverado Classic 07,  
Chevrolet Suburban 00-06,  
Chevrolet Tahoe 00-05,  
GMC Sierra 99-06,  
GMC Sierra Classic SLE 07,  
GMC Yukon 02

**1 Kit**

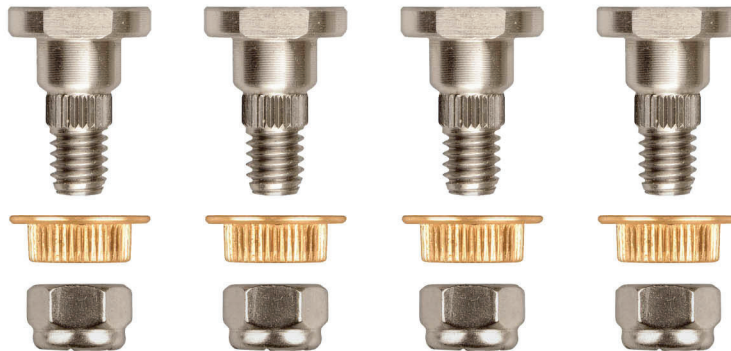

**12117**

Will Repair  
Front Door Upper  
& Lower Hinge  
Stainless Steel Pins & Nuts  
Door Hinge Pin &  
Bushing Bracket Repair Kit  
Chevrolet Cavalier & Pontiac Sunfire 95-05

**1 Kit**

# General Motors

## Kits Door Hinge Pin & Bushing



**12118**

Will Repair Upper & Lower Hinge  
 Stainless Steel Pins & Nuts  
 Door Hinge Pin &  
 Bushing Bracket Repair Kit  
 Cadillac Escalade &  
 Cadillac Escalade ESV  
 Chevrolet Avalanche 4-Door Pickup  
 Chevrolet Avalanche SUV,  
 Chevrolet Silverado  
 Chevrolet Suburban 4-Door SUV  
 Chevrolet Tahoe 4-Door SUV  
 GMC Sierra, GMC Yukon &  
 GMC Yukon XL 07-11

**1 Kit**

18



**12121**

C/K Series Trucks 07-10  
 Will Repair One Hinge  
 Used On Front Or Rear Door  
 Stainless Steel Pin  
 Door Hinge Pin & Roller Bracket Repair Kit

**1 Kit**

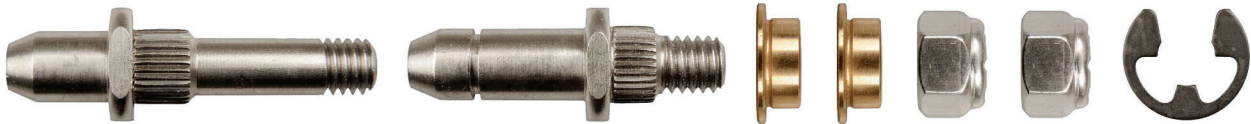

**12123**

Will Repair Extended Cab Rear Doors  
 Stainless Steel Pins  
 Door Pin & Bushing Hinge Repair Kit  
 Chevrolet Silverado (1500, 2500, 3500)  
 99-05  
 Chevrolet Silverado (1500HD, 2500HD,  
 3500HD) 01-05  
 Chevrolet Silverado (1500, 2500HD)  
 Chevrolet Silverado 1500  
 GMC Sierra (1500, 2500, 3500) 99-05  
 GMC Sierra (1500HD, 2500HD, 3500HD)  
 01-05  
 Classic Hybrid LT 06-07  
 Classic Hybrid 05-078902  
 G.M. # 89025543

**1 Kit**

# General Motors

## Retainers Door Window Guide



**9635PK** 1 5/16" Height  
6" Overall Length  
Black Plastic  
Front Door Glass  
Window Guides Retainers  
G.M. # 20180140, 22543362 **25 Pcs.**

**15010PK** 1 13/32" O.A. Length  
White Nylon  
Front Door Window Guide  
G.M. **5 Pcs.**



**1562PK** Front & Rear Door Glass  
Black Nylon  
Window Guide Retainers  
G.M. # 20328600, 10051034, 20123070,  
12338011, 10114597 **25 Pcs.**

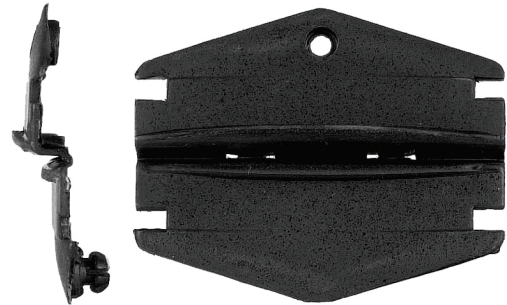

**1563PK** Upper Part of Glass  
Black Nylon  
Front Door Glass  
Window Guide Retainers  
G.M. # 20160591 **15 Pcs.**



**1566PK** Rear of Glass  
Black Nylon  
Front Door Glass  
Window Guide Retainers  
G.M. # 22539533, 20478733 **15 Pcs.**



18

# General Motors

## Retainers Door Window Guide

**1568PK** Front & Rear Door Glass  
Black Nylon  
Window Guide Retainers  
G.M. # 20162174, 22543363 **25 Pcs.**



**9631PK** Front Door Glass  
With Adhesive Gasket  
Black Plastic  
Window Guide Retainers  
G.M. # 10051034, 10114597, 12338011 **10 Pcs.**



**9222PK** Black Nylon  
Front Door Glass  
Window Guide Retainers  
G.M. # 20747509, 20478732 **15 Pcs.**



**9421PK** 2 3/4 x 1 3/4" Overall Size  
Front of Glass 4mm Thick  
Black Nylon  
Front Door Glass Window Guide Retainers  
G.M. # 20712176, 20712172, 20484630,  
20340710, 20633504, 12353912,  
20487630 **15 Pcs.**



**1681PK** 2 3/4 x 1 3/4" Overall Size  
Black Nylon  
Front Door Glass  
Window Guide Retainers  
G.M. # 12337898, 20747508, 20487631 **15 Pcs.**



18

# General Motors

## Retainers Door Window Guide

**10479PK**

Assembled Overall  
Size 1 x 2 3/8"  
Gray Nylon  
Front Door Window Guides  
G.M. # 15786626, 10274778

**10 Pcs.**

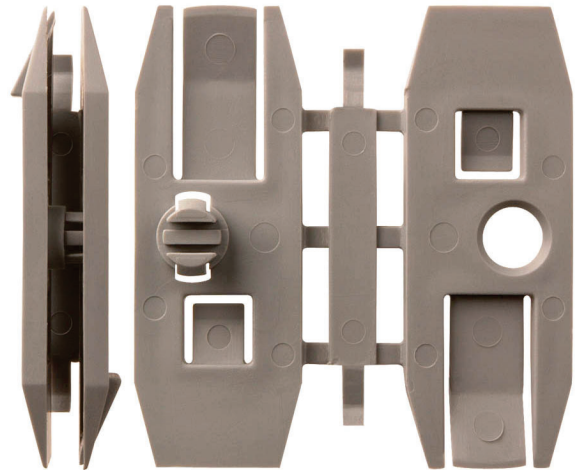

## Adjusters Headlight

**1003PK**

12-28 x 1 1/2" Screw Size  
Blue Nylon Nut  
Headlight Adjusting  
Screw & Nut Assembly  
G.M. # 556196, 557057, 559312

**25 Pcs.**

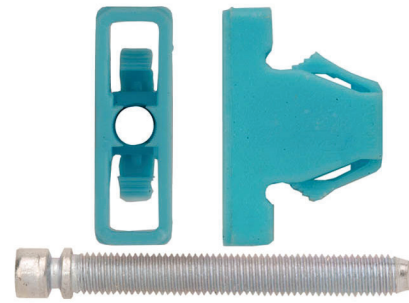

**1019PK**

1/4-28 x 2" Screw  
Green Nylon Nut  
Headlight Adjusting  
Screw & Nut Assembly  
G.M. # 365270, 365266

**25 Pcs.**



**853PK**

1/4-28 x 2" Screw  
Pink Nylon Nut  
Headlight Adjusting  
Screw & Nut Assembly  
AMC # SF4006204  
G.M. # 1606642, 1618890, 1600375

**25 Pcs.**

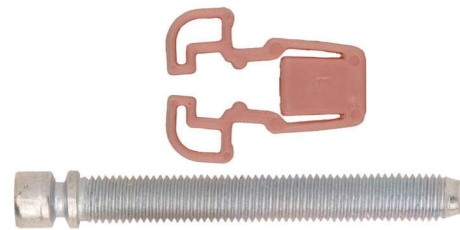

**972PK**

1/4-28 x 2" Screw Size  
White Nylon Nut  
Headlight Adjusting  
Screw & Nut Assembly  
G.M. # 343541, 343542, 343543, 343555,  
354076, 362379, 3921446, 15705372

**10 Pcs.**

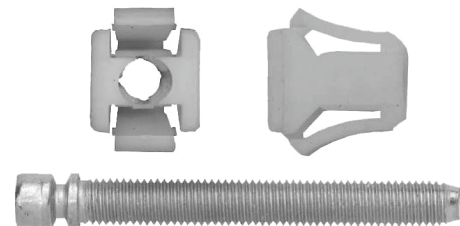

# General Motors

## Adjusters Headlight

<b>656PK</b>	1/4-28 Screw Size Natural Nylon Headlight Adjusting Nuts Use With Screw # 996 G.M. # 3921446	<b>50 Pcs.</b>		
<b>9351PK</b>	1/4-28 Screw Size White Nylon Headlight Adjusting Nuts Use With Screw # 996 G.M. # 343541, 343542, 343543, 343555, 354076, 362379	<b>50 Pcs.</b>		
<b>996PK</b>	1/4-28 x 2" Screw Bright Zinc Finish Headlight Adjusting Screws Use With Nut # 9351 & 656 G.M. # 343543, 354076, 9438150, 9432645	<b>25 Pcs.</b>		

18

## Retainers Headlight

<b>1107PK</b>	#8 Screw Size Retainers Headlight Panel G.M. # 25501771	<b>50 Pcs.</b>		
---------------	---	----------------	--	--



<b>10106PK</b>	1 1/8" Width 4 9/16" Length Natural Nylon Headlight Retainers G.M. # 10298115	<b>10 Pcs.</b>		
----------------	---	----------------	--	--

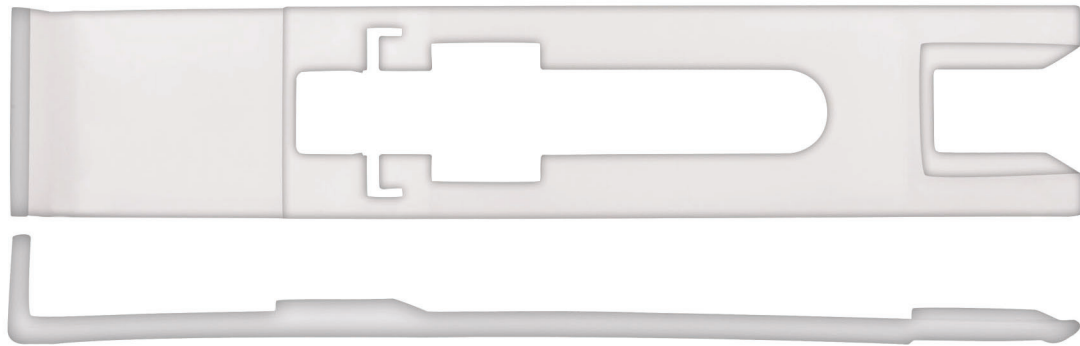

<b>13036PK</b>	1 1/8" Width 5 9/16" Length White Nylon Headlight Retainers G.M. # 15281294	<b>10 Pcs.</b>		
----------------	---	----------------	--	--

# General Motors

## Retainers Grille













11211PK	14mm Width 14mm Height White Nylon Grille Clips G.M. # 5482087	25 Pcs.		
9082PK	13mm Width 22mm Overall Length Black Plastic Grille Headlight Clips G.M. # 94218027, H200-50-715 Isuzu # 8942180270, 58974-00008 Mazda # B092-50-715, BF67-S0715 Mitsubishi # MB153825 Toyota # 90467-13011, 90467-12020	25 Pcs.		
16452PK	8 x 25.40mm Hole Size 15.50mm High 16.50 x 26.50mm Head Zinc with Blue Topcoat Radiator Grille & Quarter Trim Panel Retainers G.M. # 11519069	15 Pcs.		
10633PK	5/8" Width 1" Length 5/8" Overall Height Black Finish Radiator Grille & Bumper Cover Fasteners G.M. # 15078238, 10533681, 15162843	15 Pcs.		
9809PK	Zinc Plated Radiator Grille Retainers G.M. # 15002520, 15682898, 15709521	25 Pcs.		

## Retainers Reveal Moulding







986PK	15.25mm Width 30.50mm Length Light Green Nylon Windshield & Rear Window Reveal Moulding Clips G.M. # 1654047	100 Pcs.		
816PK	16mm Width 18.50mm Length Green Finish Rear Window Reveal Moulding Clips G.M. # 4533699, 4506041	100 Pcs.		
2065PK	16mm Width 23mm Length Silver Finish Windshield & Rear Window Reveal Moulding Clips G.M. # 9808241	50 Pcs.		
9898PK	16.25mm Width 23mm Length Silver Finish Windshield Upper & Lower Reveal Moulding Clips G.M. # 7698976	100 Pcs.		

# General Motors

## Retainers Reveal Moulding

















<b>9546PK</b>	16.75mm Width 34.75mm Length Yellow Zinc Finish Windshield and Rear Window Reveal Moulding Clips G.M. # 7693140, 8736586	<b>50 Pcs.</b>		
<b>825PK</b>	17.50mm Width 23.25mm Length Black Finish Rear Window Reveal Moulding Clips G.M. # 8717859, 9854717	<b>100 Pcs.</b>		
<b>985PK</b>	17.50mm Width 31.50mm Length White Nylon Windshield to Panel Reveal Moulding Clips AMC # 4005540 G.M. # 9731301	<b>100 Pcs.</b>		
<b>817PK</b>	18.50mm Width 34.25mm Length Black Finish Quarter Panel & Rear Windshield Reveal Moulding Clips G.M. # 7730788	<b>50 Pcs.</b>		
<b>9899PK</b>	19.00mm Width 34.50mm Length Red Finish Windshield Reveal Moulding Clips G.M. # 9895598	<b>50 Pcs.</b>		
<b>9548PK</b>	19.50mm Width 23.50mm Length Silver Finish Windshield & Rear Window Reveal Moulding Clips G.M. # 20603072, 9606232, 9662950	<b>100 Pcs.</b>		

## Retainers Moulding

<b>10545PK</b>	6.00 x 16.00mm Hole Size 11mm Width 14mm Length White Nylon Front & Rear Bumper Moulding Clips G.M. # 11561857	<b>25 Pcs.</b>		
<b>10804PK</b>	15/64" (6mm) Hole Size 12.50mm Width 28mm Length Yellow Nylon With Sealer Side Window Reveal Moulding Clips GM # 11570512	<b>10 Pcs.</b>		
<b>10679PK</b>	6.50 x 12.50mm Hole Size Black Nylon Fascia Trim Cover Twist Lock Retainers G.M. # 11610049	<b>25 Pcs.</b>		

# General Motors

## Retainers Moulding

<b>10802PK</b>	9/32" (7mm) Hole Size 13mm Stem Length 7.50 x 11.00mm Top Head Size Green Nylon With Sealer Fender Moulding Clips G.M. # 11569920	<b>10 Pcs.</b>		
<b>10823PK</b>	9/32" (7mm) Hole Size 13mm Stem Length 13.00 x 30.00mm Top Head Size White Nylon With Sealer Roof Rail Moulding Clips G.M. # 11569918	<b>15 Pcs.</b>		
<b>15311PK</b>	5/16" (8mm) Hole Size 8mm Stem Length 3.50 x 8.00mm Top Head Size White Nylon Door & Rocker Panel Moulding Clips G.M. # 10287547	<b>25 Pcs.</b>		
<b>12026PK</b>	5/16" (8mm) Hole Size 10mm Stem Length 11.00 x 15.00mm Top Head Size White Nylon With Sealer Fender & Bumper Moulding Clips G.M. # 94530742	<b>15 Pcs.</b>		
<b>12921PK</b>	5/16" (8mm) Hole Size 11mm Stem Length 13mm Top Head Diameter Blue Nylon Garnish Moulding Retainers G.M. # 88970345 Toyota # 90467-10167	<b>25 Pcs.</b>		
<b>12808PK</b>	5/16" (8mm) Hole Size 13mm Stem Length 8.00 x 18.00mm Top Head Diameter White Nylon With Sealer Moulding Clips G.M. # 11611375	<b>15 Pcs.</b>		
<b>13316PK</b>	5/16" (8mm) Hole Size 9/16" Stem Length 11/16 x 1 5/16" Head Size Black Nylon Rocker Moulding Clips G.M. # 10431524	<b>15 Pcs.</b>		
<b>9969PK</b>	5/16" (8mm) Hole Size 11/16" Stem Length 15/32 x 1 5/16" Head Size Black Nylon Rocker Panel Moulding Clips G.M. # 10437565, 10352803	<b>10 Pcs.</b>		

# General Motors

## Retainers Moulding

<b>12182PK</b>	5/16" (8mm) Hole Size 11/16" Stem Length 15/32 x 1 9/32" Head Size Maroon Nylon Rocker Moulding Clips G.M. 10352804	<b>10 Pcs.</b>		
<b>9967PK</b>	5/16" (8mm) Hole Size 11/16" Stem Length 11/16 x 1 5/16" Head Size Black Nylon Rocker Panel Moulding Clips G.M. # 10352799	<b>15 Pcs.</b>		
<b>13420PK</b>	5/16" (8mm) Hole Size 11/16" Stem Length 11/16 x 1 5/16" Head Size White Nylon Rocker Panel Moulding Clips G.M. # 10352809, 10426887, 10431503	<b>15 Pcs.</b>		
<b>10488PK</b>	5/16" (8mm) Hole Size 11/16" Stem Length 11/16 x 1 5/16" Head Size Tan Nylon Rocker Panel Moulding Clips G.M. # 10431523	<b>15 Pcs.</b>		
<b>10489PK</b>	5/16" (8mm) Hole Size 11/16" Stem Length 11/16 x 1 5/16" Head Size Gray Nylon Rocker Panel Moulding Clips G.M. # 10352797	<b>15 Pcs.</b>		
<b>10487PK</b>	5/16" (8mm) Hole Size 11/16" Stem Length 11/16 x 1 5/16" Head Size Red Nylon Rocker Panel Moulding Clips G.M. # 10431526, 10353825	<b>15 Pcs.</b>		

18

# General Motors













## Retainers Moulding

<b>10484PK</b>	5/16" (8mm) Hole Size 11/16" Stem Length 11/16 x 1 5/16" Head Size Dark Red Nylon Rocker Panel Moulding Clips G.M. # 10352800	<b>15 Pcs.</b>		
<b>10803PK</b>	5/16" (8mm) Hole Size 20mm Stem Length 6.00 x 11.00mm Top Head Size White Nylon With Sealer Side Window Moulding Clips G.M. # 11610522, 10383817	<b>10 Pcs.</b>		
<b>10805PK</b>	5/16" (8mm) Hole Size 20mm Stem Length 10.00 x 17.00mm Top Head Size Green Nylon With Sealer Window Reveal Moulding Clips GM # 11569697	<b>5 Pcs.</b>		
<b>18824PK</b>	11/32" (9mm) Hole Size 9.50mm Stem Length 16mm Top Head Size Black Nylon With Sealer Tail Lamp Retainers G.M. # 11571063	<b>25 Pcs.</b>		
<b>10750PK</b>	23/64" (9mm) Hole Size 10mm Stem Length 10.00 x 13.00mm Top Head Diameter Yellow Nylon Fender Flare Retainers G.M. # 88969790 Toyota # 75867-21010	<b>25 Pcs.</b>		
<b>16093PK</b>	23/64" (9mm) Hole Size 10mm Stem Length 12.00 x 20.00mm Green Nylon With Sealer Moulding Retainers G.M. # 11547210	<b>10 Pcs.</b>		
<b>12029PK</b>	23/64" (9mm) Hole Size 10mm Stem Length 12.00 x 29.00mm Head Size Green Nylon Rocker Moulding Clips G.M. # 25922739	<b>25 Pcs.</b>		
<b>12600PK</b>	23/64" (9mm) Hole Size 11mm Stem Length 12.00 x 20.00mm Top Head Size White Nylon With Sealer Body Side & Trim Moulding Retainer GM # 11547581	<b>25 Pcs.</b>		

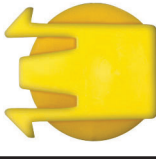
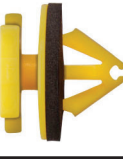
18

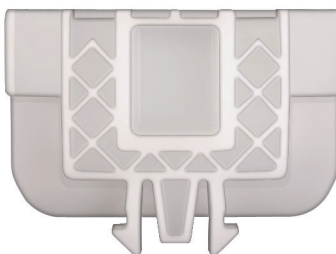
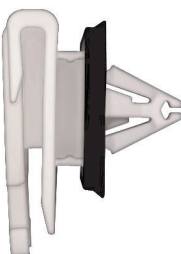
# General Motors

## Retainers Moulding

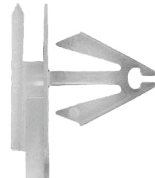
<b>12040PK</b>	23/64" (9mm) Hole Size 11mm Stem Length 12.00 x 20.00mm Head Size Gray Nylon With Sealer Rocker Moulding Retainers Chrysler # 68172491AA G.M. # 11571175	<b>15 Pcs.</b>		
<b>10480PK</b>	23/64" (9mm) Hole Size 11mm Stem Length 12.00 x 20.00mm Top Head Size White Nylon Body Side Moulding Clips G.M. # 15127746	<b>15 Pcs.</b>		
<b>12412PK</b>	23/64" (9mm) Hole Size 11mm Stem Length 12.00 x 20.00mm Top Head Size White Nylon With Sealer Rocker Panel Moulding Clips G.M. # 11562250	<b>15 Pcs.</b>		
<b>9667PK</b>	23/64" (9mm) Hole Size 11mm Stem Length 12.50 x 20.00mm Top Head Size Yellow Nylon With Sealer Lower Door Moulding Retainers G.M. # 11570847	<b>10 Pcs.</b>		
<b>18263PK</b>	23/64" (9mm) Hole Size 11mm Stem Length 12.50 x 23.00mm Top Head Size White Nylon Tailgate Cover Retainer G.M. # 11611626	<b>25 Pcs.</b>		
<b>16397PK</b>	23/64" (9mm) Hole Size 12mm Stem Length 33.00 x 45.50mm Top Head White Nylon With Sealer Rocker Moulding Retainers G.M. # 11601845	<b>10 Pcs.</b>		
<b>12908PK</b>	23/64" (9mm) Hole Size 14mm Stem Length 9.00 x 20.00mm Top Head Size Yellow Nylon With Sealer Rocker Moulding Clips G.M. # 11546635, 11612122	<b>10 Pcs.</b>		
<b>10357PK</b>	23/64" (9mm) Hole Size 14mm Stem Length 12.00 x 20.00mm Top Head Size White Nylon Rocker Panel Moulding Clips G.M. # 10323057	<b>15 Pcs.</b>		

18

# General Motors











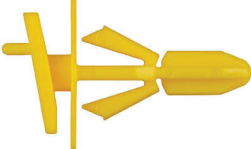

## Retainers Moulding

<b>13227PK</b>	25/64" (9mm) Hole Size 14mm Stem Length 13mm Top Head Diameter Black Nylon With Sealer Tailgate Moulding Retainers G.M. # 22691056	<b>15 Pcs.</b>		
<b>10485PK</b>	23/64" (9mm) Hole Size 14mm Stem Length 14.00 x 20.00mm Top Head Size Yellow Nylon With Sealer Rocker Panel Moulding Clips G.M. # 5480852	<b>10 Pcs.</b>		
<b>10826PK</b>	23/64" (9mm) Hole Size 15mm Stem Length 12.00 x 20.00mm Top Head Size Black Nylon Rocker Moulding Clips Saturn	<b>15 Pcs.</b>		
<b>10481PK</b>	23/64" (9mm) Hole Size 15mm Stem Length 12.00 x 20.00mm Top Head Size Gray Nylon With Sealer Windshield Pillar Moulding Clips G.M. # 15288146, 15893516	<b>15 Pcs.</b>		
<b>12272PK</b>	23/64" (9mm) Hole Size 16mm Stem Length 12.00 x 20.00mm Top Head Size Gray Nylon With Sealer Moulding Retainers G.M. 11609923, 11609740	<b>15 Pcs.</b>		
<b>15870PK</b>	23/64" (9mm) Hole Size 16mm Stem Length 12.00 x 20.00mm Top Head Size Blue Nylon With Sealer Rocker Moulding Retainers G.M. # 11547211	<b>10 Pcs.</b>		
<b>13515PK</b>	23/64" (9mm) Hole Size 16mm Stem Length 16.00 x 26.00mm Top Head Size White Nylon Moulding Retainers G.M. # 11588818	<b>10 Pcs.</b>		
<b>18236PK</b>	23/64" (9mm) Hole Size 20mm Stem Length 9.50 x 20.00mm Top Head Size Yellow Nylon With Sealer Rocker Moulding Clips G.M. # 15864780, 11569921	<b>10 Pcs.</b>		

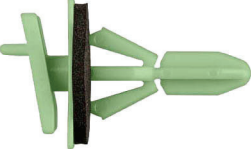
18

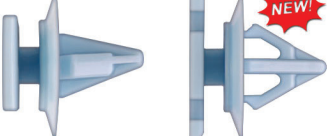
# General Motors



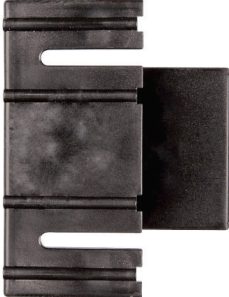
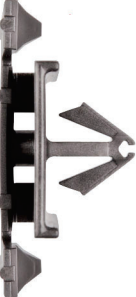



## Retainers Moulding

<b>18304PK</b>	11.50 x 21.00mm Head Size 11mm Stem Length 17mm Over all Height Black Nylon Moulding Retainers G.M. # 11547341	<b>50 Pcs.</b>		
<b>18803PK</b>	12 x 10mm Top Head Size 21mm Over all Length 11mm Stem Size Yellow Nylon Front Bumper Retainers G.M. # 11603057	<b>25 Pcs.</b>		
<b>12030PK</b>	23/64" (9mm) Hole Size 24mm Stem Length 12.00 x 16.00mm Head Size Yellow Nylon Door Moulding Clips G.M. # 25774893	<b>15 Pcs.</b>		
<b>12032PK</b>	23/64" (9mm) Hole Size 24mm Stem Length 12.00 x 16.00mm Head Size Green Nylon With Sealer Rocker Moulding Clips G.M. # 25775903	<b>10 Pcs.</b>		
<b>18896PK</b>	23/64" (9.10mm) Hole Size 14mm Stem Length 19mm Flange Diameter Blue Nylon Front Wheel Moulding Retainers G.M.# 86779331	<b>25 Pcs.</b>		
<b>15008PK</b>	3/8" (9.50mm) Hole Size 3/8" Stem Length 9/16 x 3/4" Head Size Yellow Nylon Door Trim Moulding Retainers G.M. # 25718851	<b>25 Pcs.</b>		
<b>15018PK</b>	3/8" (9.50mm) Hole Size 7/16" Stem Length 9/16 x 23/32" Head Size White Nylon Rocker Panel Moulding Clips G.M. # 15236894	<b>15 Pcs.</b>		
<b>15298PK</b>	3/8" (9.50mm) Hole Size 7/16" Stem Length 3/4 x 1 9/16" Top Head Size Black Nylon Rocker Panel Moulding Retainers G.M. # 15236893	<b>15 Pcs.</b>		

18

# General Motors

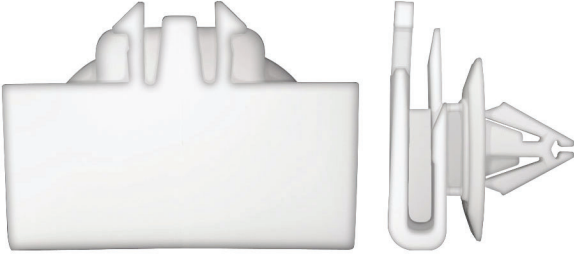
## Retainers Moulding

<b>18895PK</b>	23/64" (9.10mm) Hole Size 14mm Stem Length 19mm Flange Diameter Orange Nylon Body Side Moulding Retainers G.M. # 86779330	<b>25 Pcs.</b>	
<b>13106PK</b>	3/8" (9.50mm) Hole Size 9/16" Stem Length 9/16 x 25/32" Head Size Blue Nylon Rocker Panel Moulding Clips G.M. # 25742293	<b>15 Pcs.</b>	
<b>10680PK</b>	3/8" (9.50mm) Hole Size 9/16" Stem Length 9/16 x 13/16" Top Head Size White Nylon Rocker & Grille Moulding Clips G.M. # 25724529	<b>15 Pcs.</b>	
<b>12109PK</b>	3/8" (9.50mm) Hole Size 9/16" Stem Length 3/4 x 1 1/32" Head Size White Nylon Rocker Panel Moulding Clips G.M. # 11589176	<b>15 Pcs.</b>	
<b>13039PK</b>	3/8" (9.50mm) Hole Size 15mm Stem Length 12.00 x 20.00mm Head Diameter White Nylon Fender Moulding Clips With Sealer G.M. 11518988	<b>15 Pcs.</b>	
<b>16348PK</b>	9.00 x 20.00mm Hole Size 15mm Stem Length 33.00 x 45.00mm Top Head Size White Nylon Rocker Panel Mldg Retainers G.M. # 11549137	<b>10 Pcs.</b>	
<b>17929PK</b>	25/64" (10mm) Hole Size 14mm Stem Length 13mm Top Head Diameter White Nylon Trim Moulding Retainers G.M. # 11546850	<b>50 Pcs.</b>	
<b>10827PK</b>	25/64" (10mm) Hole Size 15mm Stem Length 12.00 x 20.00mm Top Head Size White Nylon Rocker Moulding Clips G.M. # 11562563	<b>15 Pcs.</b>	

# General Motors

## Retainers Moulding

<b>10482PK</b>	25/64" (10mm) Hole Size 15mm Stem Length 16.00 x 38.00mm Top Head Size Green Nylon Body Side Moulding Clips G.M. # 15116576, 15282120	<b>15 Pcs.</b>		
<b>12909PK</b>	25/64" (10mm) Hole Size 15mm Stem Length 22.00 x 45.00mm Top Head Size White Nylon With Sealer Moulding Clips G.M. # 11611435	<b>10 Pcs.</b>		
<b>13208PK</b>	25/64" (10mm) Hole Size 15mm Stem Length 18.00 x 26.00mm Top Head Size Black Nylon Moulding Retainers G.M. # 11561329	<b>10 Pcs.</b>		
<b>16087PK</b>	25/64" (10mm) Hole Size 17mm Stem Length 22.00 x 46.00mm Head Size Green Nylon Rocker Moulding Retainers G.M. # 25744385	<b>15 Pcs.</b>		
<b>10059PK</b>	7/16" (11mm) Hole Size 17/32" Stem Length 7/8" Width 2" Length Gray Nylon Rocker Panel Moulding Clips G.M. # 25722671	<b>10 Pcs.</b>		
<b>9914PK</b>	7/16" (11mm) Hole Size 9/16" Stem Length 15/32 x 13/16" Top Head Size Green Nylon Rocker Panel Moulding Clips G.M. # 10423553	<b>15 Pcs.</b>		
<b>9991PK</b>	7/16" (11mm) Hole Size 9/16" Stem Length 15/32 x 25/32" Top Head Size Natural Nylon With Sealer Rear Wheel Opening Moulding Clips G.M. # 10297368	<b>10 Pcs.</b>		
<b>12512PK</b>	7/16" (11mm) Hole Size 9/16" Stem Length 1/2 x 9/16" Top Head Size White Nylon With Sealer Rocker Panel Moulding Clips G.M. # 10442914	<b>15 Pcs.</b>		

# General Motors

## Retainers Moulding

<b>10127PK</b>	7/16" (11mm) Hole Size 9/16" Stem Length 9/16 x 3/4" Top Head Size Gray Nylon Rocker Panel Moulding Clips G.M. # 25693852	<b>25 Pcs.</b>		
<b>10129PK</b>	7/16" (11mm) Hole Size 9/16" Stem Length 9/16 x 13/16" Top Head Size Natural Nylon With Sealer Rocker Panel Moulding Clips G.M. # 11518357	<b>15 Pcs.</b>		
<b>9992PK</b>	7/16" (11mm) Hole Size 9/16" Stem Length 9/16 x 13/16" Top Head Size Black Nylon Front Fender With Opening Moulding Clips G.M. # 10242298	<b>25 Pcs.</b>		
<b>9915PK</b>	7/16" (11mm) Hole Size 9/16" Stem Length 9/16 x 13/16" Top Head Size White Nylon Rocker Panel Moulding Clips G.M. # 10443956	<b>15 Pcs.</b>		
<b>10429PK</b>	7/16" (11mm) Hole Size 9/16" Stem Length 9/16 x 1 1/8" Top Head Size Gray Nylon Rocker Panel Moulding Clips G.M. # 15221959	<b>15 Pcs.</b>		
<b>9990PK</b>	7/16" (11mm) Hole Size 9/16" Stem Length 19/32 x 25/32" Top Head Size Yellow Nylon With Sealer Rear Wheel Opening Moulding Clips G.M. # 10297371	<b>15 Pcs.</b>		
<b>10056PK</b>	7/16" (11mm) Hole Size 19/32" Stem Length 3/4 x 1" Top Head Size White Nylon Rocker Panel Moulding Clips G.M. # 22603384	<b>15 Pcs.</b>		

18

# General Motors

## Retainers Moulding

**15299PK** 7/16" (11mm) Hole Size  
21/32" Stem Length  
3/4 x 1 9/16" Head Size  
White Nylon  
Rocker Moulding Retainers  
G.M. # 10384814

15 Pcs.

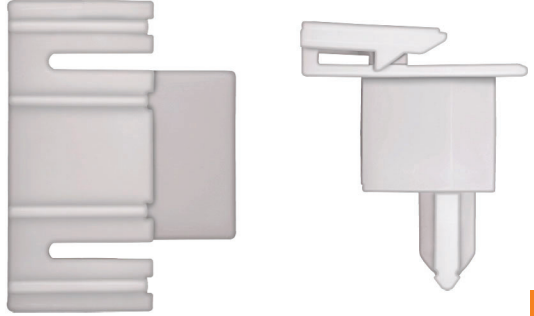

**10128PK** 7/16" (11mm) Hole Size  
21/32" Stem Length  
7/8" Width  
2" Length  
Gray Nylon  
Rocker Moulding Clips  
G.M. # 25648693

10 Pcs.

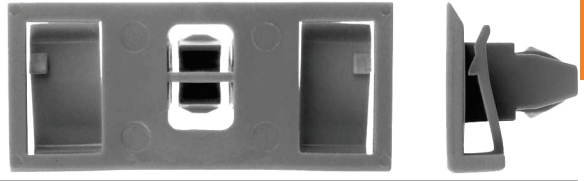

**15154PK** 7/16" (11mm) Hole Size  
1 3/8" Stem Length  
15/32 x 27/32" Top Head Size  
Yellow Nylon W/Sealer  
Rocker Panel Moulding Clips  
G.M. # 11589244, 11569973

10 Pcs.

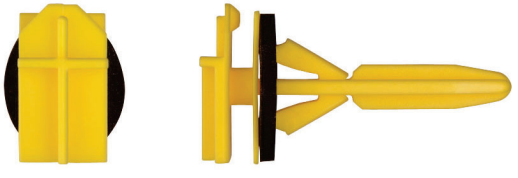

**10058PK** 7/16" (11mm) Hole Size  
1 1/4" Stem Length  
1 1/16 x 1 1/2" Top Head Size  
Gray Nylon  
Rocker Panel Moulding Clips  
G.M. # 10431761, 10411395

15 Pcs.

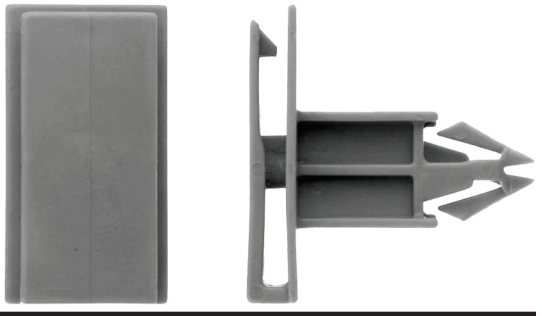

**13235PK** 7/16" (11mm) Hole Size  
33mm Stem Length  
18.00 x 38.00mm Top Head Size  
Black Nylon  
Rocker, Pillar & Floor Moulding Clips  
G.M. # 10363352

15 Pcs.

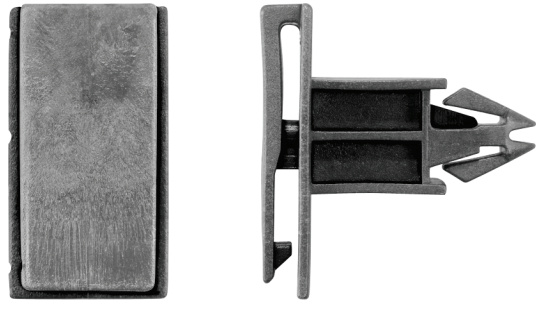

**10651PK** 43/64" (17mm) Hole Size  
12mm Stem Length  
20.00 x 30.00mm Top Head Size  
Black Nylon With Sealer  
Rocker Panel Moulding Clips  
G.M. # 11561491, 15872008



















10 Pcs.

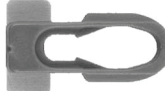

18

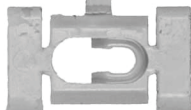







# General Motors

## Retainers Moulding

<b>15155PK</b>	<p>7/8" (22mm) Hole Size          10mm Stem Length          32mm Head Diameter          Black Nylon          Rocker Moulding Retainers          G.M. # 88970495, 88973654          Toyota # 76924-52021, 76924-02010,          76924-02020</p>	<b>25 Pcs.</b>		
<b>12656PK</b>	<p>#8 (4.20mm) Screw Size          13mm Width          22mm Length          13.50 x 20.50mm Head Size          Zinc Finish          Garnish Moulding Clips          G.M. # 11609651</p>	<b>15 Pcs.</b>		
<b>9853PK</b>	<p>7/16" Width          25/32" Length          Natural Nylon          Quarter Panel and Reveal Moulding Clips          G.M. # 7731589</p>	<b>100 Pcs.</b>		
<b>1159PK</b>	<p>7/16" Width          31/32" Length          White Nylon          Quarter Belt          Reveal Moulding Clips          G.M. # 20199675</p>	<b>50 Pcs.</b>		
<b>9895PK</b>	<p>31/64" Width          57/64" Length          White Nylon          Door, Quarter Panel &amp;          Rear End Moulding Clips          G.M. # 8799350</p>	<b>50 Pcs.</b>		
<b>12389PK</b>	<p>1/2" Width          5/8" Overall Length          Zinc Finish          Garnish Moulding Retainers          G.M. # 15748479</p>	<b>25 Pcs.</b>		
<b>987PK</b>	<p>33/64" Width          27/32" Length          Gray Nylon          Door &amp; Body Side Moulding Clips          G.M. # 9838109</p>	<b>100 Pcs.</b>		
<b>1172PK</b>	<p>9/16" Width          61/64" Length          White Nylon          Quarter Belt          Reveal Moulding Clips          G.M. # 20175051, 15633873</p>	<b>50 Pcs.</b>		
<b>12843PK</b>	<p>7/8" Width          2" Length          Black Nylon          Rocker Panel Molding Clips          G.M. # 25691949, 25704001</p>	<b>10 Pcs.</b>		











# General Motors

## Retainers Moulding

<p><b>13100PK</b></p> <p>26mm Width 43mm Length Light Brown Nylon Belt Molding Clips G.M. # 11547339</p>	<p>15 Pcs.</p>		
<p><b>12133PK</b></p> <p>Windshield Black Nylon Upper Garnish Moulding Clips G.M. # 20058837</p>	<p>10 Pcs.</p>	 <p style="text-align: center;"><b>Not Actual Size</b></p>	
<p><b>12805PK</b></p> <p>11.50 x 21.00mm Head Size 11mm Stem Length 17mm Overall Height White Nylon Moulding Clips Chrysler # 68225214-AA G.M. # 11547341</p>	<p>50 Pcs.</p>		
<p><b>13519PK</b></p> <p>10mm Stem Length 17.00 x 24.00mm Top Head Red Nylon With Sealer &amp; Metal Reinforced Door Sill Plate Retainers G.M. # 11547024</p>	<p>10 Pcs.</p>		
<p><b>14995PK</b></p> <p>10mm Stem Length 17.00 x 24.00mm Top Head Size Blue Nylon With Sealer Interior Trim &amp; Windshield Pillar Moulding Retainers G.M. # 11611367</p>	<p>10 Pcs.</p>		
<p><b>17588PK</b></p> <p>10mm Stem Length 17.00 x 24.00mm Top Head Size Red Nylon With Metal Reinforced Interior Trim &amp; Windshield Garnish Moulding Retainers G.M. # 11547026</p>	<p>10 Pcs.</p>		

# General Motors

## Retainers Moulding

<b>13104PK</b>	10mm Stem Length 17.00 x 24.00mm Top Head Size Blue Nylon With Metal Reinforced Interior Trim & Windshield Pillar Moulding Retainers G.M. # 11611623	<b>10 Pcs.</b>		
<b>18095PK</b>	11mm Stem Length 17.00 x 20.00mm Top Head Size Blue Nylon With Metal Reinforced Windshield Pillar, Interior & Trunk Trim Moulding Retainers G.M. # 24405740	<b>15 Pcs.</b>		
<b>18165PK</b>	12mm Stem Length 17.00 x 20.00mm Top Head Size Black Nylon With Metal Reinforced Windshield Pillar, Interior Moulding Retainers G.M. # 24405739	<b>15 Pcs.</b>		
<b>18119PK</b>	19mm Stem Length 19mm Overall Height 17.50 x 25.00mm Head Size Black Finish Grille Assembly Retainer G.M. # 11546500	<b>10 Pcs.</b>		
<b>16310PK</b>	8mm Width 15mm Height White Nylon Quarter Panel & Exterior Trim Moulding Clips Ford # W714972-S300 GM # 94748652	<b>25 Pcs.</b>		

## Retainers Universal Moulding

<b>308PK</b>	3/8" Hole Size Front & Rear Door Universal Moulding Clips G.M. # 4759145, 4761842, 4779348	<b>50 Pcs.</b>		
--------------	---	----------------	--	---

# General Motors

## Retainers Universal Moulding

**2194PK**

10-24 x 3/4" Screw Size  
3/4 x 2 1/2" Plate Size  
Breaks Off In 1/16"  
Bright Zinc Finish  
Moulding Tee Bolts

25 Pcs.

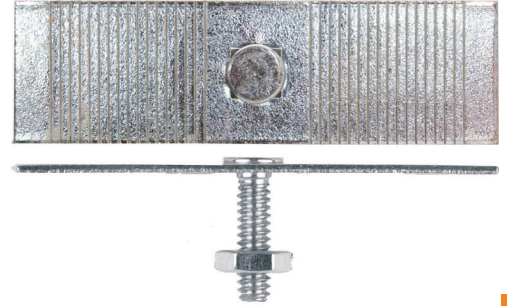

**347PK**

10-24 x 3/4" Screw Size  
11/32 x 23/32" Plate Size  
Universal  
Moulding Clips  
Chrysler # 1624705, 6010093  
G.M. # 4689929, 4778814

50 Pcs.



**9879PK**

10-24 x 3/4" Screw Size  
1/2 x 1 1/16" Plate Size  
Universal Moulding Clips  
Chrysler # 1560058, 6010029  
Ford # 358560  
G.M. # 568792, 574355, 1165051

25 Pcs.



**345PK**

10-24 x 3/4" Screw Size  
1/2 x 1 25/64" Plate Size  
Universal Moulding Clips  
Chrysler # 6000705, 6013029  
G.M. # 3722635

50 Pcs.



**344PK**

10-24 x 3/4" Screw Size  
9/16 x 1 25/32" Plate Size  
Universal  
Moulding Clips  
Chrysler # 1758099, 6000720, 6010046  
G.M. # 3744999

50 Pcs.

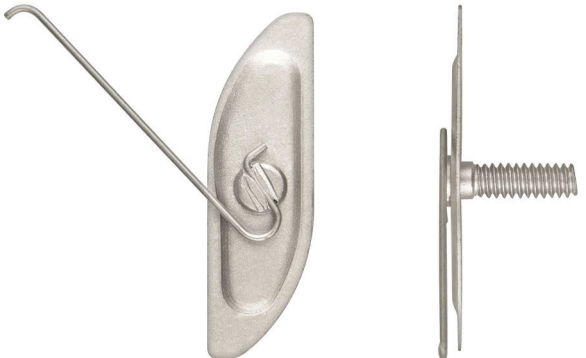

18

# General Motors

## Retainers Universal Moulding

**9711PK**

10-24 x 3/4" Screw Size  
11/16 x 2 17/32" Plate Size  
Commercial Zinc Finish  
Universal Moulding Clips  
G.M. # 4676189

15 Pcs.

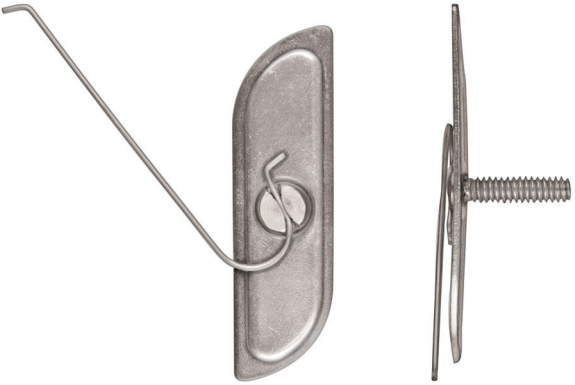

**315PK**

13/16 x 2 1/8" Plate Size  
Universal  
Moulding Clips

25 Pcs.



18