













# Ford



## Nuts Barrel

|               |  |                 |  |   |
|---------------|--|-----------------|--|---|
| <b>709PK</b>  | 1/8" Stud Size<br>3/16" Hole Size<br>Black Finish<br>Barrel Nuts<br>Ford # 375890-S100                               | <b>100 Pcs.</b> |  |  |
| <b>710PK</b>  | 1/8" Stud Size<br>1/4" Hole Size<br>Black Finish<br>Barrel Nuts<br>Ford # 375480-S100, 3783794                       | <b>100 Pcs.</b> |  |  |
| <b>9878PK</b> | 3/16" Stud Size<br>17/64" Hole Size<br>Black Nylon<br>Barrel Nuts<br>Ford # D7VY-6050074-A<br>Renault # 8934-201-767 | <b>100 Pcs.</b> |  |  |
| <b>9941PK</b> | 1/4" Stud Size<br>9/32" Hole Size<br>Black Finish<br>Barrel Nuts<br>Ford # 354341-S                                  | <b>100 Pcs.</b> |  |  |



## Nuts Push On Type Threaded Stud Metric

|                |   |                 |   |   |
|----------------|---|-----------------|---|---|
| <b>1621PK</b>  | 6-1.00mm Screw Size<br>17mm Outside Diameter Flange<br>Zinc Plated<br>Push On Type Retainers<br>Chrysler # 6501178, 6501192<br>Ford # N801192S36<br>G.M. # 11503736, 11609738, 14093869 | <b>100 Pcs.</b> |  |   |
| <b>17093PK</b> | 16mm Screw Size<br>35mm Outside Diameter Flange<br>Zinc Finish<br>Push On Type Retainers<br>Ford # W721197-S437M  | <b>25 Pcs.</b>  |  | <br><b>NEW!</b> |

## Nuts Emblem

|                |  |                |  |   |
|----------------|--|----------------|--|---|
| <b>18451PK</b> | 5mm Stud Size<br>10mm Hex Size<br>15mm Flange Diameter<br>Zinc Finish<br>Locking Teeth<br>Emblem Nuts<br>Ford # W706675-S439 | <b>50 Pcs.</b> |  |  |
|----------------|--|----------------|--|---|

## Nuts Thread Cutting Metric

|               |  |                |  |   |
|---------------|--|----------------|--|---|
| <b>1041PK</b> | 5mm Stud Size<br>10mm Hex Size<br>15mm Flange Diameter<br>Black Finish<br>Thread Cutting Nuts<br>Ford # W707501-S300<br>G.M. # 11501835, 11508900, 11510062,<br>11501932 | <b>50 Pcs.</b> |  |  |
|---------------|--|----------------|--|---|

# Ford

## Nuts Hex Loose Washer Standard

**17921PK** 1/4 - 20 Screw Size  
7/16" Hex Size  
5/8" Outside Diameter Loose Washer  
Yellow Zinc Finish  
Hex Nuts  
G.M. # 3866846  
Ford # 385400, 45334  
Chrysler # 6023204, 6025004, 6033560

25 Pcs.



## Nuts Hex Loose Washer Metric

**12053PK** 5-.80mm Thread Size  
8mm Hex Size  
10mm Outside Diameter  
Loose Washer  
Yellow Zinc Finish  
Metric Hex Nuts  
Ford # N802775-S36

50 Pcs.



**1639PK** 5-.80mm Screw Size  
10mm Hex Size  
15mm Outside Diameter Loose Washer  
Black Finish  
Metric Hex Nuts  
AMC # 4200408  
Ford # N621903-S61, N621903-S2  
G.M. # 11504614

50 Pcs.



**12055PK** 6-1.00mm Screw Size  
11mm Hex Size  
24mm Outside Diameter  
Loose Washer  
Yellow Zinc Finish  
Metric Hex Nuts  
Ford # N621907, N621907-S55

25 Pcs.



**5916XPX** 8-1.25mm Screw Size  
13mm Hex Size  
24mm Outside Diameter  
Loose Barbed Washer  
Black Finish  
Metric Hex Nuts  
Ford # N621940-S424  
G.M. # 11503695, 11506117, 11516780,  
11500401

25 Pcs.



**11909PK** 10-1.50mm Screw Size  
15mm Hex Size  
24mm Outside Diameter Loose Washer  
Black Finish  
Metric Hex Nuts  
Chrysler # 6100053  
Ford # N621942-S301, N621942-S441,  
N621942-S2

25 Pcs.



## Nuts Nylon







**18840PK** 6mm Screw Size  
10mm Hex Size  
15mm Height  
30mm Flange Diameter  
Black Nylon  
Splash Shield Nuts  
Ford # W719534-S300

25 Pcs.

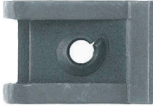

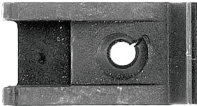

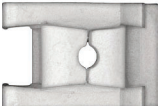



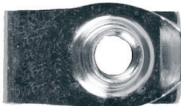

# Ford

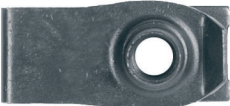
## Nuts Speed Type "U" for Sheet Metal Screws

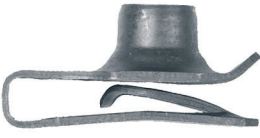

|                |   |                 |  |   |
|----------------|---|-----------------|--|---|
| <b>1350PK</b>  | #8 (4.20mm) Screw Size<br>3/8" Center of Hole to Edge<br>.020 - .150" Panel Range<br>Black Finish<br>Speed Type "U" Nuts<br>Ford # 381818-S2, 15650655<br>G.M. # 9424837, 9431530, 15650655 | <b>100 Pcs.</b> |  |  |
| <b>5750PK</b>  | #8 (4.20mm) Screw Size<br>5/8" Center of Hole to Edge<br>.025 - .150" Panel Range<br>Black Finish<br>Speed Type "U" Nuts<br>Ford # 381863-S2<br>G.M. # 9440178, 9433155, 11504531           | <b>100 Pcs.</b> |  |  |
| <b>18795PK</b> | #8 (4.20-1.41mm) Screw Size<br>0.50 - 1.80mm Panel Range<br>7.92mm Center of Hole to Edge<br>Zinc Finish Bumper Cover &<br>Wheel Moulding U-Nuts<br>Ford # W704277-S496                     | <b>25 Pcs.</b>  |  |  |

## Nuts Extruded Type "U" Standard

|               |   |                |  |   |
|---------------|---|----------------|--|---|
| <b>2969PK</b> | 1/4-20 Screw Size<br>17/32" Center of Hole to Edge<br>.010 - .165" Panel Range<br>Black Finish<br>Extruded "U" Nuts<br>Ford # 45263-S2<br>G.M. # 1494252, 1480627 | <b>25 Pcs.</b> |    |    |
| <b>5480PK</b> | 1/4-20 Screw Size<br>25/32" Center of Hole to Edge<br>.010 - .165" Panel Range<br>Black Finish<br>Extruded "U" Nuts<br>Ford # 45267<br>G.M. # 1494257             | <b>25 Pcs.</b> |   |   |
| <b>1836PK</b> | 5/16-18 Screw Size<br>27/32" Center of Hole to Edge<br>.010 - .170" Panel Range<br>Black Finish<br>Extruded "U" Nuts<br>Ford # 379831-S<br>G.M. # 1494258         | <b>25 Pcs.</b> |  |  |
| <b>5412PK</b> | 3/8-16 Screw Size<br>3/4" Center of Hole to Edge<br>.035 - .205" Panel Range<br>Black Finish<br>Extruded "U" Nuts<br>Ford # 45265-S2<br>G.M. # 1494254, 12337873  | <b>25 Pcs.</b> |  |  |
| <b>5466PK</b> | 3/8-16 Screw Size<br>1 1/8" Center of Hole to Edge<br>.035 - .220" Panel Range<br>Black Finish<br>Extruded "U" Nuts<br>Ford # 45269, 45269-S                      | <b>25 Pcs.</b> |  |  |

Not Actual Size













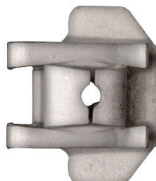



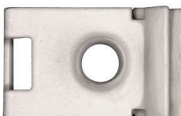

## Nuts Extruded Type "U" Metric

|                |   |                |  |   |
|----------------|---|----------------|--|---|
| <b>10726PK</b> | #8 (4.20-1.41mm) Screw Size<br>10mm Center of Hole to Edge<br>.50 - 2.00mm Panel Range<br>Zinc Organic Prevailing Torque<br>Extruded "U" Nuts<br>Ford # W707291-S439<br>G.M. # 11516397 | <b>50 Pcs.</b> |  |  |
|----------------|---|----------------|--|---|

19







# Ford

## Nuts Extruded Type "U" Metric

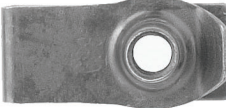





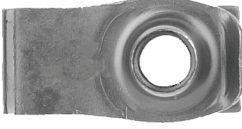
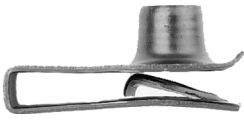



|                |  |                |  |   |
|----------------|--|----------------|--|---|
| <b>10795PK</b> | #8 (4.20-1.41mm) Screw Size<br>9.50mm Center of Hole to Edge<br>.65 - 3.80mm Panel Range<br>Zinc Organic Prevailing Torque<br>Extruded "U" Nuts<br>G.M. # 11513599<br>Ford # W704823-S439                                | <b>25 Pcs.</b> |   |    |
| <b>11981PK</b> | #8 (4.20mm) Screw Size<br>9.50mm Center of Hole to Edge<br>1.80 - 3.50mm Panel Range<br>Zinc Finish<br>Metric "U" Nuts<br>Ford # W716567-S439  | <b>25 Pcs.</b> |    |    |
| <b>16076PK</b> | #8 (4.20mm) Screw Size<br>2.00 - 3.40mm Panel Range<br>9.50mm Center of Hole to Edge<br>Zinc Organic Finish<br>Metric "U" Nuts<br>Ford # W708991-S439  | <b>25 Pcs.</b> |   |    |
| <b>12893PK</b> | 5-.80mm Screw Size<br>11mm Center of Hole to Edge<br>.60 - 3.80mm Panel Range<br>Black Finish<br>Extruded "U" Nuts<br>Ford # N623331-S2, W520821-S439,<br>W520821-S426<br>G.M. # 11505596, 11500656                      | <b>50 Pcs.</b> |    |    |
| <b>16328PK</b> | 6-1.00mm Screw Size<br>12mm Center of Hole to Edge<br>.70 - 2.00mm Panel Range<br>Zinc Finish<br>Extruded Type "U" Nuts<br>Ford # W712324-S439   | <b>10 Pcs.</b> |   |   |
| <b>10836PK</b> | 6-1.00mm Screw Size<br>13.50mm Center of Hole to Edge<br>.80 - 4.00mm Panel Range<br>Black Phosphate Organic Finish<br>Prevailing Torque Extruded "U" Nuts<br>Chrysler # 6101308<br>Ford # N800854-S1<br>G.M. # 11509005 | <b>25 Pcs.</b> |  |  |
| <b>5596PK</b>  | 6-1.00mm Screw Size<br>13.50mm Center of Hole to Edge<br>.80 - 4.00mm Panel Range<br>Black Finish<br>Extruded "U" Nuts<br>Ford # N623332, N623332-S2,<br>N623332-S53, N623332-S100<br>G.M. # 11503957, 11503716, 1016937 | <b>25 Pcs.</b> |  |  |
| <b>9512PK</b>  | 6-1.00mm Screw Size<br>13.50mm Center of Hole to Edge<br>3.40 - 6.30mm Panel Range<br>Black Finish<br>Extruded "U" Nuts<br>Ford # N802331-S53<br>G.M. # 11504047   | <b>25 Pcs.</b> |  |  |
| <b>16471PK</b> | 6-1.00mm Screw Size<br>14.50mm Center of Hole to Edge<br>.50 - 2.30mm Panel Range<br>Zinc Organic<br>Extruded "U" Nuts<br>Ford # W705958-S439  | <b>10 Pcs.</b> |  |  |

# Ford

## Nuts Extruded Type "U" Metric

|                |   |                |  |   |
|----------------|---|----------------|--|---|
| <b>5650PK</b>  | 6-1.00mm Screw Size<br>19.50mm Center of Hole to Edge<br>1.00 - 2.50mm Panel Range<br>Black Finish<br>Extruded "U" Nuts<br>Ford # W520832-S424, W520832-S426<br>G.M. # 11503715, 11506099, 11508241                             | <b>25 Pcs.</b> |  |  |
| <b>16075PK</b> | 8-1.25mm Screw Size<br>14.50mm Center of Hole to Edge<br>.80 - 4.00mm Panel Range<br>Zinc Finish<br>Extruded "U" Nuts<br>Ford # W520823-S439, N800296-S439  | <b>15 Pcs.</b> |  |  |
| <b>5560PK</b>  | 8-1.25mm Screw Size<br>14.50mm Center of Hole to Edge<br>.80 - 4.00mm Panel Range<br>Black Finish<br>Extruded "U" Nuts<br>Chrysler # 6100042, 6101283<br>Ford # N623333-S2, N623333-S100<br>G.M. # 11500660, 11508925, 11502617 | <b>25 Pcs.</b> |  |  |
| <b>5557PK</b>  | 8-1.25mm Screw Size<br>20mm Center of Hole to Edge<br>.80 - 4.50mm Panel Range<br>Black Finish<br>Extruded "U" Nuts<br>Ford # N623343-S100<br>G.M. # 11500661, 11503317, 11516150   | <b>25 Pcs.</b> |  |  |













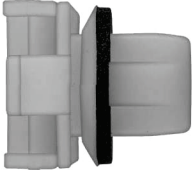



## Nuts Nylon

|                |   |                |  |   |
|----------------|---|----------------|--|---|
| <b>1227PK</b>  | #6 (3.50mm) Screw Size<br>8.50mm Stem Length<br>9.00 x 13.00mm Head Diameter<br>6.50 x 9.00mm Hole Size<br>Black Nylon Front Fender<br>Screw Grommets<br>Ford # N-800503S | <b>50 Pcs.</b> |   |               |
| <b>18794PK</b> | #8 (4.20mm) Screw Size<br>5mm Stem Length<br>12.75mm Head Diameter<br>7.87mm Square Hole Size<br>White Nylon<br>Grille Trim Screw Grommets<br>Ford # W711612-S300         | <b>25 Pcs.</b> |  |  <b>NEW!</b> |
| <b>10715PK</b> | #6 (3.50mm) Screw Size<br>16mm Stem Length<br>22.00 x 23.50mm Head Size<br>15mm Hole Size<br>Black Nylon Headlight<br>Screw Grommets<br>Ford # W712160-S300               | <b>15 Pcs.</b> |  |              |
| <b>1842PK</b>  | #8 (4.20mm) Screw Size<br>13/32" Stem Length<br>3/8" Head Diameter<br>1/4" Hole Size<br>Natural Nylon Grille<br>Screw Grommets<br>Ford # 379830-S                         | <b>50 Pcs.</b> |  |              |
| <b>12021PK</b> | #8 (4.20mm) Screw Size<br>13/32" Stem Length<br>3/8" Head Diameter<br>Black Nylon<br>Screw Grommets<br>Chrysler # 6033677<br>Ford # 379830-S, 383356-S                    | <b>25 Pcs.</b> |  |              |

19

# Ford

## Nuts Nylon



|                |  |                |   |   |
|----------------|--|----------------|---|---|
| <b>10556PK</b> | #8 (4.20mm) Screw Size<br>11mm Stem Length<br>10mm Head Diameter<br>6.70mm Hole Size<br>Natural Nylon Door Reveal<br>Screw Grommets<br>Ford # W710362<br>G.M. # 25647358   | <b>25 Pcs.</b> |    |    |
| <b>10384PK</b> | #8 (4.20mm) Screw Size<br>13mm Stem Length<br>23.20mm Square Head Diameter<br>10.00 x 14.00mm Hole Size<br>White Nylon<br>Cowl Vent Grommets<br>Ford # N807189-S100, N811353-S100  | <b>10 Pcs.</b> |     |    |
| <b>11994PK</b> | #8 (4.20mm) Screw Size<br>18mm Stem Length<br>11.50mm Head Diameter<br>Black Nylon Tail Light & Bumper<br>Screw Grommets<br>Ford # W708580-S300  | <b>25 Pcs.</b> |    |    |
| <b>10552PK</b> | #8 (4.20mm) Screw Size<br>18mm Stem Length<br>13.00 x 22.00mm Head Diameter<br>6.00 x 16.50mm Hole Size<br>Natural Nylon With Sealer<br>Back Glass Moulding & Interior Trim<br>Ford # W705590-S300, 713459-S300<br>G.M. # 25649667 | <b>15 Pcs.</b> |     |    |
| <b>16444PK</b> | 3/8" (9.40mm) Square Hole Size<br>12.50mm Stem Length<br>22mm Head Diameter<br>Natural Nylon<br>Front & Rear Door Panel<br>Screw Grommets<br>Ford # W711501-S300   | <b>25 Pcs.</b> |    |   |
| <b>2117PK</b>  | #8 (4.20mm) Screw Size<br>23mm Stem Length<br>10mm Head Diameter<br>7mm Hole Size<br>Natural Nylon<br>Screw Grommets<br>Ford # N804765-S   | <b>50 Pcs.</b> |  |  |
| <b>11229PK</b> | #10 (4.80mm) Screw Size<br>24mm Stem Length<br>16mm Head Diameter<br>10mm Hole Size<br>White Nylon With Sealer<br>Front Bumper Screw Grommets<br>Ford # W708319-S300   | <b>25 Pcs.</b> |  |  |
| <b>17908PK</b> | #10 (4.80mm) Screw Size<br>11mm Stem Length<br>20mm Head Diameter<br>11.50 x 7.50mm Hole Size<br>Red Nylon Radiator Grille<br>Screw Grommets<br>Ford # W702438-S300  | <b>25 Pcs.</b> |  |  |
| <b>9136PK</b>  | #12 (5.50mm) Screw Size<br>3/8" Square Hole<br>13/16" Stem Length<br>1/2" Head Diameter<br>Natural Nylon<br>Windshield Washer Reservoir Mounting<br>Screw Grommets<br>Ford # F5RZ-17K657-A   | <b>25 Pcs.</b> |  |  |

# Ford

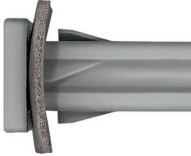
## Nuts Nylon





|                |  |                |  |   |
|----------------|--|----------------|--|---|
| <b>15839PK</b> | #12 (5.50mm) Screw Size<br>15mm Stem Length<br>16mm Head Diameter<br>10mm Hole Size<br>Natural Nylon Back Panel<br>Attachment Grommets<br>Ford # W700566-S300                                  | <b>25 Pcs.</b> |    |    |
| <b>16308PK</b> | 15/64" (6.00mm) Screw Size<br>23mm Stem Length<br>15mm Square Head Size<br>10mm Square Hole Size<br>Gray Nylon With Sealer<br>License Plate Grommets<br>Ford # W714172-S300                    | <b>15 Pcs</b>  |    |    |
| <b>9494PK</b>  | #14 (6.40mm) Screw Size<br>5/16" Stem Length<br>5/8 x 3/4" Head Diameter<br>3/8" Hole Size<br>Natural Nylon<br>License Plate Nuts<br>Ford # 380707-S   | <b>50 Pcs.</b> |    |    |
| <b>10461PK</b> | #14 (6.40mm) Screw Size<br>8mm Stem Length<br>16mm Head Diameter<br>9.50 x 10.00mm Hole Size<br>Black Nylon With Sealer<br>License Plate Nuts<br>Ford # N811478-S100                           | <b>15 Pcs.</b> |    |    |
| <b>9355PK</b>  | 13mm Head Diameter<br>9mm Stem Length<br>10mm Hole Size<br>Black Nylon<br>Grille & Side Marker Light<br>Screw Grommets<br>Ford # N807994-S, N811169S,<br>W704740-S300, W705550S300             | <b>50 Pcs.</b> |   |   |
| <b>9712PK</b>  | 13mm Head Diameter<br>9mm Stem Length<br>11mm Hole Size<br>White Nylon<br>Park & Turn Signal Grommets<br>Ford # N811169-S, W705550-S300<br>G.M. #10423331<br>Toyota # 90075-10801, 90189-06111 | <b>50 Pcs.</b> |  |  |
| <b>12024PK</b> | 13.00 x 17.00mm Head Diameter<br>10mm Stem Length<br>10.00 x 11.00mm Hole Size<br>Black Nylon<br>Tail Light Grommets<br>Ford # W711079-S300  | <b>25 Pcs.</b> |  |  |
| <b>11126PK</b> | 18.50 x 21.50mm Head Diameter<br>18mm Stem Length<br>9.50 x 21.50mm Hole Size<br>Black Nylon<br>Headlight & Tail Light Grommets<br>Ford # F50Y-14603-A   | <b>25 Pcs.</b> |  |  |

## Grommets

|                |  |                |  |   |
|----------------|--|----------------|--|---|
| <b>17832PK</b> | 9/32" (7mm) Hole Size<br>25mm Stem Length<br>21mm Head Diameter<br>Black Nylon<br>Rear Bumper Cover Retainers<br>Use With # 18145 & 18255<br>Ford # W708035-S300 | <b>25 Pcs.</b> |  |  |
|----------------|--|----------------|--|---|

# Ford







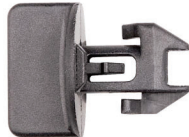



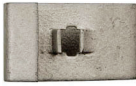

## Grommets

|                |  |                |   |   |
|----------------|--|----------------|---|---|
| <b>18145PK</b> | 3/8" (9.50mm) Hole Size<br>21mm Stem Length<br>Natural Rubber<br>Rear Bumper Cover Grommets<br>Use With # 17832                      | <b>25 Pcs.</b> |  |  |
| <b>18255PK</b> | 3/8" (9.50mm) Hole Size<br>21mm Stem Length<br>Black Rubber<br>Rear Bumper Cover Grommets<br>Use With # 17832<br>Ford # W708045-S300 | <b>25 Pcs.</b> |  |  |

## Retainers Miscellaneous

|                |   |                |   |   |
|----------------|---|----------------|---|---|
| <b>11960PK</b> | 6.50 x 12.00mm Hole Size<br>Black Nylon<br>Instrument Panel Insulation<br>Front Sight Shield<br>Twist Lock Retainers<br>Ford N811772S<br>G.M. # 2553596 | <b>25 Pcs.</b> |  |  |
|----------------|---|----------------|---|---|







## Nuts Miscellaneous Metric

|                |   |                |   |   |
|----------------|---|----------------|---|---|
| <b>12273PK</b> | #6 (3.50mm) Screw Size<br>10mm Width<br>18mm Height<br>Zinc Finish<br>Bumper & Grille Fasteners<br>Chrysler # 4806226-AA, 68004187-AA<br>Ford # W710754-S439<br>G.M. # 11562364 | <b>15 Pcs.</b> |    |    |
| <b>10733PK</b> | #8 (4.20mm) Screw Size<br>.70 - 1.50mm Panel Range<br>8.70mm Hole Size<br>Gray Finish With Sealer<br>Tail Light Quarter<br>Panel Nuts<br>Ford # W714171-S439<br>G.M. # 11569711 | <b>25 Pcs.</b> |   |   |
| <b>11034PK</b> | #8 (4.20mm) Screw Size<br>9.00 x 11.00mm Hole Size<br>Black Finish Dash<br>Panel Nuts<br>Ford # N803685S<br>G.M. # 14083173, 17997722, 17988488                                 | <b>25 Pcs.</b> |  |  |
| <b>11032PK</b> | #8 (4.20mm) Screw Size<br>.70 - 2.30mm Panel Range<br>8.70mm Hole Size<br>Blue Finish Mid<br>Panel Nuts<br>Chrysler # 6509432AA<br>Ford # W716529-S900<br>G.M. # 1570654        | <b>25 Pcs.</b> |  |  |
| <b>9199PK</b>  | #8 (4.20mm) Screw Size<br>Zinc Finish<br>Radiator Grille Nuts<br>Ford # N802865-S100<br>G.M. # 15686142, 11561448   | <b>25 Pcs.</b> |  |  |
| <b>18096PK</b> | #8 (4.20mm) Screw Size<br>11.70mm Width<br>16.50mm Length<br>Gray Finish With Sealer<br>Specialty Nuts<br>Ford # W713617-S439   | <b>15 Pcs.</b> |  |  |





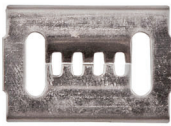

19

# Ford





## Nuts Miscellaneous Metric

|                |  |                |  |   |
|----------------|--|----------------|--|---|
| <b>15983PK</b> | #8 (4.80mm) Screw Size<br>7mm Stem Length<br>14.00 x 23.00mm Head Diameter<br>Zinc Organic<br>Front & Rear Bumper<br>Specialty Nuts With Pasticol Pad<br>Ford # W715197-S439 | <b>10 Pcs.</b> |  |  |
| <b>18802PK</b> | 12mm Width<br>15.30mm Height<br>Silver Finish<br>Bumper Fasteners<br>Ford # W715801-S439   | <b>50 Pcs.</b> |  |  |
| <b>11228PK</b> | 15mm Width<br>17mm Overall Height<br>Black Finish<br>Front Bumper Retainers<br>Ford # W705990-S305   | <b>25 Pcs.</b> |  |  |
| <b>11862PK</b> | 15.50mm Width<br>23.10mm Length<br>Stainless Steel<br>Bumper Cover Retainers<br>Ford # F32Z-17C756-S<br>Mazda # GJ21-50-049  | <b>50 Pcs.</b> |   |  |

## Nutserts Hex Type Automotive





|                |   |                |  |   |
|----------------|---|----------------|--|---|
| <b>12444PK</b> | 6-1.00mm Thread Size<br>8mm Hex Size<br>12mm Flange Diameter<br>.65 - 2.00mm Grip Range<br>Zinc Finish With Sealer<br>Hex Type Steel Nutserts<br>Ford # N803763-S100<br>G.M. # 15685099, 11518684 | <b>15 Pcs.</b> |    |    |
| <b>12443PK</b> | 6-1.00mm Thread Size<br>9.50mm Hex Size<br>13mm Flange Diameter<br>.50 - 4.20mm Grip Range<br>Yellow Zinc With Sealer<br>Hex Type Steel Nutserts<br>Ford # W706172-S309, W708384-S309             | <b>15 Pcs.</b> |  |  |
| <b>11406PK</b> | 8-1.25mm Thread Size<br>12.70mm Hex Size<br>22mm Flange Diameter<br>.70 - 3.80mm Grip Range<br>Zinc Finish<br>Hex Type Steel Nutserts<br>Ford # W708513-S437                                      | <b>15 Pcs.</b> |  |  |

## Nuts Jack











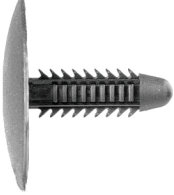

|               |  |                |  |   |
|---------------|--|----------------|--|---|
| <b>1793PK</b> | 6-1.00mm Thread Size<br>Roof Rack Mounting<br>Raintite Sealer Type<br>Steel Jack Nuts<br>G.M. # 14007940   | <b>10 Pcs.</b> |  |  |
| <b>1589PK</b> | 6-1.00 x 26.00mm<br>T30 Torx® Drive<br>16mm Loose Washer Chrome<br>Outside Mirror Mounting Bolts<br>Use With # 1793<br>Ford # N801851-S, N800928-S45,<br>N806345-S47, N806345-S433 | <b>10 Pcs.</b> |  |  |

# Ford

## Rubber Products

|                |  |                |   |   |
|----------------|--|----------------|---|---|
| <b>10047PK</b> | 1/4" (6.35mm) Hole Size<br>7/16" Stem Length<br>1/4 x 3/8" Head Diameter<br>Black Rubber<br>Gas Tank Bumper<br>Ford # 357811       | <b>25 Pcs.</b> |  |  |
| <b>10449PK</b> | 9/32" (7.14mm) Hole Size<br>19/32" Stem Length<br>15/32" Head Diameter<br>Black Rubber<br>General Purpose Bumpers<br>Ford # 16758A | <b>25 Pcs.</b> |  |  |

## Retainers Shield

|                |  |                 |   |   |
|----------------|--|-----------------|---|---|
| <b>8172PK</b>  | 3/16" (4.50mm) Hole Size<br>21/32" Stem Length<br>7/16" Head Diameter<br>.060 - .390" Panel Range<br>Black Nylon<br>Dash Panel Retainers<br>G.M. # 25016383, 20413107<br>Ford # 388246A<br>AMC # 4006516 | <b>50 Pcs.</b>  |    |    |
| <b>9178PK</b>  | 13/64" (5mm) Hole Size<br>1/2" Stem Length<br>7/16" Head Diameter<br>Black Nylon<br>Fascia Shield Retainers<br>Ford # N803170-S<br>G.M. # 16517439   | <b>25 Pcs.</b>  |    |    |
| <b>5614PK</b>  | 7/32" (5.60mm) Hole Size<br>25/32" Stem Length<br>1" Head Diameter<br>.080 - .545" Panel Range<br>Black Nylon<br>Shield Retainers<br>Ford # N808370-S  | <b>50 Pcs.</b>  |    |   |
| <b>11002PK</b> | 15/64" (6mm) Hole Size<br>20mm Stem Length<br>18mm Head Diameter<br>Black Nylon<br>Bumper & Fender Apron Retainers<br>G.M. # 11589181<br>Ford # W711687-S300   | <b>25 Pcs.</b>  |  |  |
| <b>10568PK</b> | 15/64" (6mm) Hole Size<br>33mm Stem Length<br>18mm Head Diameter<br>Black Nylon<br>Wheel Well Shield Retainers<br>G.M. # 11588950<br>Ford # W709002, W709002-SAA   | <b>25 Pcs.</b>  |  |  |
| <b>10400PK</b> | 1/4" (6.30mm) Hole Size<br>8.70mm Stem Length<br>14mm Head Diameter<br>Black Nylon<br>Front End Fascia Retainers<br>Ford # N803857S  | <b>50 Pcs.</b>  |  |  |
| <b>1410PK</b>  | 1/4" (6.30mm) Hole Size<br>1/2" Stem Length<br>3/4" Head Diameter<br>Black Nylon<br>Mud Shield Retainers<br>G.M. # 20032850<br>Ford # 387258-S<br>Chrysler # 3861577                                     | <b>100 Pcs.</b> |  |  |

# Ford















## Retainers Shield

|         |  |          |  |  |
|---------|--|----------|--|--|
| 5429PK  | 1/4" (6.30mm) Hole Size<br>21/32" Stem Length<br>11/16" Head Diameter<br>.115 - .400" Panel Range<br>Black Nylon<br>Bumper & Fender Shield Retainers<br>G.M. # 332364, 14093311, 20732399<br>Ford # 389358-S<br>Chrysler # 6031321, 3691590<br>AMC # 4004569                                   | 100 Pcs. |  |  |
| 5625PK  | 1/4" (6.30mm) Hole Size<br>13/16" Stem Length<br>23/32" Head Diameter<br>.095 - .540" Panel Range<br>Black Nylon<br>Fender & Bumper Shield Retainers<br>G.M. # 1605396, 11569768, 15958694<br>Ford # 388577S, 389358S, W705589-S300<br>Chrysler # 6036007AA, 6502078, 6030441<br>AMC # 4004919 | 100 Pcs. |  |  |
| 9446PK  | 1/4" (6.30mm) Hole Size<br>15/16" Stem Length<br>1/2" Head Diameter<br>Black Nylon<br>Engine Mount Heat Retainers<br>Ford # N804448  | 25 Pcs.  |  |  |
| 9130PK  | 1/4" (6.30mm) Hole Size<br>1 1/16" Stem Length<br>23/32" Head Diameter<br>.095 - .805" Panel Range<br>Black Nylon<br>Engine Splash Shield Retainers<br>Chrysler # 6033082, 6033840<br>Ford # W709346-S300, 39001S<br>G.M. # 10121502, 10077401   | 50 Pcs.  |  |  |
| 5627PK  | 1/4" (6.30mm) Hole Size<br>1 3/32" Stem Length<br>1" Head Diameter<br>.100 - .685" Panel Range<br>Black Nylon<br>Trim Panel Retainers<br>Ford # 388930-S, 391039-S   | 50 Pcs.  |  |  |
| 11250PK | 1/4" (6.30mm) Hole Size<br>28mm Stem Length<br>26mm Head Diameter<br>Black Nylon<br>Fender Liner Retainers<br>Ford # W706635-SSW   | 50 Pcs.  |  |  |
| 9510PK  | 1/4" (6.30mm) Hole Size<br>1 1/8" Stem Length<br>1" Head Diameter<br>Black Nylon Cowl Side Trim<br>Shield Retainers<br>Ford # E9SB-6302354-ACW   | 25 Pcs.  |  |  |

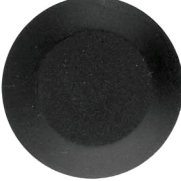
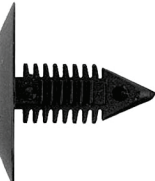
19

# Ford

## Retainers Shield

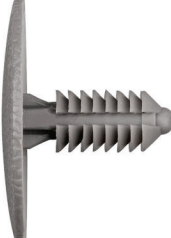
|                |   |                |  |   |
|----------------|---|----------------|--|---|
| <b>10434PK</b> | 1/4" (6.30mm) Hole Size<br>35mm Stem Length<br>18mm Head Diameter<br>10.50mm - 26.60mm Panel Range<br>Charcoal Gray Nylon<br>Wheel Opening Moulding Retainers<br>Ford # W705955-S300<br>G.M. # 10146315 | <b>50 Pcs.</b> |   |    |
| <b>10975PK</b> | 1/4" (6.30mm) Hole Size<br>35mm Stem Length<br>22mm Head Diameter<br>Black Nylon<br>Fender Liner & Mud Flap Retainers<br>Ford # W701855-S300  | <b>25 Pcs.</b> |    |    |
| <b>10064PK</b> | 1/4" (6.30mm) Hole Size<br>45mm Stem Length<br>18mm Head Diameter<br>3.20 - 40.00mm Panel Range<br>Black Nylon<br>Mud Flap Retainers<br>Ford # W707889-S300   | <b>25 Pcs.</b> |   |    |
| <b>1408PK</b>  | 9/32" (7mm) Hole Size<br>9/16" Stem Length<br>13/32 x 1" Head Diameter<br>Black Nylon<br>Cowl Insulation Retainers<br>Ford # 384051-S<br>G.M. # 480534  | <b>25 Pcs.</b> |   |    |
| <b>9485PK</b>  | 9/32" (7mm) Hole Size<br>3/4" Stem Length<br>15/16" Head Diameter<br>Black Nylon<br>Door Trim Panel Retainers<br>Chrysler # 6032363<br>Ford # 385661-S<br>V.W. # N989022                                | <b>25 Pcs.</b> |  |  |
| <b>5635PK</b>  | 9/32" (7mm) Hole Size<br>20mm Stem Length<br>25mm Head Diameter<br>2.56 - 12.96mm Panel Range<br>Black Nylon<br>Interior Trim Retainers<br>Chrysler # 6506788<br>Ford # N802734S<br>G.M. # 22718305     | <b>50 Pcs.</b> |  |  |
| <b>12127PK</b> | 9/32" (7mm) Hole Size<br>20mm Stem Length<br>25mm Head Diameter<br>2.56 - 12.96mm Panel Range<br>Gray Nylon<br>Interior Trim Retainers<br>Ford # N802734-S  | <b>50 Pcs.</b> |  |  |
| <b>9529PK</b>  | 9/32" (7mm) Hole Size<br>20mm Stem Length<br>32mm Head Diameter<br>Gray Nylon<br>Headliner Retainers<br>Ford # N805315  | <b>10 Pcs.</b> |  |  |

# Ford

## Retainers Shield

|                 |   |                |  |  |
|-----------------|---|----------------|--|--|
| <b>1149PK</b>   | 9/32" (7mm) Hole Size<br>20.50mm Stem Length<br>25mm Head Diameter<br>2.50 - 13.50mm Panel Range<br>Black Nylon<br>Door Frame Spacer Retainers<br>Chrysler # 4381395, 6501086<br>Ford # 388904-S, N802224-S | <b>25 Pcs.</b> |  |  |
| <b>9849PK</b>   | 9/32" (7mm) Hole Size<br>27/32" Stem Length<br>1" Head Diameter<br>.106 - .540" Panel Range<br>Black Nylon<br>Fascia Panel Retainers<br>Ford # 389443-S   | <b>25 Pcs.</b> |  |  |
| <b>18826PK</b>  | 17/64" (7mm) Hole Size<br>22mm Stem length<br>19mm Head Diameter<br>Black Nylon<br>Headlight & Instrument Panel Retainers<br>Ford # W717082-S300, W710825-S300  | <b>50 Pcs.</b> |  |  |
| <b>9523PK</b>   | 9/32" (7mm) Hole Size<br>1 3/32" Stem Length<br>1 1/32" Head Diameter<br>Black Nylon<br>Headliner Retainers<br>Ford # W710923-S300<br>G.M. # 10229437, 10242316   | <b>25 Pcs.</b> |  |  |
| <b>13093PK</b>  | 9/32" (7mm) Hole Size<br>30mm Stem Length<br>23mm Head Diameter<br>Black Nylon Cowl, Interior Trim &<br>Splash Shield Retainers<br>Ford # W714076-SS3JA   | <b>25 Pcs.</b> |  |  |
| <b>2048PK</b>   | 9/32" (7mm) Hole Size<br>38.50mm Stem Length<br>26mm Head Diameter<br>.075 - 1.25" Panel Range<br>Black Nylon<br>Interior Trim Retainers<br>Ford # N804349S   | <b>25 Pcs.</b> |  |  |
| <b>JL-120PK</b> | 9/32" (7mm) Hole Size<br>1 3/4" Stem Length<br>3/4" Head Diameter<br>.075 - 1.510" Panel Range<br>Black Nylon<br>Trim Panel Retainers<br>Ford # E7EB5802354AAJABH   | <b>25 Pcs.</b> |  |  |
| <b>10517PK</b>  | 19/64" (7.50mm) Hole Size<br>32mm Stem Length<br>18mm Head Diameter<br>Black Nylon<br>Cowl Vent Retainers<br>Ford # W710312-S300  | <b>25 Pcs.</b> |  |  |

19

# Ford

## Retainers Shield

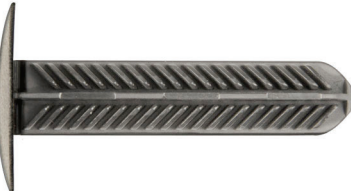

|                 |  |                |  |   |
|-----------------|--|----------------|--|---|
| <b>10675PK</b>  | 19/64" (7.60mm) Hole Size<br>22mm Stem Length<br>18mm Head Diameter<br>Black Nylon<br>Radiator Side Shield Retainers<br>Ford # W7015380-SSW  | <b>25 Pcs.</b> |   |    |
| <b>10448PK</b>  | 5/16" (7.90mm) Hole Size<br>1 1/2" Stem Length<br>1" Head Diameter<br>Gray Nylon<br>Trim Panel Retainers<br>Ford # N806344-S   | <b>25 Pcs.</b> |    |    |
| <b>16312PK</b>  | 21/64" (8.50mm) Hole Size<br>63.50mm Stem Length<br>30mm Head Diameter<br>Gray Nylon<br>Headliner Retainers<br>Ford # W717918-SS34X  | <b>15 Pcs.</b> |    |    |
| Not Actual Size |  |                |  |   |
| <b>5643PK</b>   | 23/64" (9mm) Hole Size<br>19.50mm Stem Length<br>16mm Head Diameter<br>.060 - .510" Panel Range<br>Black Nylon<br>Trim Panel Retainers<br>Chrysler # 6504043, 650403<br>Ford # N807721-S                           | <b>50 Pcs.</b> |   |    |
| <b>10469PK</b>  | 23/64" (9mm) Hole Size<br>20mm Stem Length<br>24mm Head Diameter<br>1.60 - 10.00mm Panel Range<br>Black Nylon<br>Front End Retainers<br>Chrysler # 6505667-AA<br>Ford # N811540-S, W705681-S300<br>G.M. # 22189414 | <b>25 Pcs.</b> |  |  |
| <b>5648PK</b>   | 25/64" (10mm) Hole Size<br>30mm Stem Length<br>22mm Head Diameter<br>.040 - .790" Panel Range<br>Black Nylon<br>Fascia Bumper Retainers<br>Chrysler # 34202787<br>Ford # N804379-S<br>G.M. # 1631564               | <b>50 Pcs.</b> |  |  |

## Retainers Door Trim Panel

|                |  |                |  |   |
|----------------|--|----------------|--|---|
| <b>18166PK</b> | 13/32" (10.50mm) Hole Size<br>45mm Stem Length<br>25mm Head Diameter<br>Black Nylon<br>Rear Body & Trim Retainers<br>Ford # W715951-S300 | <b>15 Pcs.</b> |  |  |
|----------------|--|----------------|--|---|



# Ford

## Retainers Hood Seal



|               |  |                |  |   |
|---------------|--|----------------|--|---|
| <b>9522PK</b> | 15/64" (6mm) Hole Size<br>10mm Stem Length<br>14mm Head Diameter<br>Black Nylon<br>Hood Insulation Retainers<br>Mazda # B455-56-741<br>Ford # F1CZ-16774-A | <b>25 Pcs.</b> |  |  |
|---------------|--|----------------|--|---|



## Clips Hood Prop Rod

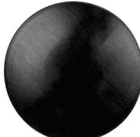

|                |   |                |  |   |
|----------------|---|----------------|--|---|
| <b>10076PK</b> | 5/16" Rod Size<br>Natural Nylon<br>Hood Prop Rod Clips<br>Ford # 386299-S | <b>25 Pcs.</b> |  |  |
|----------------|---|----------------|--|---|



|                |  |                |  |   |
|----------------|--|----------------|--|---|
| <b>10081PK</b> | 5/16" Rod Size<br>Natural Nylon<br>Hood Prop Rod Clips<br>Ford # E83Z-16828A | <b>10 Pcs.</b> |  |  |
|----------------|--|----------------|--|---|



## Retainers Hood Insulation

|                |  |                |  |   |
|----------------|--|----------------|--|---|
| <b>10613PK</b> | 3/16" (4.80mm) Hole Size<br>12mm Stem Length<br>19mm Head Diameter<br>Black Nylon<br>Hood Insulation Retainers<br>Ford # W701374-S, W701374-S300 | <b>25 Pcs.</b> |  |  |
|----------------|--|----------------|--|---|

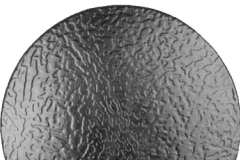
|                |   |                |   |  |
|----------------|---|----------------|---|--|
| <b>13315PK</b> | 15/64 (6mm) Hole Size<br>9mm Stem Length<br>20mm Head Diameter<br>Black Nylon<br>Hood Insulation Retainers<br>Ford # F22Z-16774-A, GA2A-56694<br>Mazda # G030-68-885-B-38 | <b>25 Pcs.</b> |  |  |
|----------------|---|----------------|---|--|

|              |  |                |  |   |
|--------------|--|----------------|--|---|
| <b>969PK</b> | 1/4" (6.30mm) Hole Size<br>5/8" Stem Length<br>1/2 x 1 1/2" Head Diameter<br>Black Nylon<br>Hood Insulation Retainers<br>Chrysler # 6003351<br>Ford # 385330-S, D30Z-16776-A | <b>25 Pcs.</b> |  |  |
|--------------|--|----------------|--|---|

|               |   |                |  |   |
|---------------|---|----------------|--|---|
| <b>2111PK</b> | 1/4" (6.30mm) Hole Size<br>18mm Stem Length<br>32mm Head Diameter<br>Black Nylon<br>Hood Insulation Retainers<br>Chrysler # 6504098<br>Ford # N808842-S, W705002-S300 | <b>50 Pcs.</b> |  |  |
|---------------|---|----------------|--|---|

|               |   |                |  |   |
|---------------|---|----------------|--|---|
| <b>9588PK</b> | 1/4" (6.30mm) Hole Size<br>3/4" Stem Length<br>1 3/16" Head Diameter<br>Black Nylon<br>Hood Insulation Retainers<br>Ford # 386553-S, 385595-S | <b>50 Pcs.</b> |  |  |
|---------------|---|----------------|--|---|



# Ford

## Retainers Hood Insulation



|                |  |                |  |   |
|----------------|--|----------------|--|---|
| <b>1573PK</b>  | 1/4" (6.30mm) Hole Size<br>3/4" Stem Length<br>1 3/4" Head Diameter<br>Black Nylon<br>Hood Insulation Retainers<br>Ford # 388908-S                               | <b>50 Pcs.</b> |    |    |
| <b>9513PK</b>  | 1/4" (6.30mm) Hole Size<br>7/8" Stem Length<br>1 3/4" Head Diameter<br>Black Nylon<br>Hood Insulation Retainers<br>Ford # N803613-S                              | <b>25 Pcs.</b> |    |    |
| <b>10670PK</b> | 1/4" (6.30mm) Hole Size<br>1" Stem Length<br>1 3/4" Head Diameter<br>Black Nylon<br>Trim Panel Retainers<br>Chrysler # 6505302AA<br>Ford # N803387, N803387-S300 | <b>25 Pcs.</b> |   |   |
| <b>16082PK</b> | 17mm Overall Height<br>15mm Stem Length<br>25.00 x 30.00mm Head Size<br>Black Nylon<br>Hood Insulation Retainers<br>Ford # W716783-S300                          | <b>25 Pcs.</b> |  |  |
| <b>11852PK</b> | 19/64" (7.60mm) Hole Size<br>13mm Stem Length<br>31mm Head Diameter<br>Black Nylon<br>Hood Insulation Retainers<br>Ford # W708633-S300                           | <b>25 Pcs.</b> |  |  |

# Ford

## Retainers Hood Insulation



|                |   |                |  |   |
|----------------|---|----------------|--|---|
| <b>10677PK</b> | 21/64" (8.50mm) Hole Size<br>12.50mm Stem Length<br>25mm Head Diameter<br>Black Nylon<br>Hood Insulation Retainers<br>Ford # W700671-S300 | <b>25 Pcs.</b> |  |  |
|----------------|---|----------------|--|---|



## Retainers Hood Adjustment



|                |  |                |  |   |
|----------------|--|----------------|--|---|
| <b>12849PK</b> | 6-1.00mm Thread Size<br>Black Nylon<br>Metal Insert Threaded<br>Hood Adjustment Nuts<br>Ford 1989-On | <b>10 Pcs.</b> |  |  |
|----------------|--|----------------|--|---|



## Retainers Weatherstrip



|               |  |                |  |   |
|---------------|--|----------------|--|---|
| <b>9875PK</b> | 11/64" (4.50mm) Hole Size<br>16mm Stem Length<br>5.00 x 13.00mm Head Size<br>Natural Nylon<br>Weatherstrip Retainers<br>Ford # C5AB-6220586A | <b>50 Pcs.</b> |  |  |
|---------------|--|----------------|--|---|



|                |  |                 |   |  |
|----------------|--|-----------------|---|--|
| <b>10663PK</b> | 13/64" (5mm) Hole Size<br>7.80mm Stem Length<br>5.00 x 15.00mm Head Size<br>Yellow Nylon<br>Weatherstrip Retainers<br>Honda # 90651-TP8-003, 91568-TR0-003 | <b>100 Pcs.</b> |  |  |
|----------------|--|-----------------|---|--|

|                |   |                 |  |   |
|----------------|---|-----------------|--|---|
| <b>15171PK</b> | 13/64" (5mm) Hole Size<br>8mm Stem Length<br>5.00 x 15.00mm Head Diameter<br>White Nylon<br>Weatherstrip Retainers<br>Ford # W711858-S300 | <b>100 Pcs.</b> |  |  |
|----------------|---|-----------------|--|---|

|                |  |                 |  |   |
|----------------|--|-----------------|--|---|
| <b>10521PK</b> | 13/64" (5mm) Hole Size<br>10mm Stem Length<br>5.00 x 14.00mm Head Diameter<br>Blue Nylon<br>Weatherstrip Retainers<br>Ford | <b>100 Pcs.</b> |  |  |
|----------------|--|-----------------|--|---|

|                |   |                 |  |   |
|----------------|---|-----------------|--|---|
| <b>18793PK</b> | 13/64" (5mm) Hole Size<br>10mm Stem Length<br>12mm Head Diameter<br>Black Nylon<br>Weatherstrip Retainers<br>Ford # W712792-S300<br>Honda # 91563-TG7-A00 | <b>100 Pcs.</b> |  |  |
|----------------|---|-----------------|--|---|











|                |   |                |  |   |
|----------------|---|----------------|--|---|
| <b>12069PK</b> | 13/64" (5mm) Hole Size<br>10mm Stem Length<br>5.00 x 15.00mm Head Diameter<br>Natural Nylon<br>Weatherstrip Retainers<br>Ford # E7GZ-6120586-B<br>Hyundai # 86438-2B000<br>Mazda # G031-58-762<br>Toyota # 67867-89103, 97868-89101,<br>67867-28030 | <b>50 Pcs.</b> |  |  |
|----------------|---|----------------|--|---|

|                |  |                 |  |   |
|----------------|--|-----------------|--|---|
| <b>12067PK</b> | 13/64" (5mm) Hole Size<br>8mm Stem Length<br>5.00 x 15.00mm Head Diameter<br>Natural Nylon<br>Weatherstrip Retainers<br>Ford # N806340-S | <b>100 Pcs.</b> |  |  |
|----------------|--|-----------------|--|---|





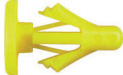

19

# Ford

## Retainers Weatherstrip

|                |   |                 |   |   |
|----------------|---|-----------------|---|---|
| <b>10661PK</b> | 13/64" (5.30mm) Hole Size<br>8.60mm Stem Length<br>5.00 x 15.00mm Head Size<br>Yellow Nylon<br>Door & Hood Seal<br>Weatherstrip Retainers<br>Ford                                       | <b>100 Pcs.</b> |    |    |
| <b>18791PK</b> | 15/64" (5.80mm) Hole Size<br>9.50mm Stem Length<br>5.00 x 15.00mm Head Diameter<br>Green Nylon<br>Fender Seal & Weatherstrip Retainers<br>Ford N/A                                      | <b>50 Pcs.</b>  |    |    |
| <b>9208PK</b>  | 15/64" (6mm) Hole Size<br>10mm Stem Length<br>5.00 x 15.00mm Head Size<br>Orange Nylon<br>Weatherstrip Retainers<br>Ford # N807438S<br>Honda # 91530-SP1-003, 91530-SPL-003,<br>W704643 | <b>25 Pcs.</b>  |    |    |
| <b>9264PK</b>  | 15/64" (6mm) Hole Size<br>12.30mm Stem Length<br>5.25 x 14.20mm Head Diameter<br>Black Nylon<br>Weatherstrip Retainers<br>Ford # N806289-S  | <b>50 Pcs.</b>  |    |    |
| <b>10462PK</b> | 15/64" (6mm) Hole Size<br>15.50mm Stem Length<br>12.60mm Head Diameter<br>.80 - 8.00mm Panel Range<br>Black Nylon<br>Weatherstrip Retainers<br>Ford # N811040-S<br>G.M. # 10293193      | <b>50 Pcs.</b>  |    |    |
| <b>10567PK</b> | 17/64" (6.80mm) Hole Size<br>14.50mm Stem Length<br>9mm Head Diameter<br>Yellow Nylon<br>Weatherstrip Retainers<br>Ford   | <b>100 Pcs.</b> |  |  |

## Retainers Push Type

|                |  |                |   |   |
|----------------|--|----------------|---|---|
| <b>9617PK</b>  | 15/64" (6mm) Hole Size<br>16mm Stem Length<br>17mm Flange Diameter<br>Black Nylon<br>Radiator & Fender<br>Push Type Retainers<br>Chrysler # 6506008-AA<br>Ford # W709176-S300<br>G.M. # 15149708 | <b>25 Pcs.</b> |  |  |
| <b>9320PK</b>  | 15/64" (6mm) Hole Size<br>23mm Stem Length<br>15mm Flange Diameter<br>Black Nylon<br>Push Type Fascia Retainers<br>Chrysler # 4857108<br>Ford # N803709S<br>G.M. # 15681408, 25642453            | <b>50 Pcs.</b> |  |  |
| <b>10424PK</b> | 1/4" (6.30mm) Hole Size<br>7/16" Stem Length<br>5/8" Flange Diameter<br>Black Nylon<br>Headlight Bracket<br>Push Type Retainers<br>Ford # 383142-S   | <b>50 Pcs.</b> |  |  |

# Ford

















## Retainers Push Type

|                |   |                |  |  |
|----------------|---|----------------|--|--|
| <b>5675PK</b>  | 1/4" (6.30mm) Hole Size<br>9/16" Stem Length<br>11/16" Flange Diameter<br>Black Nylon<br>Fender & Mud Skirt<br>Push Type Retainers<br>AMC # 8934-201-621<br>AMC/Jeep # 6503454<br>Chrysler # 34201621, 06504090<br>Ford # E308-4A163CA<br>G.M. # 14019205, 14019206 | <b>50 Pcs.</b> |  |  |
| <b>10419PK</b> | 1/4" (6.30mm) Hole Size<br>5/8" Stem Length<br>19/32" Flange Diameter<br>Black Nylon<br>Fender Shield<br>Push Type Retainers<br>Ford # 387843-S   | <b>50 Pcs.</b> |  |  |
| <b>9858PK</b>  | 1/4" (6.30mm) Wide Slot<br>11/16" Stem Length<br>3/4" Flange Diameter<br>Black Nylon<br>Grille Retainers<br>Ford # 387944-S   | <b>50 Pcs.</b> |  |  |
| <b>12015PK</b> | 1/4" (6.30mm) Hole Size<br>18mm Stem Length<br>18mm Flange Diameter<br>Black Nylon Stone Deflector<br>Push Type Retainers<br>Ford # N808048-S, W705532-S300   | <b>25 Pcs.</b> |  |  |
| <b>9559PK</b>  | 1/4" (6.30mm) Hole Size<br>3/4" Stem Length<br>19/32" Flange Diameter<br>Black Nylon<br>Wheel Moulding<br>Push Type Retainers<br>Chrysler # 6509103AA, 6509103-AA<br>Ford # W705436-S300<br>G.M. # 21077123, 20730531   | <b>25 Pcs.</b> |  |  |
| <b>2045PK</b>  | 1/4" (6.30mm) Hole Size<br>13/16" Stem Length<br>11/16" Flange Diameter<br>Black Nylon<br>Push Type Retainers<br>Chrysler # 6501925<br>Ford # F50C-9E728-AA<br>G.M. # 10134407, 15990756  | <b>25 Pcs.</b> |  |  |
| <b>18221PK</b> | 1/4" (6.30mm) Hole Size<br>7/8" Stem Length<br>11/16" Flange Diameter<br>Black Nylon Body<br>Push Type Retainers<br>Chrysler # 34202672<br>Ford # N803362-S<br>G.M. # 20510029  | <b>25 Pcs.</b> |  |  |
| <b>5935PK</b>  | 1/4" (6.30mm) Hole Size<br>7/8" Stem Length<br>1" Flange Diameter<br>Black Nylon Splash Shield<br>Push Type Retainers<br>Chrysler # 55176248<br>Ford # 802781-S, W704340-S300,<br>N802781-S<br>G.M. # 14093088  | <b>25 Pcs.</b> |  |  |

19

# Ford

## Retainers Push Type

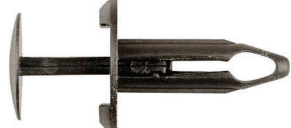
|                |   |                |   |   |
|----------------|---|----------------|---|---|
| <b>15852PK</b> | 1/4" (6.40mm) Hole Size<br>17/32" Stem Length<br>5/8" Head Diameter<br>Black Nylon<br>Push Type Retainers<br>Ford # N805231S  | <b>50 Pcs.</b> |    |    |
| <b>17922PK</b> | 1/4" (6.50mm) Hole Size<br>11mm Stem Length<br>25mm Flange Diameter<br>Black Nylon<br>Splash & Heat Shield<br>Push Type Retainers<br>Ford # W717823-S300  | <b>15 Pcs.</b> |     |    |
| <b>10368PK</b> | 1/4" (6.50mm) Hole Size<br>17.50mm Stem Length<br>18mm Flange Diameter<br>2.00 - 4.50mm Panel Range<br>Black Nylon<br>Push Type Retainers<br>Chrysler # 6508863AA<br>Ford # W713610-S300<br>G.M. # 11589289 | <b>25 Pcs.</b> |    |    |
| <b>10369PK</b> | 1/4" (6.50mm) Hole Size<br>20mm Stem Length<br>18mm Flange Diameter<br>4.50 - 7.00mm Panel Range<br>Black Nylon<br>Push Type Retainers<br>Chrysler # 6509049-AA<br>Ford # W714040-S300<br>G.M. # 11589290   | <b>50 Pcs.</b> |    |    |
| <b>10367PK</b> | 1/4" (6.50mm) Hole Size<br>22mm Stem Length<br>18mm Flange Diameter<br>7.00 - 9.50mm Panel Range<br>Black Nylon<br>Push Type Retainers<br>Ford # W713331-S300<br>G.M. # 11589291                            | <b>25 Pcs.</b> |  |  |
| <b>18789PK</b> | 9/32" (7mm) Hole Size<br>9mm Stem Length<br>14mm Head Diameter<br>Black Nylon<br>Push Type Retainers<br>Ford # N807673-S<br>G.M. # 25612368   | <b>10 Pcs.</b> |  |  |
| <b>15027PK</b> | 9/32" (7mm) Hole Size<br>12mm Stem Length<br>18mm Head Diameter<br>Black Nylon<br>Lower Radiator Shield<br>Push Type Retainers<br>Ford # W716510-S300   | <b>10 Pcs.</b> |  |  |
| <b>9138PK</b>  | 9/32" (7mm) Hole Size<br>20mm Stem Length<br>18mm Head Diameter<br>Black Nylon Fender Apron<br>Push Type Retainers<br>Ford # W718088-S300   | <b>25 Pcs.</b> |  |  |
| <b>12016PK</b> | 9/32" (7mm) Hole Size<br>23mm Stem Length<br>18mm Head Diameter<br>Black Nylon Fascia Retainers<br>Ford # N803716-S, 803716-S   | <b>25 Pcs.</b> |  |  |











# Ford

## Retainers Push Type

|         |   |         |  |  |
|---------|---|---------|--|--|
| 5676PK  | 5/16" (8mm) Hole Size<br>13.50mm Stem Length<br>17mm Flange Diameter<br>Black Nylon Radiator<br>Push Type Retainers<br>Chrysler # 175720B010<br>Ford # 04388293<br>G.M. # 14071289, 14019226        | 25 Pcs. |  |  |
| 9292PK  | 5/16" (8mm) Hole Size<br>10mm Stem Length<br>20mm Flange Diameter<br>Black Nylon Front Fender<br>Push Type Retainers<br>Ford # W711712-S300<br>Honda # 91501-S04-003                                | 15 Pcs. |  |  |
| 1861PK  | 5/16" (8mm) Hole Size<br>20mm Stem Length<br>15mm Flange Diameter<br>Black Nylon<br>Rocker Panel Retainers<br>Chrysler # 6504555<br>Ford # F3LB-14K056-AA<br>G.M. # 21075686                        | 25 Pcs. |  |  |
| 1860PK  | 5/16" (8mm) Hole Size<br>20mm Stem Length<br>20mm Flange Diameter<br>Black Nylon Air Baffle<br>Push Type Retainers<br>Chrysler # 6503598<br>Ford # N807389S, 807389S<br>G.M. # 21030249, 15969147   | 25 Pcs. |  |  |
| 10460PK | 5/16" (8mm) Hole Size<br>20.50mm Stem Length<br>34mm Flange Diameter<br>3.50mm Shoulder<br>Black & Natural Nylon With Sealer<br>Fascia Retainers<br>Chrysler# 4805405AA<br>Ford # 1L5Z-17K826AA     | 15 Pcs. |  |  |
| 5940PK  | 5/16" (8mm) Hole Size<br>7/8" Stem Length<br>1" Flange Diameter<br>Black Nylon<br>Splash Shield<br>Push Type Retainers<br>Ford # N804614S, N803934-S<br>G.M. # 20570245, 20635065                   | 25 Pcs. |  |  |
| 1263PK  | 5/16" (8mm) Hole Size<br>29/32" Stem Length<br>1" Flange Diameter<br>7/64" Shoulder<br>Black Nylon Splash Shield & Fascia<br>Push Type Retainers<br>Chrysler # 6500725, 6501590<br>Ford # N803421-S | 25 Pcs. |  |  |
| 10504PK | 5/16" (8mm) Hole Size<br>26mm Stem Length<br>20mm Flange Diameter<br>Black Nylon<br>Fender Shield<br>Push Type Retainers<br>Ford # W708530-S300<br>G.M. # 11518017                                  | 15 Pcs. |  |  |

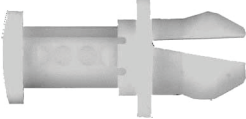
# Ford

## Retainers Push Type



|                |  |                |   |   |
|----------------|--|----------------|---|---|
| <b>10239PK</b> | 21/64" (8.30mm) Hole Size<br>14mm Stem Length<br>19mm Flange Diameter<br>2.70 - 5.30mm Panel Range<br>Black Nylon<br>Push Type Retainers<br>Ford # W715537-S300<br>G.M. # 11609417                           | <b>50 Pcs.</b> |    |    |
| <b>10374PK</b> | 21/64" (8.50mm) Hole Size<br>22mm Stem Length<br>20mm Flange Diameter<br>4.50 - 7.00mm Panel Range<br>Black Nylon<br>Push Type Retainers<br>Ford # W712196-S300<br>G.M. # 11589293                           | <b>25 Pcs.</b> |    |    |
| <b>12077PK</b> | 21/64" (8.50mm) Hole Size<br>24mm Stem Length<br>25mm Flange Diameter<br>Black Nylon Front Fender<br>Push Type Retainers<br>Ford # W718365-S300  | <b>10 Pcs.</b> |     |    |
| <b>17082PK</b> | 23/64" (9mm) Hole Size<br>12mm Stem Length<br>25mm Flange Diameter<br>Black Nylon<br>Cowl Push Type Retainers<br>Ford # W705956-S300   | <b>15 Pcs.</b> |    |   |
| <b>15517PK</b> | 23/64" (9mm) Hole Size<br>22mm Stem Length<br>19mm Flange Diameter<br>Gray Nylon Trim, Dash &<br>Console Push Type Retainers<br>Chrysler # 5GC71RC3AA, 5GF92RC3AA<br>Ford # N808791                          | <b>25 Pcs.</b> |  |  |
| <b>5678PK</b>  | 25/64" (10mm) Hole Size<br>12.50mm Stem Length<br>16mm Flange Diameter<br>Natural Nylon<br>Push Type Retainers<br>Ford # XL3Z-17E971-AA, XL34-17E971-AA  | <b>25 Pcs.</b> |  |  |
| <b>10518PK</b> | 25/64" (10mm) Hole Size<br>16mm Stem Length<br>20mm Flange Diameter<br>Black Nylon<br>Radiator Grille<br>Push Type Retainers<br>Ford # W714584-S300<br>Chrysler # 6507669-AA                                 | <b>25 Pcs.</b> |  |  |
| <b>10377PK</b> | 13/32" (10.50mm) Hole Size<br>20mm Stem Length<br>25mm Flange Diameter<br>3.00 - 6.00mm Panel Range<br>Black Nylon<br>Push Type Retainers<br>Chrysler # 5GUU9K11BA<br>Ford # W712665-S300<br>G.M. # 11589295 | <b>15 Pcs.</b> |   |  |

19

# Ford

## Retainers Push Type

|                |   |               |  |   |
|----------------|---|---------------|--|---|
| <b>10734PK</b> | 5/8" (16mm) Slotted Hole<br>25mm Stem Length<br>19.80 x 36.00mm Head Diameter<br>Black Nylon<br>Bumper Retainers<br>Ford # N.A. | <b>5 Pcs.</b> |  |  |
|----------------|---|---------------|--|---|



|                |   |                |  |   |
|----------------|---|----------------|--|---|
| <b>17926PK</b> | 8 x 11mm Hole Size<br>18mm Stem Length<br>14mm Head Diameter<br>Black Nylon<br>Push Type Retainers<br>Ford # W719367-S300 | <b>15 Pcs.</b> |  |  |
|----------------|---|----------------|--|---|



## Retainers Phillips Screw

|                |   |                |  |   |
|----------------|---|----------------|--|---|
| <b>13396PK</b> | 13/64" (5mm) Hole Size<br>9mm Stem Length<br>8.50 x 12.00mm Head Diameter<br>Black Nylon Cowl Vent<br>Screw Type Retainers<br>Ford # 3M8Z-1502316-A<br>Mazda # GJ6W-50-715A | <b>15 Pcs.</b> |  |  |
|----------------|---|----------------|--|---|



|               |   |                |   |  |
|---------------|---|----------------|---|--|
| <b>9684PK</b> | 1/4" (6.30mm) Hole Size<br>1/2" Stem Length<br>11/16" Head Diameter<br>Black Nylon Trim Panel<br>Screw Type Retainers<br>Ford # N806322-S | <b>15 Pcs.</b> |  |  |
|---------------|---|----------------|---|--|

|                |   |                |  |   |
|----------------|---|----------------|--|---|
| <b>12472PK</b> | 1/4" (6.30mm) Hole Size<br>14mm Stem Length<br>15mm Flange Diameter<br>Black Nylon Fender Liner<br>Phillips Screw Retainers<br>G.M. # 94530438<br>Ford # B04068865A96 | <b>25 Pcs.</b> |  |  |
|----------------|---|----------------|--|---|

|               |  |                |  |   |
|---------------|--|----------------|--|---|
| <b>1399PK</b> | 1/4" (6.30mm) Square Hole<br>21/32" Stem Length<br>15/32 x 15/32" Flange Size<br>Black Nylon Trim & Grille Fascia<br>Phillips Screw Retainers<br>Ford # N803494S | <b>25 Pcs.</b> |  |  |
|---------------|--|----------------|--|---|

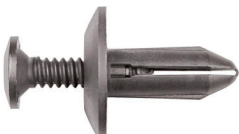
|               |   |                |  |   |
|---------------|---|----------------|--|---|
| <b>9508PK</b> | 1/4" (6.30mm) Hole Size<br>11/16" Stem Length<br>11/16" Flange Size<br>Black Nylon Phillips Screw Retainers<br>Ford # N808147S<br>G.M. # 10139822, 25680782 | <b>25 Pcs.</b> |  |  |
|---------------|---|----------------|--|---|

















|                |   |                |  |   |
|----------------|---|----------------|--|---|
| <b>11262PK</b> | 1/4" (6.30mm) Hole Size<br>18mm Stem Length<br>18mm Flange Diameter<br>Black Nylon Phillips Screw Retainers<br>Chrysler # 6508197-AA<br>Ford # W706092-S300 | <b>25 Pcs.</b> |  |  |
|----------------|---|----------------|--|---|

|                |   |                |  |   |
|----------------|---|----------------|--|---|
| <b>16313PK</b> | 1/4" (6.30mm) Hole Size<br>18mm Stem Length<br>14mm Head Diameter<br>Black Nylon Cowl Vent<br>Phillips Screw Retainers<br>Ford # W703243-S300 | <b>10 Pcs.</b> |  |  |
|----------------|---|----------------|--|---|

19











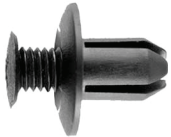

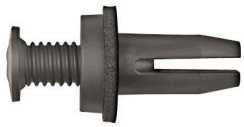

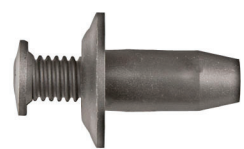
# Ford

## Retainers Phillips Screw

|                |  |                |   |   |
|----------------|--|----------------|---|---|
| <b>9240PK</b>  | 1/4" (6.30mm) Hole Size<br>3/4" Stem Length<br>11/16" Flange Diameter<br>Black Nylon Wheelhouse<br>Phillips Screw Retainers<br>Ford # YS4Z-16K262-AA, 96FG16K262AA   | <b>25 Pcs.</b> |    |    |
| <b>10468PK</b> | 1/4" (6.30mm) Hole Size<br>3/4" Stem Length<br>11/16" Flange Diameter<br>Black Nylon<br>Trim Panel<br>Phillips Screw Retainers<br>Ford # N807578-S, N808332-S  | <b>15 Pcs.</b> |    |    |
| <b>9509PK</b>  | 1/4" (6.30mm) Hole Size<br>7/8" Stem Length<br>1" Flange Diameter<br>Black Nylon Interior Trim<br>Phillips Screw Retainers<br>Ford # N-804837-S  | <b>50 Pcs.</b> |     |    |
| <b>9968PK</b>  | 1/4" (6.30mm) Hole Size<br>29/32" Stem Length<br>5/8" Flange Diameter<br>Black Nylon<br>Phillips Screw Retainers<br>G.M. # 20664091<br>Ford # N803946S N803946-S,<br>W706350-S300, W706350-S3000,<br>W710752-SSC<br>Chrysler # 6502871<br>Mercedes # 000-991-52-40 | <b>50 Pcs.</b> |    |    |
| <b>9067PK</b>  | 1/4" (6.30mm) Hole Size<br>29/32" Stem Length<br>11/16" Flange Diameter<br>Black Nylon Radiator Shroud<br>Phillips Screw Retainers<br>G.M. # 15773445, 20452072, 22538004,<br>20664092<br>Ford # N804570-S<br>Chrysler # 6502790, 4638136                          | <b>25 Pcs.</b> |  |  |
| <b>9343PK</b>  | 1/4" (6.30mm) Hole Size<br>1 3/32" Stem Length<br>11/16" Flange Diameter<br>Black Nylon<br>Phillips Screw Retainers<br>Ford # N807577-S, N808331-S   | <b>15 Pcs.</b> |  |  |
| <b>15838PK</b> | 9/32" (7mm) Hole Size<br>10mm Stem Length<br>13mm Flange Diameter<br>Black Nylon Front Fender<br>Screw Type Retainers<br>Ford # W707365-S300   | <b>10 Pcs.</b> |  |  |
| <b>11918PK</b> | 9/32" (7mm) Hole Size<br>30.50mm Stem Length<br>12.70mm Head Diameter<br>Black Nylon<br>Phillips Screw Retainers<br>G.M. # 10195515<br>Ford # N805026S<br>Chrysler # 4696488   | <b>25 Pcs.</b> |  |  |



# Ford

## Retainers Phillips Screw

|                |   |                |  |   |
|----------------|---|----------------|--|---|
| <b>9287PK</b>  | 5/16" (8mm) Hole Size<br>12mm Stem Length<br>18mm Flange Diameter<br>Black Nylon<br>Phillips Screw Retainers<br>Ford # MB-455-56143<br>Hyundai # 86590-28000<br>Mazda # B092-51-833           | <b>10 Pcs.</b> |    |    |
| <b>10914PK</b> | 5/16" (8mm) Hole Size<br>18mm Stem Length<br>13mm Flange Diameter<br>Black Nylon Bumper<br>Phillips Screw Retainers<br>Ford # W713445-S300  | <b>15 Pcs.</b> |    |    |
| <b>11338PK</b> | 5/16" (8mm) Hole Size<br>18mm Stem Length<br>18mm Flange Diameter<br>Black Nylon<br>Bumper Retainers<br>Phillips Screw Type Retainers<br>Ford # W706494-S300                                  | <b>25 Pcs.</b> |    |    |
| <b>13226PK</b> | 5/16" (8mm) Hole Size<br>18mm Stem Length<br>18mm Flange Diameter<br>Black Nylon<br>Bumper Retainers<br>Phillips Screw Retainers<br>Ford # W710250-S300                                       | <b>25 Pcs.</b> |    |    |
| <b>15009PK</b> | 5/16" (8mm) Hole Size<br>18mm Stem Length<br>18mm Flange Diameter<br>Black Nylon<br>Phillips Screw Retainers<br>Ford # W706713-S300   | <b>25 Pcs.</b> |   |   |
| <b>5901PK</b>  | 5/16" (8mm) Hole Size<br>18mm Stem Length<br>20mm Flange Diameter<br>Black Nylon Inside Fender<br>Phillips Screw Retainers<br>Ford # MNA01-56145, NA01-56145<br>Nissan # 63844-01A00          | <b>25 Pcs.</b> |  |  |
| <b>5900PK</b>  | 5/16" (8mm) Hole Size<br>18mm Stem Length<br>20mm Flange Diameter<br>Black Nylon Inside Fender<br>Phillips Screw Retainers<br>Ford # NA01-56145<br>KIA # MNA01-56-145<br>Nissan # 63844-01A00 | <b>25 Pcs.</b> |  |  |
| <b>9600PK</b>  | 25/64" (10mm) Hole Size<br>11mm Stem Length<br>20.00 x 30.00mm Head Diameter<br>Nylon<br>Phillips Screw Retainers<br>Ford# E7ZG-17A904-B<br>Mazda# BF67-50-033                                | <b>10 Pcs.</b> |  |  |

# Ford

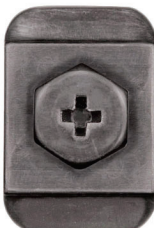
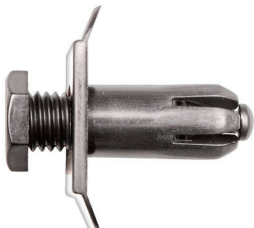

## Retainers Phillips Screw

|               |   |                |   |   |
|---------------|---|----------------|---|---|
| <b>1998PK</b> | 25/64" (10mm) Hole Size<br>18mm Stem Length<br>20.00 x 30.00mm Flange Size<br>Black Nylon Bumper Cover<br>Phillips Screw Retainers<br>Ford # E7GZ-17A904-G<br>Mazda # BF82-50-233, MBF82-50-233<br>Nissan # 01553-01393 | <b>10 Pcs.</b> |  |  |
|---------------|---|----------------|---|---|

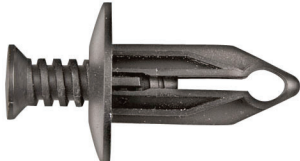

|                |  |                |   |   |
|----------------|--|----------------|---|---|
| <b>10043PK</b> | 25/64" (10mm) Hole Size<br>20mm Stem Length<br>20.00 x 30.00mm Flange Size<br>Black Nylon Bumper Cover<br>Phillips Screw Retainers<br>Ford # E92Z-17C756C<br>Mazda # GJ21-50-034 | <b>10 Pcs.</b> |  |  |
|----------------|--|----------------|---|---|

|                |   |                |   |   |
|----------------|---|----------------|---|---|
| <b>11138PK</b> | 13/32" (10.30mm) Hole Size<br>1" Stem Length<br>27/32" Flange Diameter<br>Black Nylon<br>Phillips Screw Retainers<br>G.M. # 11561353, 15672330, 15956470<br>Ford # W708325-S300 | <b>25 Pcs.</b> |  |  |
|----------------|---|----------------|---|---|



## Retainers Torx Screw Type

|                |   |                |  |  |
|----------------|---|----------------|--|--|
| <b>11234PK</b> | 15/64" (6mm) Hole Size<br>18mm Stem Length<br>11mm Flange Diameter<br>Black Nylon<br>Torx Screw Type Retainers<br>G.M. # 10089262, 21042098<br>Ford # W713134-S300<br>Chrysler # 55075139 | <b>25 Pcs.</b> |  |  |
|----------------|---|----------------|--|--|

## Clips Door Rod End

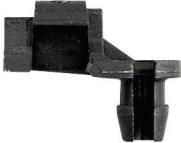
|               |   |                |  |   |
|---------------|---|----------------|--|---|
| <b>9725PK</b> | 5/32" Rod Size<br>17/64" Hole Size<br>Right Hand Side<br>Natural Nylon<br>Door Rod & Hood Clips<br>AMC # 4003672<br>G.M. # 16627328<br>Ford # N805350S<br>Chrysler # 2945108, 4658676 | <b>20 Pcs.</b> |  |  |
|---------------|---|----------------|--|---|

|               |   |                |   |   |
|---------------|---|----------------|---|---|
| <b>9726PK</b> | 5/32" Rod Size<br>17/64" Hole Size<br>Left Hand Side<br>Black Nylon<br>Door Rod & Hood Clips<br>AMC # 4003673<br>G.M. # 9815325, 16607593<br>Ford # N804344S, D2VZ-652195A<br>Chrysler # 2945109, 4658677 | <b>50 Pcs.</b> |  |  |
|---------------|---|----------------|---|---|

|               |   |                |   |   |
|---------------|---|----------------|---|---|
| <b>9728PK</b> | 5/32" Rod Size<br>17/64" Hole Size<br>Left Hand Side<br>Yellow Nylon<br>Door Lock Rod Clips<br>Ford # E6AZ-5421952-A, 390523S | <b>25 Pcs.</b> |  |  |
|---------------|---|----------------|---|---|

# Ford

## Clips Door Rod End

|               |   |                |  |
|---------------|---|----------------|--|
| <b>9729PK</b> | 5/32" Rod Size<br>17/64" Hole Size<br>Right Hand Side<br>Natural Nylon<br>Door Lock Rod Clips<br>Ford # 390522S | <b>25 Pcs.</b> |  |
|---------------|---|----------------|--|

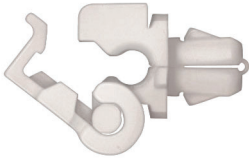
|                |  |                |   |
|----------------|--|----------------|---|
| <b>10078PK</b> | 10-24 Rod Size<br>8mm Hole Size<br>Fold Over Type<br>White Nylon<br>Door Lock Rod Clips<br>Ford # E6DZ-5421952A, E82Z-5421952B | <b>10 Pcs.</b> |  |
|----------------|--|----------------|---|

## Clips Tailgate Lock Rod End

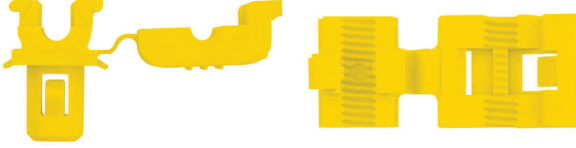
|               |   |                |  |
|---------------|---|----------------|--|
| <b>9981PK</b> | 10-24 Rod Size<br>8mm Hole Size<br>2mm Panel Range<br>Yellow Nylon<br>Door Lock & Tailgate Rod Clips<br>G.M. # 16629990, #16675980<br>Ford # F65Z-1521952-AA,<br>F7DZ-7421952-A | <b>15 Pcs.</b> |  |
|---------------|---|----------------|--|

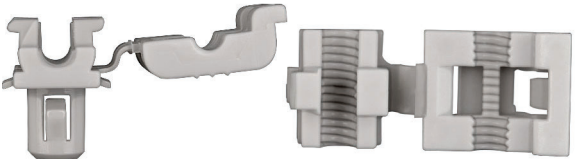
|                |   |                |  |
|----------------|---|----------------|--|
| <b>16391PK</b> | 10-24 Rod Size<br>2mm Panel Range<br>8mm Hole Size<br>Gray Nylon<br>Door Lock & Tailgate Rod Clips<br>Ford # F65Z-1521952-AA,<br>F7DZ-7421952-AA<br>G.M. # 16629990, 16675980, 16640343 | <b>15 Pcs.</b> |  |
|----------------|---|----------------|--|

## Retainers Door Trim Panel

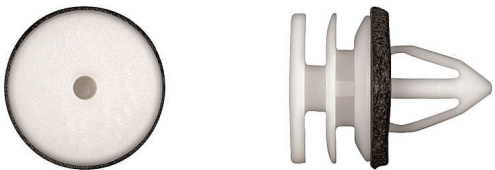
|                |  |                |  |
|----------------|--|----------------|--|
| <b>10701PK</b> | 3/8" (9.50mm) Hole Size<br>17mm Stem Length<br>19.50mm Top Head Diameter<br>White Nylon With Sealer<br>Door Trim Panel Retainers<br>Ford # W711521-S300<br>G.M. # 11519031 | <b>15 Pcs.</b> |  |
|----------------|--|----------------|--|

|                |  |                |  |
|----------------|--|----------------|--|
| <b>16061PK</b> | 6mm (15/64") Hole Size<br>9mm Stem Length<br>12.50mm Head Diameter<br>Black Nylon Bumper &<br>Mud Guard Retainers<br>Ford # W718046-S300 | <b>25 Pcs.</b> |  |
|----------------|--|----------------|--|

|                |   |                |  |
|----------------|---|----------------|--|
| <b>10544PK</b> | 9/32" (7mm) Hole Size<br>13mm Stem Length<br>15mm Top Head Diameter<br>White Nylon<br>Door Trim Panel Retainers<br>Ford # W701971-S | <b>25 Pcs.</b> |  |
|----------------|---|----------------|--|











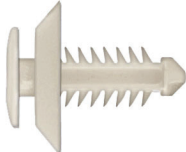

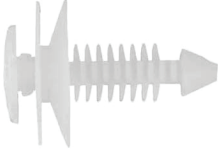

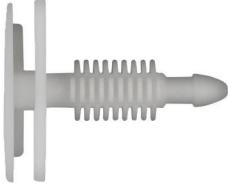

|               |   |                |  |
|---------------|---|----------------|--|
| <b>2112PK</b> | 9/32" (7mm) Hole Size<br>19mm Stem Length<br>12.50mm Top Head Diameter<br>Black Nylon<br>Door Trim Panel Retainers<br>Ford # N805155-S<br>Chrysler # 6505878AA, 6502709 | <b>50 Pcs.</b> |  |
|---------------|---|----------------|--|

|               |   |                |  |
|---------------|---|----------------|--|
| <b>9224PK</b> | 9/32" (7mm) Hole Size<br>19mm Stem Length<br>13.20mm Top Head Diameter<br>Natural Nylon<br>Door Trim Panel Retainers<br>G.M. # 21042045, 21042053, 21042058,<br>21042104<br>Ford # W707741-S300 | <b>50 Pcs.</b> |  |
|---------------|---|----------------|--|

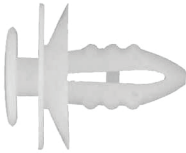
19





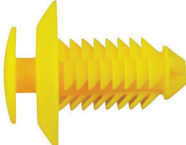





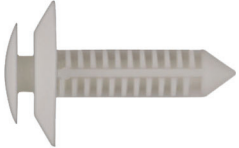



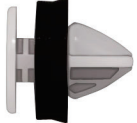

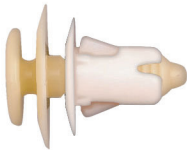
# Ford

## Retainers Door Trim Panel

|                |   |                |   |   |
|----------------|---|----------------|---|---|
| <b>1558PK</b>  | 9/32" (7mm) Hole Size<br>19mm Stem Length<br>13.30mm Top Head Diameter<br>Natural Nylon<br>Door Trim Panel Retainers<br>G.M. # 21042958<br>Ford # N802900 | <b>25 Pcs.</b> |    |                |
| <b>9514PK</b>  | 9/32" (7mm) Hole Size<br>22mm Stem Length<br>13mm Top Head Diameter<br>Natural Nylon<br>Door Trim Panel Retainers<br>Ford # 389144-S                      | <b>50 Pcs.</b> |    |                |
| <b>1648PK</b>  | 9/32" (7mm) Hole Size<br>24mm Stem Length<br>20mm Top Head Diameter<br>White Nylon<br>Door Trim Panel Retainers<br>G.M. # 12084605<br>Ford # 387496-S     | <b>25 Pcs.</b> |     |                |
| <b>16083PK</b> | 9/32" (7mm) Hole Size<br>45mm Stem Length<br>18mm Head Diameter<br>Black Nylon<br>Trim Panel Retainers<br>Ford # W719084-S300                             | <b>25 Pcs.</b> |    |                |
| <b>12518PK</b> | 5/16" (8mm) Hole Size<br>12mm Stem Length<br>13mm Top Head Diameter<br>Black and Blue<br>Door Trim Panel Retainers<br>Ford # W711037-S300                 | <b>25 Pcs.</b> |   |               |
| <b>9372PK</b>  | 5/16" (8mm) Hole Size<br>21/32" Stem Length<br>1/2" Top Head Diameter<br>White Nylon<br>Door Trim Panel Retainers<br>Ford # 387477-S                      | <b>50 Pcs.</b> |  |              |
| <b>16060PK</b> | 5/16" (8mm) Hole Size<br>17mm Stem Length<br>20mm Head Diameter<br>Black Nylon Fender, Bumper &<br>Interior Trim Retainers<br>Ford # W715926-S300         | <b>25 Pcs.</b> |  |  <b>NEW!</b> |
| <b>1575PK</b>  | 5/16" (8mm) Hole Size<br>19mm Stem Length<br>12.70mm Top Head Diameter<br>Black Nylon<br>Door Trim Panel Retainers<br>Ford # N801925-S, N802900-S         | <b>25 Pcs.</b> |  |              |
| <b>12886PK</b> | 5/16" (8mm) Hole Size<br>3/4" Stem Length<br>1/2" Top Head Diameter<br>Yellow Nylon<br>Door Trim Panel Retainers<br>Ford # F58Z-16237A02-A                | <b>25 Pcs.</b> |  |              |



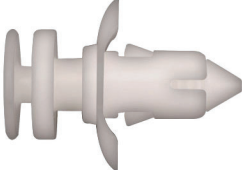

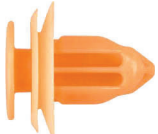

# Ford

## Retainers Door Trim Panel



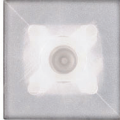



|                |  |                |  |   |
|----------------|--|----------------|--|---|
| <b>1742PK</b>  | 5/16" (8mm) Hole Size<br>1" Stem Length<br>1/2" Top Head Diameter<br>Natural Nylon<br>Door Trim Panel Retainers<br>G.M. # 10143422<br>Ford # N805612-S100, N805612-S<br>AMC # 893202-599, 8934-202-599 | <b>50 Pcs.</b> |    |    |
| <b>9021PK</b>  | 5/16" (8mm) Hole Size<br>1 1/8" Stem Length<br>1/2" Top Head Diameter<br>Black Nylon<br>Back Seat Door Trim Panel Retainers<br>Ford # 387182-S   | <b>25 Pcs.</b> |    |    |
| <b>9677PK</b>  | 21/64" (8.50mm) Hole Size<br>12mm Stem Length<br>14.50mm Top Head Diameter<br>White Nylon With Sealer<br>Front & Rear Door, Body Side &<br>Wheel Opening Moulding Retainers<br>Ford # W716507-S300     | <b>15 Pcs.</b> |    |    |
| <b>11907PK</b> | 21/64" (8.50mm) Hole Size<br>16mm Stem Length<br>20mm Flange Diameter<br>Caramel & Natural<br>Trim Panel Retainers<br>Ford # W708621-S300  | <b>25 Pcs.</b> |    |    |
| <b>10612PK</b> | 23/64" (9mm) Hole Size<br>17mm Stem Length<br>16mm Top Head Diameter<br>White Nylon With Sealer<br>Door Trim Panel Retainers<br>Ford # W713297-S300  | <b>25 Pcs.</b> |   |   |
| <b>10667PK</b> | 23/64" (9mm) Hole Size<br>19.50mm Stem Length<br>15mm Top Head Diameter<br>Natural Nylon<br>Door Trim Panel Retainers<br>Ford # 1W6Z-238A90-AA   | <b>25 Pcs.</b> |  |  |
| <b>2108PK</b>  | 3/8" (9.50mm) Hole Size<br>14mm Stem Length<br>15mm Top Head Diameter<br>White Nylon<br>Door Trim Panel Retainers<br>Chrysler # 6505292AA<br>Ford # W706812S300  | <b>25 Pcs.</b> |  |  |
| <b>13428PK</b> | 3/8" (9.50mm) Hole Size<br>17.50mm Stem Length<br>15mm Top Head Diameter<br>White Nylon Rear<br>Door Trim Panel Retainers<br>Ford # W704958-S300   | <b>25 Pcs.</b> |  |  |
| <b>11125PK</b> | 21/64" (8.50mm) Hole Size<br>14mm Stem Length<br>13mm Top Head Diameter<br>Orange Nylon<br>Rear Liftgate Retainers<br>Ford # W718230-S300<br>Honda # 91560-S6A-003                                     | <b>15 Pcs.</b> |  |  |

# Ford

## Retainers Door Trim Panel

|                |  |                |   |   |
|----------------|--|----------------|---|---|
| <b>13217PK</b> | 25/64" (10mm) Hole Size<br>14mm Stem Length<br>15mm Top Head Diameter<br>Green Nylon Lift Gate<br>Door Trim Panel Retainers<br>Ford # W709995-S300                                   | <b>25 Pcs.</b> |  |  |
| <b>17066PK</b> | 23/64" (9mm) Square Hole Size<br>20mm Stem Length<br>15.00 x 15.00mm Head Size<br>White Nylon With Sealer<br>Door Trim Panel Grommets<br>Chrysler # 6507009AA<br>Ford # W712990-S300 | <b>25 Pcs.</b> |  |  |
| <b>18801PK</b> | 12mm Width<br>18.30mm Height<br>Silver Finish<br>Interior Trim Fasteners<br>Ford # W714113-S439  | <b>50 Pcs.</b> |  |  |

## Retainers Door Trim Panel Wire Type

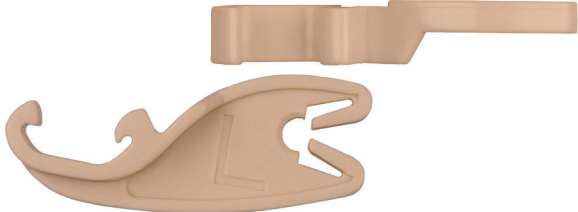

|               |  |                 |   |   |
|---------------|--|-----------------|---|---|
| <b>9876PK</b> | For Thin Panels<br>Short Leg Type<br>Wire Type Trim Panel Retainers<br>Ford # 351050-S3              | <b>100 Pcs.</b> |    |    |
| <b>578PK</b>  | For Thin Panels<br>Wire Type<br>Trim Panel Retainers<br>Ford # 358470<br>Chrysler # 1900654, 6002823 | <b>100 Pcs.</b> |   |   |
| <b>577PK</b>  | For Thick Panels<br>Wire Type<br>Trim Panel Retainers<br>Ford # 383033-S101                          | <b>100 Pcs.</b> |  |  |

## Pawls Door Lock

|                |   |                |  |  |
|----------------|---|----------------|--|--|
| <b>12506PK</b> | Left Hand Side<br>Beige Nylon<br>Door Lock Pawls<br>Ford # E6DZ-5421971-A, F3LY-6321971A  | <b>10 Pcs.</b> |  |  |
| <b>12507PK</b> | Right Hand Side<br>Pink Nylon<br>Door Lock Pawls<br>Ford # E6DZ-5421970-A, F3LY-6321970-A | <b>10 Pcs.</b> |  |  |

# Ford

## Bushings Door Hinge Pin

**1267PK** .345" Inside Diameter  
.419" Outside Diameter  
.295" Height  
Door Hinge Pin Bushings  
G.M. # 9721917  
Ford # D1AZ-6522841A **25 Pcs.**  

**1270PK** .348" Inside Diameter  
.479" Outside Diameter  
.296" Height  
Door Hinge Pin Bushings  
Ford # D90Z-6522841A **25 Pcs.**  



## Pins Door Hinge





**9595PK** 3 3/8" Length  
11/32" Pin Diameter  
9/16" Head Outside Diameter  
Door Hinge Pins  
Ford # D9ZZ-6643030-AA **10 Pcs.**





**9937PK** 3 1/2" Length  
11/32" Pin Diameter  
9/16" Head Outside Diameter  
Ford Ranger, F150, F250 & F350  
Door Hinge Pins  
Ford # E8UZ1522840 **5 Pcs.**

**12319PK** .275" Outside Diameter  
1.26" Length  
Front & Rear  
Black Finish  
Door Hinge Pins  
Ford 82-07, Lincoln 88-06,  
Mercury 82-05 **5 Pcs.**  

## Rollers Door Hinge Pin

**12318PK** .887" Outside Diameter  
.290" Inside Diameter  
.530" Thickness  
Front & Rear  
White Plastic  
Door Hinge Rollers  
Ford # E2FZ-5823519-A  
Ford 82-07, Lincoln 88-06, Mercury 82-05 **5 Pcs.**  

## Kits Door Hinge Pin Roller

**12320** Front & Rear  
.887" White Roller  
1.26" Black Pin  
Door Hinge Roller Kit  
Ford 82-07, Lincoln 88-06, Mercury 82-05 **1 Pc.**  

19

# Ford

## Kits Door Hinge Pin & Bushing

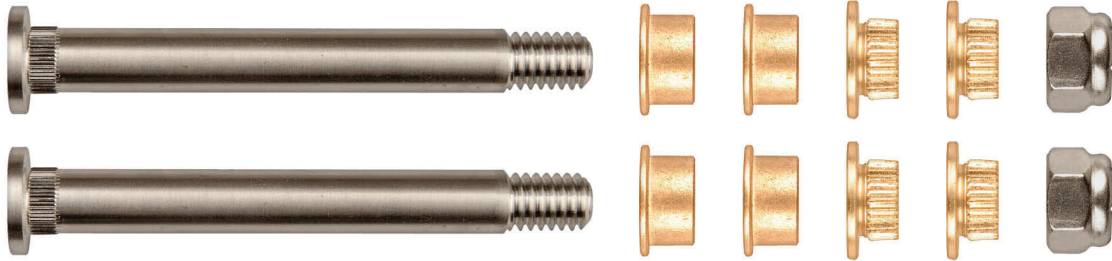

**12119**

Will Repair Front Door  
Upper & Lower Hinge  
Stainless Steel Pins & Nuts  
Door Hinge Pin &  
Bushings Bracket Repair Kit  
Ford Aerostar 86-97,  
Ford Crown Victoria 82-09,  
Ford E-150, Ford E-250, Ford E-350 92-98,  
Ford Econoline Cargo & Wagon 99-09,  
Ford Explorer 91-05,  
Ford Explorer Sport 01-03,  
Ford Explorer Sport Trac 01-05,  
Ford Freestar 04-07, Ford Mustang 94-04,  
& Ford Mustang SVT Cobra 94-04

**1 Kit**

## Retainers Headlight

**1864PK**

Zinc Finish  
Headlight Component  
Retaining Clips  
Ford # E9DB-13N020AA, E9DZ-13N129A,  
F2AB-13N020-AA

**25 Pcs.**

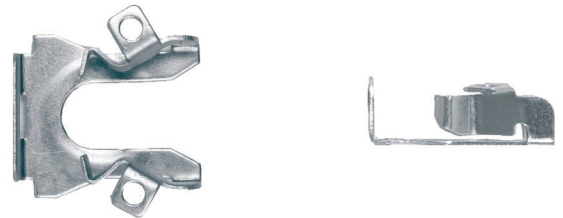

## Retainers Rearlight

**10204PK**

5/16" (8mm) Square Hole Size  
12mm Stem Length  
15mm Top Head Diameter  
White Nylon With Sealer  
Tail Light Mounting Retainers  
Ford # W713579-S300

**10 Pcs.**



**9720PK**

Rear Light Assembly Retainers  
Chrysler # 6502776  
Ford # N806624-S191

**25 Pcs.**



## Block Setting

**18878PK**

30.50mm Width  
38.50mm Length  
33.70mm Overall Height  
Black Nylon With Sealer  
Windshield Setting Block  
Ford # 9L3Z-14060A12-A,  
4L3Z-1503296-AB

**5 Pcs.**

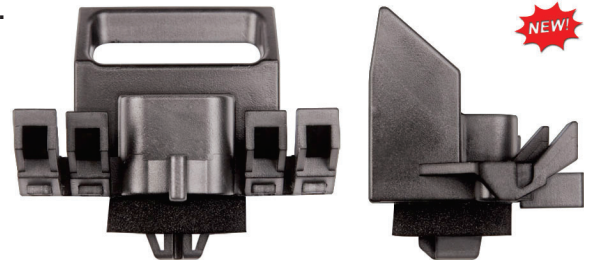

# Ford











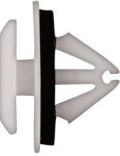

## Retainers Moulding

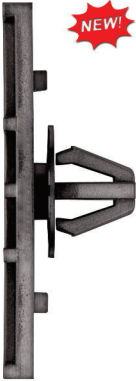
|                |   |                |  |  |
|----------------|---|----------------|--|--|
| <b>18848PK</b> | 3/16 (5mm) Hole Size<br>8mm Stem Length<br>10mm Top Head Diameter<br>White Nylon<br>Window Moulding Retainers<br>Ford # W70901 1-S300                             | <b>25 Pcs.</b> |  |  |
| <b>18314PK</b> | 6 x 10mm Slot Size<br>11mm Stem Length<br>12.00 x 14.00mm Top Head Size<br>White Nylon with Sealer<br>"B" Pillar Moulding Retainers                               | <b>15 Pcs.</b> |  |  |
| <b>14958PK</b> | 9/32" (7mm) Hole Size<br>9mm Stem Length<br>13.00 x 13.50mm Top Head Diameter<br>Black & White Nylon With Sealer<br>Windshield Moulding Clips<br>Ford # N.A.      | <b>10 Pcs.</b> |  |  |
| <b>12513PK</b> | 9/32" (7mm) Hole Size<br>43mm Stem Length<br>18mm Head Diameter<br>10.50 - 37.50mm Panel Range<br>Black Nylon<br>Rocker Moulding Retainers<br>Ford # W710532-S300 | <b>25 Pcs.</b> |  |  |
| <b>11387PK</b> | 5/16" (8mm) Hole Size<br>15/32" Stem Length<br>3/4" Flange Diameter<br>White Nylon<br>Exterior Moulding Retainers<br>Ford   | <b>10 Pcs.</b> |  |  |
| <b>2161PK</b>  | 5/16" (8mm) Hole Size<br>11/16" Stem Length<br>9/16" x 2" Top Head Diameter<br>Black Nylon<br>Rocker Panel Moulding Clips<br>Ford # F1TZ-7810182-A                | <b>25 Pcs.</b> |  |  |
| <b>18313PK</b> | 8 x 12mm Slot<br>15mm Stem Length<br>11.00 x 15.00mm Top Head Size<br>White Nylon with Sealer<br>Bumper Side Extension Retainer<br>Ford # W719957-S300            | <b>10 Pcs.</b> |  |  |
| <b>13209PK</b> | 23/64" (9mm) Hole Size<br>10mm Stem Length<br>14.00 x 18.00mm Top Head Diameter<br>Blue Nylon Windshield<br>Moulding Clips With Sealer<br>Ford # W790173-S900     | <b>10 Pcs.</b> |  |  |

19

# Ford

## Retainers Moulding

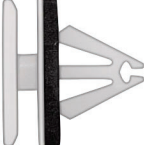
|                |  |                |   |   |
|----------------|--|----------------|---|---|
| <b>10913PK</b> | 23/64" (9mm) Hole Size<br>11mm Stem Length<br>14.00 x 18.00mm Top Head Size<br>White Nylon With Sealer<br>Windshield Moulding Clips<br>Ford # W713590-S300           | <b>15 Pcs.</b> |    |    |
| <b>12896PK</b> | 23/64" (9mm) Hole Size<br>11mm Stem Length<br>15.00 x 20.00mm Top Head Diameter<br>White Nylon With Sealer<br>Moulding Retainers<br>Ford # W716237-S300              | <b>15 Pcs.</b> |     |    |
| <b>18786PK</b> | 23/64" (9mm) Hole Size<br>11mm Stem Length<br>15.00 x 50.00mm Head Size<br>Black Nylon<br>Rocker Panel Moulding Retainers<br>Ford # W716878-S300                     | <b>25 Pcs.</b> |    |    |
| <b>13387PK</b> | 23/64" (9mm) Hole Size<br>12mm Stem Length<br>14.00 x 20.00mm Top Head Diameter<br>White Nylon With Sealer<br>Moulding Retainers<br>Ford # W710528-S300              | <b>15 Pcs.</b> |   |   |
| <b>15078PK</b> | 23/64" (9mm) Hole Size<br>12mm Stem Length<br>16.00 x 23.00mm Top Head Diameter<br>Gray Nylon<br>Fender Corner & Rocker<br>Moulding Clips<br>Ford # W790225-S900     | <b>10 Pcs.</b> |  |  |
| <b>18788PK</b> | 23/64" (9mm) Hole Size<br>14mm Stem Length<br>12.00 x 16.00mm Head Size<br>White Nylon With Sealer<br>Exterior Moulding Retainers<br>Ford # W719971-S300             | <b>25 Pcs.</b> |  |  |
| <b>13090PK</b> | 23/64" (9mm) Hole Size<br>14mm Stem Length<br>12.00 x 20.00mm Top Head Diameter<br>White Nylon With Sealer<br>Rocker Panel Moulding Retainers<br>Ford # W716352-S300 | <b>25 Pcs.</b> |  |  |

# Ford

## Retainers Moulding

|                |  |                |  |  |
|----------------|--|----------------|--|--|
| <b>12545PK</b> | 23/64" (9mm) Hole Size<br>14mm Stem Length<br>13.00 x 39.00mm Top Head Diameter<br>Black Nylon<br>Fender Flare & Rocker Moulding Clips<br>Ford # F6DZ-5410182-AA | <b>10 Pcs.</b> |  |  |
| <b>14959PK</b> | 23/64" (9mm) Hole Size<br>14mm Stem Length<br>15.00 x 20.00mm Top Head Diameter<br>White Nylon With Sealer<br>Rocker Panel Moulding Clips<br>Ford # W716503-S300 | <b>25 Pcs.</b> |  |  |
| <b>12986PK</b> | 23/64" (9mm) Hole Size<br>14mm Stem Length<br>16.00 x 50.00mm Head Diameter<br>Black Nylon<br>Rocker Panel Moulding Clips<br>Ford # F4ZZ-6310182-A               | <b>15 Pcs.</b> |  |  |
| <b>12041PK</b> | 23/64" (9mm) Hole Size<br>14mm Stem Length<br>20.00 x 40.00mm Head Diameter<br>White Nylon<br>Ground Effects Moulding Clips<br>Ford                              | <b>10 Pcs.</b> |  |  |
| <b>14957PK</b> | 23/64" (9mm) Hole Size<br>15mm Stem Length<br>14.00 x 18.00mm Top Head Size<br>Gray Nylon With Sealer<br>Fender & Rocker Moulding Clips<br>Ford # N/A            | <b>25 Pcs.</b> |  |  |
| <b>18888PK</b> | 11/32" (9mm) Hole Size<br>16mm Stem Length<br>12.00 x 20.00mm Top Head Size<br>Gray Nylon With Sealer<br>Bumper Moulding Retainers<br>Ford # W716497-S300        | <b>10 Pcs.</b> |  |  |

19













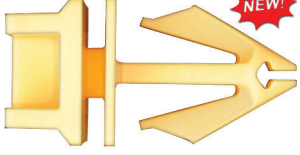

# Ford

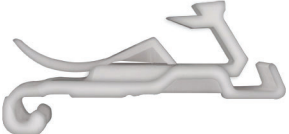
## Retainers Moulding

|                |   |                |   |   |
|----------------|---|----------------|---|---|
| <b>15304PK</b> | 23/64" (9mm) Hole Size<br>16mm Stem Length<br>14.00 x 18.00mm Top Head Diameter<br>White Nylon With Sealer<br>Rocker Panel Moulding Clips<br>Ford # N/A       | <b>10 Pcs.</b> |     |    |
| <b>13095PK</b> | 23/64" (9mm) Hole Size<br>18mm Stem Length<br>14.00 x 20.00mm Top Head Diameter<br>White Nylon<br>Wheel Opening Moulding Clips<br>Ford W717736-S300           | <b>10 Pcs.</b> |     |    |
| <b>15943PK</b> | 3/8" (9.50mm) Hole Size<br>14mm Stem Length<br>13mm Top Head Diameter<br>Black Nylon With Sealer<br>Rear Bumper Retainers<br>Ford # W718033-S300              | <b>10 Pcs.</b> |    |    |
| <b>18889PK</b> | "11/32" (9mm) Hole Size<br>18mm Stem Length<br>14.00 x 20.00mm Top Head Size<br>White Nylon With Sealer<br>Liftgate Moulding Retainers<br>Ford # W716646-S300 | <b>10 Pcs.</b> |    |   |
| <b>15015PK</b> | 3/8" (9.50mm) Hole Size<br>11mm Stem Length<br>14.00 x 40.00mm Head Size<br>Black Nylon<br>Rocker Moulding Retainers<br>Ford # F57Z-16241-AB, W709767-S300    | <b>15 Pcs.</b> |  |  |
| <b>16396PK</b> | 25/64" (10mm) Hole Size<br>11mm Stem Length<br>11.00 x 20.00mm Head Size<br>White Nylon<br>Moulding Retainers<br>Ford # W716460-S300                          | <b>25 Pcs.</b> |  |  |
| <b>10066PK</b> | 25/64" (10mm) Hole Size<br>12mm Stem Length<br>20mm Head Diameter<br>Black Nylon<br>Radiator Shroud Retainers<br>Ford # W708771-S300                          | <b>50 Pcs.</b> |   |  |

# Ford

## Retainers Moulding

|                |   |                |  |   |
|----------------|---|----------------|--|---|
| <b>14955PK</b> | 25/64" (10mm) Hole Size<br>15mm Stem Length<br>12.00 x 20.00mm Top Head Diameter<br>White Nylon With Sealer<br>Rocker Panel Moulding Clips<br>Ford # W715201-S300                 | <b>15 Pcs.</b> |    |    |
| <b>18785PK</b> | 25/64" (10mm) Hole Size<br>18mm Stem Length<br>14.00 x 20.00mm Top Head Size<br>Yellow Nylon<br>Wheel Opening Moulding Retainers<br>Ford # W790383-S900                           | <b>25 Pcs.</b> |    |    |
| <b>12919PK</b> | 5/16 x 1/2" Hole Size<br>3/8" Stem Length<br>1/2 x 13/16" Head Diameter<br>White Nylon With Sealer<br>Front End Moulding Retainers<br>Ford # W705849-S300<br>Mazda # 9XG0-73-88X0 | <b>10 Pcs.</b> |    |    |
| <b>9663PK</b>  | 18mm Wide<br>37mm Length<br>White Nylon<br>Belt Moulding Clips<br>Ford # N/A  | <b>10 Pcs.</b> |    |    |
| <b>11902PK</b> | 18.50mm Width<br>34.50mm Length<br>White Nylon<br>Door Belt<br>Moulding Clips<br>Ford # N/A   | <b>15 Pcs.</b> |   |   |
| <b>10629PK</b> | 11.00 x 16.00mm Head Size<br>19mm Length<br>Gray Nylon<br>Rocker Panel Moulding Clips<br>Ford # 6G1Z-5410182-D  | <b>25 Pcs.</b> |  |  |
| <b>10691PK</b> | 42mm From Tip to Tip<br>12mm Front To Back<br>21mm Height<br>Black Nylon<br>Roof & Garnish Moulding Clips<br>Ford # 4L3Z-1510182-AA   | <b>15 Pcs.</b> |  |  |
| <b>10742PK</b> | 4.00 x 9.00mm Hole Size<br>11mm Stem Length<br>34mm Across the Top<br>White Nylon With Sealer<br>Drip Moulding Clips<br>Ford  | <b>15 Pcs.</b> |  |  |

19

# Ford

## Retainers Moulding

**12315PK** 22.00 x 30.00mm Head Diameter  
18mm Height  
9 x 20mm Slot Size  
Gray Nylon  
Rocker Panel Moulding Clips  
Ford # 6G1Z-5410182-A, W716350-S300



## Retainers Reveal Moulding

**1371PK** 14.50mm Width  
19.50mm Length  
Black Finish  
Windshield & Rear Glass  
Reveal Moulding Clips  
Ford # E3SB-6342413-AB,  
E3SZ-6342413-A



**12388PK** 17mm Width  
19.25mm Length  
Green Finish  
Windshield & Rear Window  
Reveal Moulding Clip  
Ford # C8AZ-63642413-A,  
D1AB-6542413-AB



**9545PK** 17.25mm Width  
19.50mm Length  
Black Finish  
Windshield & Rear Window  
Reveal Moulding Clips  
Ford # C8AZ-63642413-A,  
C8AZ-636442413-A,  
D1AZ-6542413-AB, D1AB-6542413-AB



**9874PK** 17.25mm Width  
20mm Length  
Black Finish  
Rear Window  
Reveal Moulding Clips  
Ford # C6AB-6242413-A



**9550PK** 18mm Width  
20.50mm Length  
Black Finish  
Windshield & Rear Window  
Reveal Moulding Clips  
Ford # C5ZZ-6543413-B,  
D1AZ-6542113-B,  
D1AB-6542413-AB



## Retainers Universal Moulding

**9879PK** 10-24 x 3/4" Screw Size  
1/2 x 1" Plate Size  
Universal  
Moulding Clips  
Chrysler # 1560058, 6010029  
G.M. # 568792, 574355, 1165051  
Ford # 358560



Not Acutal Size



**315PK** 13/16 x 2 1/8" Plate Size  
Universal  
Moulding Clips



Not Acutal Size



# Ford

## Window Regulator Left Front Clips

**13527PK**

Left Front Door  
Window Regulator Clip  
Ford Focus 1998 - On

1 Pc.



Not Actual Size

## Window Regulator Right Front Clips

**13528PK**

Right Front Door  
Window Regulator Clip  
Ford Focus 1998 - On

1 Pc.



Not Actual Size