

# Imports Toyota

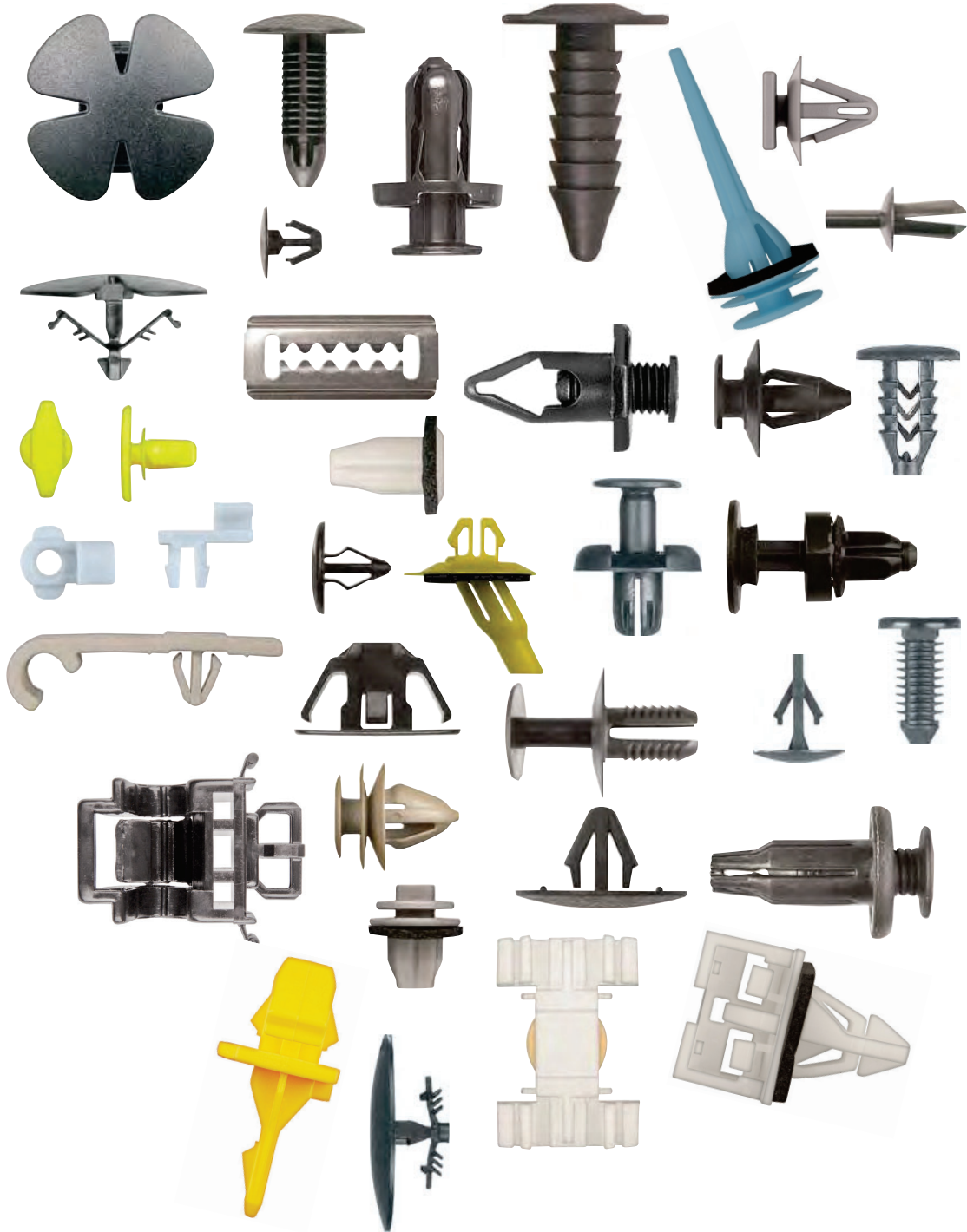

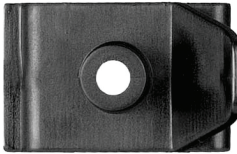

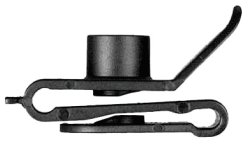
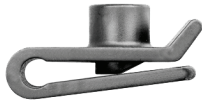
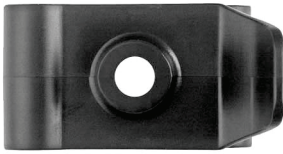
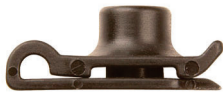
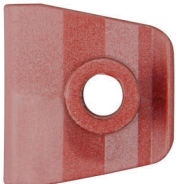
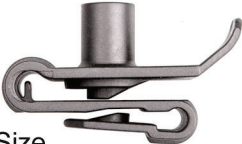

# Toyota

## Nuts Nylon "U" Type Metric

<b>1601PK</b>	#10 (4.80mm) Screw Size Up to 1mm Panel Range 11mm Center of Hole to Edge Black Nylon Fender Wheel Housing Type "U" Nuts G.M. # 94841226 Mazda LA01-56-135 Toyota # 53879-14010-A, 53879-14020, 53879-22030	<b>15 Pcs.</b>		
<b>12494PK</b>	#10 (4.80mm) Screw Size Up to 3mm Panel Range 14mm Center of Hole to Edge Black Nylon "U" Type Nuts Toyota # 90179-05060	<b>10 Pcs.</b>		
<b>11421PK</b>	#12 (5.50mm) Screw Size Up to 1.00mm Panel Range 14mm Center of Hole to Edge Black Nylon "U" Type Nuts Toyota # 90467-05114	<b>10 Pcs.</b>		
<b>1606PK</b>	#14 (6.30mm) Screw Size Up to 1.00mm Panel Range 15mm Center of Hole to Edge Black Nylon Fender Wheel Housing "U" Type Nuts Toyota # 53879-22010	<b>15 Pcs.</b>		
<b>11388PK</b>	#14 (6.30mm) Screw Size Up To 2mm Panel Range 12mm Center of Hole to Edge Dark Red Nylon Front Bumper "U" Type Nuts Toyota # 90467-A0018, 90467-05081, 90084-46019	<b>15 Pcs.</b>		
<b>15083PK</b>	#14 (6.30mm) Screw Size Up to 3mm Panel Range 14mm Center of Hole to Edge Black Nylon Front Bumper & Fender Liner "U" Type Nuts Toyota # 90467-05138	<b>15 Pcs.</b>		

Not Actual Size















## Nuts Nylon

<b>16473PK</b>	#6 (3.50mm) Screw Size 7mm Stem Length 10mm Head Size 7.00 x 7.00mm Hole Size White Nylon Screw Grommets Toyota # 81137-22530, 90075-10004, 81150-1A750	<b>25 Pcs.</b>		
<b>1978PK</b>	#6 (3.50mm) Screw Size 8mm Stem Length 12.00 x 16.00mm Head Size 6.00 x 10.00mm Hole Size Natural Nylon Screw Grommets Isuzu # 8941340270 Toyota # 90189-05012	<b>50 Pcs.</b>		

NEW!













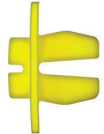

# Toyota

## Nuts Nylon

<b>9112PK</b>	#6 (3.50mm) Screw Size 8mm Stem Length 12mm Head Diameter 7.00 x 7.50mm Hole Size Natural Nylon Screw Grommets Toyota # 90189-04011, 90189-04057	<b>25 Pcs.</b>		
<b>9591PK</b>	#6 (3.50mm) Screw Size 10mm Stem Length 14mm Head Diameter 7mm Hole Size Natural Nylon With Sealer Screw Grommets Honda # 90662-693-0030, 90662-693-003, 90662-693-0031 Toyota # 90189-04066	<b>25 Pcs.</b>		
<b>1636PK</b>	#6 (3.50mm) Screw Size 15mm Stem Length 14.50mm Head Diameter 7mm Hole Size Natural Nylon Screw Grommets Honda # 90672-671-8110M1 Toyota # 90189-04013	<b>25 Pcs.</b>		
<b>1577PK</b>	#8 (4.20mm) Screw Size 6.50mm Stem Length 10mm Head Diameter 6.00 x 7.00mm Hole Size Natural Nylon Side Marker Light Screw Grommets Honda # 75522-611-000, 75522-611-0000 Mazda # 9991-00-412 Mitsubishi # MS-480001 Nissan # 96706-B0700, 97606-B0700 Toyota # 90189-04042, 95900-04036	<b>50 Pcs.</b>		
<b>12902PK</b>	#8 (4.20mm) Screw Size 7mm Stem Length 10mm Head Diameter 7mm Hole Size Natural Nylon Screw Grommets Toyota # 90189-04014	<b>50 Pcs.</b>		
<b>11143PK</b>	#8 (4.20mm) Screw Size 8mm Stem Length 17mm Head Diameter 9mm Hole Size Natural Nylon Headlight Mounting Nuts Toyota # 90189-05142	<b>25 Pcs.</b>		
<b>12725PK</b>	#8 (4.20mm) Screw Size 16mm Stem Length 12mm Head Diameter 10mm Hole Size Black Nylon Screw Grommets Mitsubishi # MB029111 Toyota # 90189-04008, 90467-12096, 94841130	<b>15 Pcs.</b>		

# Toyota

## Nuts Nylon

<b>1572PK</b>	#8 (4.20mm) Screw Size 17mm Stem Length 16mm Head Diameter 8mm Hole Size Natural Nylon Screw Grommets Honda # 90661-SC7-0030, 90661-SC7-003 Mazda # H001-50-841 Mitsubishi # MS-480012 Nissan # 01651-00481, 74798-S90000, 01281-00231 Toyota # 90189-06042	<b>25 Pcs.</b>		
<b>1610PK</b>	#10 (4.80mm) Screw Size 7mm Stem Length 14mm Head Diameter 9mm Hole Size Black Nylon Screw Grommets Toyota # 90189-06018	<b>25 Pcs.</b>		
<b>1614PK</b>	#10 (4.80mm) Screw Size 8mm Stem Length 13mm Head Diameter 8.50mm Hole Size Natural Nylon Screw Grommets Honda # 75521-611-0000, 91619-SA5-003 Mazda # 9991-00-601 Nissan # 96706-P0105 Toyota # 90189-06010	<b>25 Pcs.</b>		
<b>16399PK</b>	#10 (4.80mm) Screw Size 8mm Stem Length 17mm Head Diameter 23/64" (9mm) Hole Size Yellow Nylon Headlamp Assembly Grommet Toyota # 90189-06238	<b>25 Pcs.</b>		
<b>10659PK</b>	#10 (4.80mm) Screw Size 10mm Stem Length 16mm Head Diameter 9mm Hole Size Natural Nylon Screw Grommets Nissan # 01281-00111 Toyota # 90189-06006	<b>25 Pcs.</b>		
<b>18831PK</b>	6-1.00mm Thread Size 25/64" (10mm) Hole Size 18mm Flange Diameter 10mm Height Black Nylon Wheel Apron Thumb Drive Nuts Toyota # 90467-06169	<b>25 Pcs.</b>		
<b>1560PK</b>	#10 (4.80mm) Screw Size 11mm Stem Length 12mm Head Size 8.00 x 9.00mm Hole Size Natural Nylon Grille Screw Grommets G.M. # 94841764 Mitsubishi # MS480002, MS480009 Toyota # 90189-05013	<b>50 Pcs.</b>		
<b>1576PK</b>	#10 (4.80mm) Screw Size 17mm Stem Length 18mm Head Diameter 8.50mm Hole Diameter Natural Nylon Screw Grommets Mitsubishi # MB-098145 Nissan # 01281-00023, 01281-00231 Toyota # 90189-06001, 96706-U0100	<b>25 Pcs.</b>		

22

NEW!

# Toyota

## Nuts Nylon



<b>10745PK</b>	#12 (5.50-6mm) Screw Size 9mm Stem Length 17.00 x 30.00mm Head Diameter Black Nylon Front Bumper Screw Grommets Toyota # 52535-50060, 52535-0E010	<b>5 Pcs.</b>		
<b>10794PK</b>	#12 (5.50mm) Screw Size 10mm Stem Length 14.00 x 16.00mm Head Size 9.00 x 11.00mm Hole Size White Nylon Front Bumper Screw Grommets Toyota # 90189-06193, 90189-06237	<b>25 Pcs.</b>		
<b>12073PK</b>	#12 (5.50mm) Screw Size 10mm Stem Length 17mm Head Diameter 9mm Square Hole Size Black Nylon Rocker & Floor Screw Grommets Toyota # 90189-06211	<b>25 Pcs.</b>		
<b>10988PK</b>	#12 (5.50mm) Screw Size 9mm Hole Size 18mm Stem Length 16mm Head Diameter Black Nylon Fender Liner Screw Grommets Toyota # 90189-06214	<b>15 Pcs.</b>		
<b>9912PK</b>	#12 (5.50mm) Screw Size 8mm Square Hole Size 19mm Stem Length 16mm Head Diameter Black Nylon Front & Rear Wheel Fender Liner Screw Grommets Toyota # 90189-06028	<b>15 Pcs.</b>		
<b>15812PK</b>	#12 (5.50mm) Screw Size 9mm Square Hole Size 17mm Stem Length 20mm Head Diameter Black Nylon Screw Grommets Toyota # 90189-A0002	<b>25 Pcs.</b>		
<b>18164PK</b>	#12 (5.50mm) Screw Size 9mm Hole Diameter 17mm Stem Length 20mm Flange Diameter Black Nylon Fender Liner Screw Grommets Toyota # 90189-06236	<b>25 Pcs.</b>		
<b>16470PK</b>	#12 (5.50mm) Screw Size 17mm Stem Length 18mm Head Diameter 9mm Hole Size Natural Nylon With Sealer Rear Door Screw Grommets Hyundai # 86910-22000 Toyota # 90189-06029, 90189-06084, 90189-06116	<b>10 Pcs.</b>		 <b>NEW!</b>
<b>11389PK</b>	#12 (5.50mm) Screw Size 9mm Hole Size 18mm Stem Length 20mm Head Diameter Black Nylon Hood & Fender Screw Grommets Toyota # 90189-06065	<b>15 Pcs.</b>		

# Toyota

## Nuts Nylon









<b>9913PK</b>	#12 (5.50mm) Screw Size 8mm Square Hole Size 22mm Stem Length 20mm Head Diameter Black Nylon Fender Liner Screw Grommets Toyota # 90189-06157	<b>15 Pcs.</b>		
<b>12502PK</b>	#12 (5.50mm) Screw Size 22mm Stem Length 20mm Head Diameter 9mm Square Hole Size Black Nylon Rocker Moulding Screw Grommets Toyota # 90189-06177	<b>15 Pcs.</b>		
<b>1608PK</b>	#14 (6.30-1.81) Screw Size 8mm Hole Size 16mm Stem Length 18mm Head Diameter White Nylon Screw Grommets Toyota # 90189-06005	<b>50 Pcs.</b>		
<b>1605PK</b>	#14 (6.30mm) Screw Size 8mm Square Hole Size 17mm Stem Length 20mm Head Diameter Black Nylon Screw Grommets Toyota # 90189-06013, 96706-W100	<b>25 Pcs.</b>		
<b>13437PK</b>	#14 (6.30mm) Screw Size 16.00 x 18.00mm Head Size 19mm Stem Length Black Nylon Bumper Side Bracket Screw Grommets Toyota # 52197-22020	<b>15 Pcs.</b>		
<b>9079PK</b>	23/64" (9mm) Hole Size 15mm Stem Length 18mm Head Diameter White Nylon Front Fender Screw Grommets Toyota # 90189-06114	<b>15 Pcs.</b>		
<b>17086PK</b>	23/64" (9mm) Square Hole Size 17mm Stem Length 18mm Flange Size Yellow Nylon Bumper Cover W/Sealer Screw Grommets Toyota # 52188-33040	<b>25 Pcs.</b>		
<b>9712PK</b>	7/16" (11mm) Hole Size 9mm Stem Length 13mm Head Diameter White Nylon Park & Turn Signal Grommets Ford # N811169-S, W705550-S300 G.M. #10423331 Toyota # 90075-10801, 90189-06111	<b>50 Pcs.</b>		

## Products Rubber













<b>11395PK</b>	6.70mm Inside Diameter 20mm Outside Diameter 1.76mm Thickness Neoprene Bumper Washers Toyota # 90430-06003	<b>15 Pcs.</b>		
----------------	--	----------------	--	---

# Toyota

## Clips Retaining



















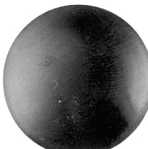

<b>15026PK</b>	9/32" (7mm) Hole Size 9mm Stem Length 20mm Flange Diameter Black Nylon With Sealer Front Fender Retainers Toyota # 83857-47011	<b>15 Pcs.</b>		
<b>12918PK</b>	3/16" (4.50mm) Hole Size 12mm Stem Length 16mm Head Diameter Black Nylon Front Bumper Bracket Shield Retainers Toyota # 90467-05125	<b>25 Pcs.</b>		
<b>15002PK</b>	15/64" (6mm) Hole Size 16mm Stem Length 16mm Head Diameter Black Nylon Luggage Compartment Shield Retainers Toyota # 90467-06175	<b>15 Pcs.</b>		
<b>12897PK</b>	1/4" (6.50mm) Hole Size 16mm Stem Length 16mm Head Diameter Black Nylon Luggage Compartment Trim Retainer Clips Toyota # 90467-08186	<b>25 Pcs.</b>		

## Retainers Shield

<b>18779PK</b>	13/64" (5mm) Hole Size 15mm Stem Length 20mm Head Diameter Tan Nylon Headliner Retainers Toyota # 90467-05164-E2	<b>25 Pcs.</b>		
<b>18348PK</b>	7/32" (5.50mm) Hole Size 14.90mm Stem Length 16mm Head Diameter Black Nylon Shield Retainers Toyota # 90467-A0001-C1	<b>50 Pcs.</b>		
<b>11021PK</b>	1/4" (6.35mm) Hole Size 16mm Stem Length 19mm Head Diameter 2.70 - 7.30mm Panel Range Black Nylon Bumper Cover Shield Retainers Toyota # 90467-A0008	<b>50 Pcs.</b>		
<b>18814PK</b>	13/64" (5mm) Hole Size 14.90mm Stem Length 16mm Head Diameter Black Nylon Trim Panel Retainers Toyota # 90467-05161-C0	<b>25 Pcs.</b>		
<b>11979PK</b>	5/16" (8mm) Hole Size 16mm Stem Length 16mm Head Diameter Black Nylon Fender Seal Retainers Toyota # 90467-07208	<b>25 Pcs.</b>		
<b>18799PK</b>	9/32" (7mm) Hole Size 16mm Stem Length 16mm Head Diameter Black Nylon Trunk Side Trim Retainers Toyota # 90467-A0002C4, 90467A0002C0	<b>25 Pcs.</b>		















# Toyota

## Clips Retaining

<b>9074PK</b>	13/64" (5mm) Hole Size 10mm Stem Length 14mm Head Diameter 3mm Panel Thickness Black Nylon Panel Retainers Toyota # 90467-06161-01	<b>25 Pcs.</b>		
<b>1996PK</b>	13/64" (5mm) Hole Size 11mm Stem Length 13mm Head Diameter Black Nylon Hood Seal Retaining Clips G.M. # 94842841, 94849113 Toyota # 90467-08004, 90467-08011	<b>50 Pcs.</b>		
<b>1466PK</b>	13/64" (5mm) Hole Size 15mm Stem Length 13mm Head Diameter Black Nylon Retaining Clips Nissan # 01553-00172 Toyota # 90467-07050, 90467-08008	<b>25 Pcs.</b>		
<b>13245PK</b>	15/64" (6mm) Hole Size 10mm Stem Length 16mm Head Diameter Black Nylon Side Trim Panel Retaining Clips Toyota # 90467-07096	<b>10 Pcs.</b>		
<b>9261PK</b>	1/4" (6.30mm) Hole Size 13mm Stem Length 7.00 x 13.00mm Head Size Black Nylon Hood Cowl Retaining Clips Toyota # 90467-08101	<b>25 Pcs.</b>		
<b>11417PK</b>	9/32" (7mm) Hole Size 8mm Stem Length 20mm Head Diameter Black Nylon Fender Seal Retaining Clips Toyota # 90467-08136	<b>25 Pcs.</b>		
<b>10416PK</b>	9/32" (7mm) Hole Size 20mm Stem Length 15mm Head Diameter Black Nylon Retaining Clips Honda # 90670-692-0030 Toyota # 90467-09065	<b>25 Pcs.</b>		
<b>11975PK</b>	5/16" (8mm) Hole Size 10mm Stem Length 14.50 x 16.00mm Head Size Black Nylon Fender Liner Retainers Toyota # 90467-06192	<b>25 Pcs.</b>		
<b>10414PK</b>	5/16" (8mm) Hole Size 15mm Stem Length 15mm Head Diameter Black Nylon Retaining Clips Mazda # B001-68-302-00 Toyota # 90950-01248	<b>25 Pcs.</b>		
<b>12017PK</b>	5/16" (8mm) Hole Size 15mm Stem Length 18mm Head Diameter Black Nylon Retaining Clips Honda # 74842-659-0030, 74842-659-003 Toyota # 90467-12078, 90467-12078-01	<b>25 Pcs.</b>		

















# Toyota

## Retainers Hood Insulation

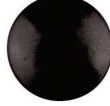

<b>9555PK</b>	15/64" (6mm) Hole Size 16mm Stem Length 30mm Flange Diameter Black Nylon Hood Insulation Retainers Toyota # 90467-08081	<b>15 Pcs.</b>		
<b>12839PK</b>	1/4" (6.50mm) Hole Size 16mm Stem Length 30mm Head Diameter Black Nylon Hood Insulation Retainers Toyota # 90467-09004, 90467-09004-01	<b>15 Pcs.</b>		
<b>13210PK</b>	9/32" (7mm) Hole Size 12mm Stem Length 24mm Head Diameter Black Nylon Hood Insulation Retainers Toyota # 53326-08010	<b>25 Pcs.</b>		
<b>10141PK</b>	9/32" (7mm) Hole Size 12mm Stem Length 25mm Head Diameter Black Nylon Hood Insulation Retainers Toyota # 90467-09050, 90467-A0003	<b>15 Pcs.</b>		
<b>9403PK</b>	9/32" (7mm) Hole Size 12mm Stem Length 25mm Head Diameter Black Nylon Hood Insulation Retainers Toyota # 90467-08124	<b>15 Pcs.</b>		
<b>9328PK</b>	9/32" (7mm) Hole Size 17mm Stem Length 30mm Head Diameter Black Nylon Hood Insulation Retainers Toyota # 90467-09006	<b>15 Pcs.</b>		
<b>1950PK</b>	9/32" (7mm) Hole Size 19mm Stem Length 30mm Head Diameter Black Nylon Hood Insulation Retainers Toyota # 90467-09008, 90467-09008-01	<b>25 Pcs.</b>		

# Toyota

## Retainers Weatherstrip

















<b>9685PK</b>	13/64" (5mm) Hole Size 6mm Stem Length 12mm Head Diameter Black Nylon Weatherstrip Retainers Toyota # 90467-05045-22	<b>25 Pcs.</b>		
<b>11978PK</b>	13/64" (5mm) Hole Size 8mm Stem Length 5.00 x 13.00mm Head Size Black Nylon Hood Seal Retainers Toyota # 65487-60010	<b>25 Pcs.</b>		
<b>12069PK</b>	13/64" (5mm) Hole Size 10mm Stem Length 5.00 x 15.00mm Head Size Natural Nylon Weatherstrip Retainers Ford # E7GZ-6120586-B Hyundai # 86438-2B000 Mazda # G031-58-762 Toyota # 67867-89103, 97868-89101, 67867-28030	<b>50 Pcs.</b>		
<b>9290PK</b>	7/32" (5.50mm) Hole Size 10mm Stem Length 10mm Head Diameter Black Nylon Weatherstrip Retainers Toyota # 67869-20030	<b>25 Pcs.</b>		
<b>13370PK</b>	15/64" (6mm) Hole Size 8.50mm Stem Length 5.00 x 15.00mm Head Size White Nylon Weatherstrip Retainers Honda # 91563-SCV-003 Toyota # 67867-52010, 67867-0D060	<b>25 Pcs.</b>		
<b>14952PK</b>	15/64" (6mm) Hole Size 10mm Stem Length 5.00 x 15.00mm Head Size Black Nylon Weatherstrip Retainers Toyota # 67867-0C010	<b>25 Pcs.</b>		
<b>12503PK</b>	15/64" (6mm) Hole Size 11mm Stem Length 5.00 x 15.00mm Head Size White Nylon Weatherstrip Retainers Toyota # 67867-12150	<b>15 Pcs.</b>		
<b>12917PK</b>	9/32" (7mm) Hole Size 11mm Stem Length 14mm Head Diameter Black Nylon Hood & Weatherstrip Retaining Clips Toyota # 90467-08045, 90467-08063	<b>25 Pcs.</b>		

## Retainers Push Type

<b>15028PK</b>	13/64" (5mm) Hole Size 10mm Stem Length 10mm Head Diameter Black Nylon Front Bumper Push Type Retainer Toyota # 90467-05170	<b>25 Pcs.</b>		
----------------	---	----------------	--	---



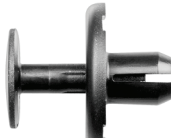









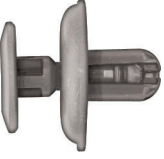

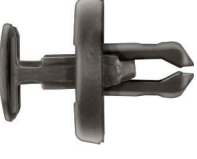

# Toyota

## Retainers Push Type

<b>16148PK</b>	7/32" (5.50mm) Hole Size 15mm Stem Length 13mm Head Diameter Black Nylon Inner Door Lock, Engine Cover & Outside Air Duct Push Type Retainers Toyota # 90467-05156	<b>25 Pcs.</b>		
<b>17598PK</b>	1/4" (6.30mm) Hole Size 13mm Stem Length 15mm Flange Diameter Black Nylon Push Type Retainers G.M. # 96057846 Hyundai # 86155-2200 Toyota # 90467-07041, 90467-07041-B2, 90467-07076-C0	<b>10 Pcs.</b>		
<b>10450PK</b>	9/32" (7mm) Hole Size 7.50mm Stem Length 18mm Flange Diameter Black Nylon Front Fender Liner Push Type Retainers G.M. # 88970767 Toyota # 90467-10183	<b>10 Pcs.</b>		
<b>10537PK</b>	9/32" (7mm) Hole Size 7mm Stem Length 18mm Flange Diameter Black Nylon Fender Liner Push Type Retainers Toyota # 53879-60010	<b>15 Pcs.</b>		
<b>11124PK</b>	9/32" (7mm) Hole Size 8mm Stem Length 19mm Flange Diameter Black Nylon Bumper & Radiator Cover Push Type Retainers Toyota # 90467-07211	<b>10 Pcs.</b>		
<b>12907PK</b>	9/32" (7mm) Hole Size 9mm Stem Length 19mm Head Diameter Black Nylon Push Type Retainers Toyota # 53259-0E010	<b>15 Pcs.</b>		
<b>16142PK</b>	9/32" (7mm) Hole Size 9mm Stem Length 19mm Flange Diameter Black Nylon Access Cover, Air Deflector & Side Sheild Push Type Retainers Toyota # 90467-07217	<b>25 Pcs.</b>		
<b>12451PK</b>	9/32" (7mm) Hole Size 9mm Stem Length 20mm Flange Diameter Black Nylon Radiator Splash Shield Push Type Retainers Toyota # 90467-07214	<b>25 Pcs.</b>		
<b>12002PK</b>	9/32" (7mm) Hole Size 10mm Stem Length 15mm Head Diameter Black Nylon Door Trim Panel Retainers Toyota # 90467-07059-22	<b>15 Pcs.</b>		















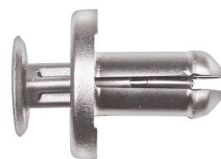

# Toyota

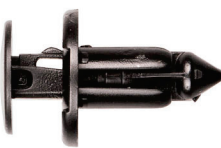
## Retainers Push Type

<b>10569PK</b>	9/32" (7mm) Hole Size 10mm Stem Length 20mm Flange Diameter Black Nylon Engine Under Cover Push Type Retainers Toyota # 90467-07201	<b>10 Pcs.</b>		
<b>10570PK</b>	9/32" (7mm) Hole Size 10mm Stem Length 20mm Flange Diameter Black Nylon Fender Splash Shield Push Type Retainers Suzuki # 09409-07332 Toyota # 90467-07164	<b>10 Pcs.</b>		
<b>9465PK</b>	9/32" (7mm) Hole Size 10mm Stem Length 20mm Flange Diameter Black Nylon Front Fender Liner Push Type Retainers Toyota # 90467-07166	<b>15 Pcs.</b>		
<b>15952PK</b>	9/32" (7mm) Hole Size 10mm Stem Length 20mm Head Diameter Black Nylon Fender Liner Push Type Retainers Toyota # 90467-07215	<b>25 Pcs.</b>		
<b>18239PK</b>	9/32" (7mm) Hole Size 12mm Stem Length 20mm Head Diameter Black Nylon Bumper Cover, Radiator Support, Under Cover Push Type Retainers Toyota # 90467-07220	<b>25 Pcs.</b>		
<b>15310PK</b>	9/32" (7mm) Hole Size 14mm Stem Length 11mm Flange Diameter Black Nylon Bumper Cover Push Type Retainers Toyota # 90467-07071-22	<b>25 Pcs.</b>		
<b>10410PK</b>	9/32" (7mm) Hole Size 14mm Stem Length 11mm Flange Diameter Black Nylon Radiator Grille Push Type Retainers G.M. # 96057847, 94847334 Suzuki # 09409-07313, 90467-07313 Toyota # 90467-07066, 90467-07066-J0	<b>10 Pcs.</b>		
<b>10825PK</b>	9/32" (7mm) Hole Size 14mm Stem Length 15mm Flange Diameter Black Nylon Cowl Vent Retainers Toyota # 90467-07192	<b>15 Pcs.</b>		
<b>18238PK</b>	9/32" (7mm) Hole Size 15mm Stem Length 22mm Head Diameter Black Nylon Cowl Grille Push Type Retainers Toyota # 90767-09242	<b>15 Pcs.</b>		

# Toyota



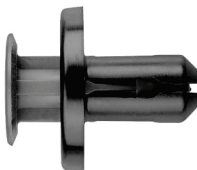





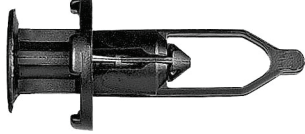

## Retainers Push Type

<b>9114PK</b>	9/32" (7mm) Hole Size 16mm Stem Length 18mm Flange Diameter Black Nylon Push Type Retainers Nissan # 80999-05N07, 01553-00755 Toyota # 90467-07043, 90467-07043-C0, 90467-07043-11	<b>25 Pcs.</b>		
<b>10623PK</b>	9/32" (7mm) Hole Size 17mm Stem Length 15mm Flange Diameter Black Nylon Push Type Retainers Toyota # 90467-07188	<b>15 Pcs.</b>		
<b>10610PK</b>	5/16" (8mm) Hole Size 12mm Stem Length 17mm Flange Diameter Black Nylon Door Trim Panel Retainers Honda # 91505-ST7-003ZA Toyota # 90467-08180	<b>10 Pcs.</b>		
<b>13354PK</b>	5/16" (8mm) Hole Size 16mm Stem Length 20mm Flange Diameter Black Nylon Rocker Panel Push Type Retainers Toyota # 75867-06030	<b>25 Pcs.</b>		
<b>12543PK</b>	5/16" (8mm) Hole Size 19mm Stem Length 18mm Head Diameter Black Nylon Push Type Retainers Toyota # 75867-30120	<b>15 Pcs.</b>		
<b>18234PK</b>	5/16" (8mm) Hole Size 13mm Stem Length 20mm Flange Diameter Black Nylon Bumper, Engine Cover, Fender & Quarter Panel Push Type Retainers Mazda # B45A-56-146A Toyota # 90118-WB048	<b>25 Pcs.</b>		
<b>9285PK</b>	23/64" (9mm) Hole Size 10mm Stem Length 18mm Head Diameter Black Nylon Front Spoiler & Grille Push Type Retainers Toyota # 90467-09185	<b>25 Pcs.</b>		
<b>12452PK</b>	23/64" (9mm) Hole Size 15mm Stem Length 18mm Head Diameter Black Nylon Bumper Cover & Wheel Housing Push Type Retainers Toyota # 90467-09139	<b>15 Pcs.</b>		
<b>12074PK</b>	23/64" (9mm) Hole Size 15mm Stem Length 22mm Flange Diameter Black Nylon Push Type Retainers Toyota # 90467-09227	<b>10 Pcs.</b>		





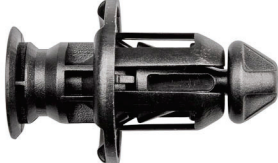

22

# Toyota

## Retainers Push Type















<b>11959PK</b>	23/64" (9mm) Hole Size 27mm Stem Length 15mm Head Diameter Black Nylon Front Fender Push Type Retainers Toyota # 90467-09096	<b>10 Pcs.</b>		
<b>9327PK</b>	23/64" (9mm) Hole Size 28mm Stem Length 18mm Flange Diameter Black Nylon Rear Bumper Cover Push Type Retainers G.M. # 94858560 Toyota # 52161-16010, 52161-02020, 52161-02030	<b>4 Pcs.</b>		
<b>10628PK</b>	23/64" (9mm) Hole Size 31mm Stem Length 18mm Flange Diameter Black Nylon Bumper Cover & Grille Push Type Retainers Toyota # 52161-20010	<b>15 Pcs.</b>		
<b>15144PK</b>	25/64" (10mm) Hole Size 12mm Stem Length 18mm Head Diameter Black Nylon Cowl Vent & Radiator Cover Retainers Toyota # 90467-10170-C0	<b>10 Pcs.</b>		
<b>17075PK</b>	25/64" (10mm) Hole Size 13mm Stem Length 20mm Head Diameter Black Nylon Fender Apron & Interior Trim Push Type Retainers Toyota # 90467-10216	<b>25 Pcs.</b>		
<b>13448PK</b>	33/64" (13mm) Hole Size 14mm Stem Length 22mm Head Diameter Black Nylon Fender Push Type Retainers Toyota # 51453-0E010, 51453-48010	<b>15 Pcs.</b>		

## Retainers Phillips Screw

<b>11145PK</b>	13/64" (5mm) Hole Size 8mm Stem Length 11mm Flange Diameter Black Nylon Front Bumper Phillips Screw Retainers Toyota # 90467-05063-C0	<b>15 Pcs.</b>		
<b>10686PK</b>	13/64" (5mm) Hole Size 12mm Stem Length 10mm Flange Diameter Black Nylon Front Fascia Retainers Toyota # 90467-05090, 90467-05090-B1	<b>25 Pcs.</b>		
<b>10383PK</b>	15/64" (6mm) Hole Size 8mm Stem Length 18mm Head Diameter Black Nylon Back Garnish Trim Panel Phillips Screw Retainers Toyota # 90467-06150	<b>10 Pcs.</b>		

# Toyota



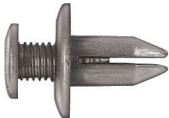







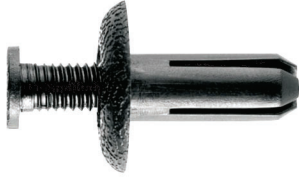

## Retainers Phillips Screw

<b>10615PK</b>	15/64" (6mm) Hole Size 9mm Stem Length 14mm Flange Diameter Black Nylon Phillips Screw Retainers Nissan # 01553-01733 Toyota # 90467-06133-C0	<b>15 Pcs.</b>		
<b>17931PK</b>	17/64" (6.70mm) Hole Size 24mm Stem Length 20mm Head Diameter Red Nylon W/Phillips Drive Body Side Retainers Toyota # 90467-09237	<b>25 Pcs.</b>		
<b>13358PK</b>	9/32" (7mm) Hole Size 8mm Stem Length 20mm Flange Diameter Black Nylon Door Trim Panel Retainers Toyota # 90467-07121	<b>10 Pcs.</b>		
<b>12903PK</b>	9/32" (7mm) Hole Size 9mm Stem Length 16mm Flange Diameter Black Nylon Cowl Panel Phillips Screw Retainers Toyota # 90467-07146	<b>15 Pcs.</b>		
<b>10716PK</b>	9/32" (7mm) Hole Size 9mm Stem Length 20mm Flange Diameter Black Nylon Garnish Moulding Phillips Screw Retainers G.M. # 88970494, 88973676 Toyota # 90467-07168, 90467-07168-C1	<b>15 Pcs.</b>		
<b>10413PK</b>	9/32" (7mm) Hole Size 9mm Stem Length 20mm Flange Diameter Black Nylon Quarter Panel Moulding Phillips Screw Retainers G.M. # 96064506 Suzuki # 09409-07303-5ES Toyota # 90467-07044	<b>10 Pcs.</b>		
<b>2015PK</b>	9/32" (7mm) Hole Size 11mm Stem Length 14mm Flange Diameter Black Nylon Phillips Screw Retainers G.M. # 94198687 Honda # 90657-SA6-0030, 90657-SA6-003 Mazda # N304-13-356-A, N304-13-356B Subaru # 59130AA000 Toyota # 90467-07072, 90467-07072-22	<b>25 Pcs.</b>		
<b>1603PK</b>	9/32" (7mm) Hole Size 12mm Stem Length 15mm Flange Diameter Black Nylon Phillips Screw Retainers G.M. # 20426301 Mazda # 9926-50-625 Toyota # 90467-06017, 90467-06017-41, 90467-06017-C0	<b>15 Pcs.</b>		

22

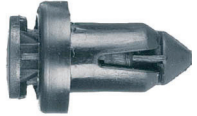
# Toyota

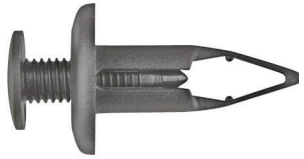

## Retainers Phillips Screw

<b>12285PK</b>	9/32" (7mm) Hole Size 14mm Stem Length 14mm Flange Diameter Black Nylon Interior Trim Phillips Screw Retainers Toyota # 90467-07190-B2	<b>10 Pcs.</b>		
<b>12042PK</b>	9/32" (7mm) Hole Size 14mm Stem Length 16mm Flange Diameter Black Nylon Turn Signal Phillips Screw Retainers Toyota # 90080-46294	<b>10 Pcs.</b>		
<b>2163PK</b>	5/16" (8mm) Hole Size 21mm Stem Length 20mm Flange Diameter Black Nylon Phillips Screw Retainers Acura # 90505-SL0-003 Chrysler # MB888869 G.M. # 9485236 Toyota # 90467-08155	<b>5 Pcs.</b>		
<b>10624PK</b>	23/64" (9mm) Square Hole Size 9mm Stem Length 20mm Flange Diameter Black Nylon Phillips Screw Retainers Toyota # 90467-09166	<b>15 Pcs.</b>		
<b>2027PK</b>	23/64" (9mm) Hole Size 16mm Stem Length 15mm Flange Diameter Black Nylon Bumper Cover Phillips Screw Retainers Toyota # 90467-09145	<b>15 Pcs.</b>		
<b>9646PK</b>	23/64" (9mm) Hole Size 26mm Stem Length 20mm Flange Diameter Black Nylon Bumper Cover Phillips Screw Retainers Toyota # 90467-09127	<b>10 Pcs.</b>		
<b>18759PK</b>	(12.50mm) Hole Size 30mm Stem Length 22mm Flange Diameter Black Nylon Phillips Screw Retainers Toyota # 52599-08010	<b>10 Pcs.</b>		

## Clips Door Handle

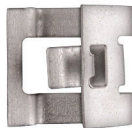

<b>812PK</b>	Door Window Crank Handle Bright Zinc Finish Retaining Clips Toyota # 90520-01002, 90520-01274	<b>100 Pcs.</b>		
--------------	---	-----------------	---	--

## Clips Retaining







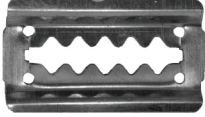

<b>15309PK</b>	16mm Width 17mm Height Dacromet Finish Front & Rear Spoiler Locking Retainers Toyota # 76879-44010	<b>15 Pcs.</b>		
----------------	---	----------------	--	---

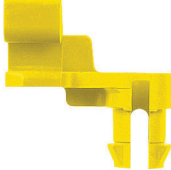
# Toyota

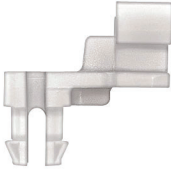
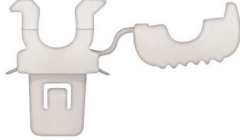



## Retainers Bumper

<b>1585PK</b>	1" Length 5/8" Width 1/2" Overall Height Black Nylon Front Bumper Cushion Retaining Clips Toyota # 90183-03001, 90468-04038	<b>25 Pcs.</b>		
<b>1584PK</b>	27mm Length 16mm Width Bright Zinc Finish Bumper Strip Retainers Mitsubishi # MB325299 Toyota # 90468-04030	<b>25 Pcs.</b>		

## Clips Door Rod End

<b>10109PK</b>	5mm Rod Size 7mm Hole Size Left Hand Side Yellow Nylon Door Rod End Clips Toyota # 69293-33020, 69293-12040	<b>10 Pcs.</b>		
<b>10110PK</b>	5mm Rod Size 7mm Hole Size Right Hand Side Natural Nylon Door Rod End Clips Toyota # 69293-33010, 69293-12030	<b>10 Pcs.</b>		
<b>10120PK</b>	5mm Rod Size 8mm Hole Size Universal Natural Nylon Door Rod Clips Toyota # 69293-30030	<b>10 Pcs.</b>		
<b>10117PK</b>	5mm Rod Size 8.50mm Hole Size Left Hand Side Yellow Nylon Door Rod End Clips Toyota # 69293-12060	<b>10 Pcs.</b>		
<b>10116PK</b>	5mm Rod Size 8.50mm Hole Size Right Hand Side Natural Nylon Door Rod End Clips Toyota # 69293-12050	<b>10 Pcs.</b>		











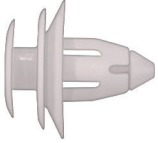



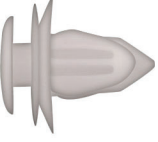

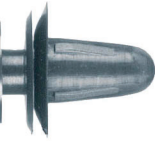
## Retainers Door Trim Panel

<b>9686PK</b>	5/16" (8mm) Hole Size 10mm Stem Length 18mm Flange Diameter Red Nylon Scuff Plate Retainers Toyota # 90467-11111	<b>10 Pcs.</b>		
<b>18804PK</b>	5/16" (8mm) Hole Size 11mm Stem Length 13mm Top Head Diameter Black & White Lifgate & Quarter Trim Panel Retainers Toyota # 63395-12150	<b>25 Pcs.</b>		

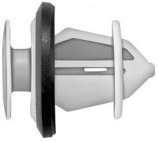
22

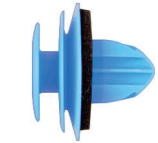
# Toyota













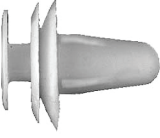

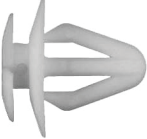

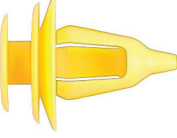
## Retainers Door Trim Panel

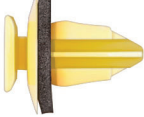
<b>17876PK</b>	5/16" (8mm) Hole Size 13mm Stem Length 13mm Top Head Diameter White Nylon Door Trim Panel Retainers Toyota # 67771-06010, 67771-32090	<b>10 Pcs.</b>		
<b>18781PK</b>	5/16" (8mm) Hole Size 13mm Stem Length 13mm Top Head Diameter Blue Nylon Rocker Panel Retainers Toyota # 75867-52020	<b>25 Pcs.</b>		
<b>12828PK</b>	21/64" (8.50mm) Hole Size 14mm Stem Length 13mm Top Head Diameter White Nylon Door Trim Panel Retainers G.M. # 94858299, 94178705 Toyota # 90467-10161, 90467-A0006	<b>25 Pcs.</b>		
<b>1588PK</b>	21/64" (8.50mm) Hole Size 14mm Stem Length 13mm Top Head Diameter Black Nylon Door Trim Panel Retainers G.M. # 95005064 Toyota # 67771-01010	<b>25 Pcs.</b>		
<b>10687PK</b>	21/64" (8.50mm) Hole Size 14mm Stem Length 13mm Top Head Diameter Turquoise Nylon Door Trim Panel Retainers Toyota # 90467-10188	<b>25 Pcs.</b>		
<b>10202PK</b>	21/64" (8.50mm) Hole Size 16.50mm Stem Length 13mm Top Head Diameter White Nylon With Sealer Door Panel Retainers Toyota # 67773-0E020	<b>25 Pcs.</b>		
<b>11977PK</b>	23/64" (9mm) Hole Size 10mm Stem Length 13mm Top Head Diameter Blue Nylon With Sealer Door Trim Retainers Toyota # 67771-26240	<b>25 Pcs.</b>		
<b>2145PK</b>	23/64" (9mm) Hole Size 11mm Stem Length 13mm Top Head Diameter Natural Nylon Door Trim & Garnish Retainers Toyota # 67771-30070	<b>25 Pcs.</b>		
<b>16405PK</b>	23/64" (9mm) Hole Size 11mm Stem Length 13mm Top Head Size White Nylon Scuff Plate Retainers Toyota # 90467-A0007	<b>25 Pcs.</b>		

22

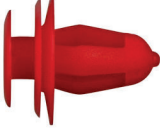

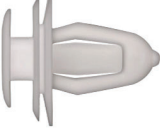





# Toyota

## Retainers Door Trim Panel



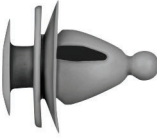



<b>10748PK</b>	23/64" (9mm) Hole Size 13mm Stem Length 13mm Top Head Diameter White Nylon Door Panel & Rocker Moulding Retainers G.M. # 88970656 Toyota # 67771-12080	<b>15 Pcs.</b>		
<b>9081PK</b>	23/64" (9mm) Hole Size 14mm Stem Length 13mm Top Head Diameter Natural Nylon Door Trim Panel Retainers G.M. # 94226492 Isuzu # 8-94226-492-0, Mazda # 9927-40-825, Toyota # 67771-01010, 67771-12010F	<b>25 Pcs.</b>		
<b>10405PK</b>	23/64" (9mm) Hole Size 14mm Stem Length 14mm Head Diameter White Nylon Door Trim Panel Retainers Mazda # 9927-40-822 Toyota # 62581-14020	<b>25 Pcs.</b>		
<b>11366PK</b>	23/64" (9mm) Hole Size 15mm Stem Length 13mm Top Head Diameter Yellow Nylon Door Trim Panel Retainers G.M. # 95008221 Mitsubishi # MB608104 Toyota # 67771-30090	<b>15 Pcs.</b>		
<b>11976PK</b>	23/64" (9mm) Hole Size 15mm Stem Length 10mm Top Head Size Yellow Nylon With Sealer Door Garnish Retainers Toyota # 76817-68010	<b>25 Pcs.</b>		
<b>10724PK</b>	23/64" (9mm) Hole Size 15mm Stem Length 13mm Top Head Diameter White Nylon With Sealer Door Trim Panel Retainers Toyota # 90467-A0005	<b>15 Pcs.</b>		
<b>12559PK</b>	23/64" (9mm) Hole Size 15mm Stem Length 13mm Top Head Diameter Maroon Nylon Trim Panel Retainers G.M. # 30006620 Toyota # 67771-12050	<b>15 Pcs.</b>		
<b>12726PK</b>	3/8" (9.50mm) Hole Size 13mm Stem Length 13mm Top Head Diameter White Nylon Door Trim Panel Retainers Toyota # 67771-02030, 67771-12030	<b>50 Pcs.</b>		
<b>13250PK</b>	3/8" (9.50mm) Hole Size 14mm Stem Length 15.50mm Head Diameter Blue & Natural Nylon Door Trim Panel Retainers Toyota # 67771-22010	<b>25 Pcs.</b>		

# Toyota

## Retainers Door Trim Panel

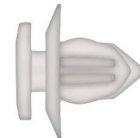

<b>18218PK</b>	3/8" (9.50mm) Hole Size 15mm Stem Length 13mm Top Head Diameter White Nylon With Sealer Door Trim Panel Retainers Toyota # 90467-09206	<b>15 Pcs.</b>		
<b>9263PK</b>	25/64" (10mm) Hole Size 11mm Stem Length 13mm Top Head Diameter White Nylon Quarter Board & Inside Door Trim Panel Retainers Toyota # 67771-89104	<b>15 Pcs.</b>		
<b>12854PK</b>	25/64" (10mm) Hole Size 14mm Stem Length 13mm Top Head Diameter Gray Nylon Door Trim Panel Retainers Toyota # 67771-03030	<b>50 Pcs.</b>		
<b>13249PK</b>	7/16" (11mm) Hole Size 14mm Stem Length 13mm Head Diameter White Nylon Door Trim Panel Retainers Toyota # 67771-12070	<b>15 Pcs.</b>		
<b>18163PK</b>	3/8" (9.50mm) Hole Size 14mm Top Rubber Diameter 16.50mm Overall Length Rubber & Nylon Rear Door Bumper Retainers Toyota # 90541-09124	<b>25 Pcs.</b>		

## Clips Retaining



<b>10750PK</b>	23/64" (9mm) Hole Size 10mm Stem Length 10.00 x 13.00mm Top Head Diameter Yellow Nylon Fender Flare Retainers G.M. # 88969790 Toyota # 75867-21010	<b>25 Pcs.</b>		
<b>12484PK</b>	21/64" (8.50mm) Hole Size 12mm Stem Length 13mm Top Head Diameter White Nylon Scuff Plate Retainers Toyota # 90467-10162	<b>15 Pcs.</b>		
<b>10635PK</b>	23/64" (9mm) Hole Size 14mm Stem Length 13mm Top Head Diameter Black Nylon Rocker Panel & Scuff Plate Retainers Toyota # 78867-AA010	<b>15 Pcs.</b>		
<b>9092PK</b>	5/16" (8mm) Hole Size 13mm Stem Length 16.50mm Head Diameter Black Nylon Dash & Fender Apron Seal Retainers Toyota # 90467-10186	<b>25 Pcs.</b>		

# Toyota

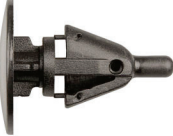

## Clips Retaining

<b>15150PK</b>	23/64" (9mm) Hole Size 10mm Stem Length 13mm Top Head Size Yellow Nylon With Sealer Rear Light Housing Guide Clips Toyota # 81496-21010	<b>10 Pcs.</b>		
<b>12901PK</b>	23/64" (9mm) Hole Size 22mm Stem Length 18mm Head Diameter Black Nylon Rocker Panel Clips Toyota # 75867-30110	<b>15 Pcs.</b>		









## Retainers Door Trim Panel

<b>18810PK</b>	13.50 x 17.00mm Hole Size 13mm Stem Length 19.00 x 23.00mm Head Size White Nylon With Sealer Side Panel Retainers Toyota # 76828-60030	<b>25 Pcs.</b>		
----------------	---	----------------	--	---

## Retainers Tail Light

<b>11871PK</b>	8.50 x 10.50mm Hole Size 10.70mm Stem Length 13mm Top Head Diameter White Nylon With Sealer Tail Lamp Assembly Retainers Toyota # 81496-60010	<b>25 Pcs.</b>		
----------------	--	----------------	--	--

## Retainers Grille

<b>10421PK</b>	5/16" (8mm) Hole Size 10mm Stem Length 15mm Head Diameter Natural Nylon With Sealer Radiator Grille Retainers G.M. # 94848834 Toyota # 62955-20020, 62955-12010	<b>25 Pcs.</b>		
<b>10430PK</b>	8.00 x 9.00mm Hole Size 10mm Stem Length Black Nylon Radiator Grille Retainers Toyota # 90904-67021	<b>15 Pcs.</b>		
<b>9082PK</b>	22mm Overall Length 13mm Width Black Plastic Headlight Grille Clips G.M. # 94218027, H200-50-715 Isuzu # 8942180270, 58974-00008 Mazda # B092-50-715, BF67-S0715 Mitsubishi # MB153825 Toyota # 90467-13011, 90467-12020	<b>25 Pcs.</b>		
<b>1436PK</b>	23mm Overall Length 13mm Wide Black Nylon Grille Clips Toyota # 90467-13005, 90467-13008	<b>25 Pcs.</b>		

# Toyota

## Retainers Grille

**1932PK** 23mm Overall Length  
23mm Width  
Black Nylon  
Radiator Grille Clips  
Toyota # 90467-17004

10 Pcs.



## Retainers Cowl Panel

**15947PK** 9/32" (7mm) Hole Size  
14mm Stem Length  
8.00 x 17.00mm Head Size  
Black Nylon  
Cowl Panel Retainers  
Toyota # 90467-10146

25 Pcs.



**11964PK** 11/32" (8.50mm) Hole Size  
10.70mm Stem Length  
13.00 x 18.00mm Head Size  
White Nylon With Sealer  
Cowl Trim Retainers  
Toyota # 90467-09212

25 Pcs.



**12375PK** 23/64" (9mm) Pin Size  
17mm Stem Length  
16mm Head Diameter  
Black Nylon  
Cowl Vent Pin Retainers  
Use With # 12376  
Toyota # 90467-07126

10 Pcs.

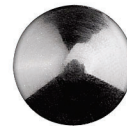

**12376PK** 23/64" (9mm) Hole Size  
16mm Stem Length  
18mm Head Diameter  
White Nylon  
Cowl Vent Grommets  
Use With # 12375  
Toyota # 90467-10152

10 Pcs.



## Retainers Slotted Screw

**17611PK** 32mm Width  
39mm Length  
Black Nylon  
Front Bumper  
Cover Retainers  
Use With Disco # 11950  
Toyota # 53879-30040

5 Pcs.

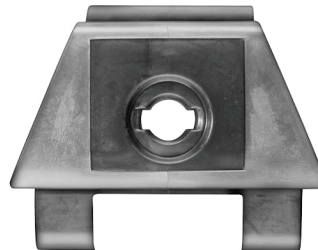









**15954PK** 42mm Width  
29.50mm Length  
Black Nylon  
Fender Liner Retainers  
Use With # 11950  
Toyota # 53879-30050

15 Pcs.











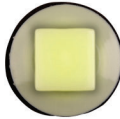

# Toyota

## Retainers Slotted Screw

<b>11951PK</b>	35mm Width 25mm Length Black Nylon Cover & Fender Liner Retainers Use With Disco # 11950 Lexus # 53879-50020	<b>10 Pcs.</b>		
<b>11950PK</b>	10mm Head Diameter 24mm Stem Length Black Nylon Front Bumper Cover & Fender Liner Pins Use With # 11951 & 17611 Lexus # 47749-50090 Toyota # 53879-30040	<b>15 Pcs.</b>		
<b>10608PK</b>	25mm Width 34mm Length Black Nylon Front Fender & Bumper Cover Clips Use With # 10609 G.M. # 19183888 Toyota # 53879-58010, 53879-02070	<b>5 Pcs.</b>		
<b>10609PK</b>	15mm Head Diameter 25mm Stem Length Black Nylon Front Fender & Bumper Cover Pins Use With # 10608 G.M. # 19183917 Toyota # 47749-58010	<b>10 Pcs.</b>		

## Retainers Moulding



















<b>11974PK</b>	9/32" (7mm) Hole Size 11mm Stem Length 8mm Top Head Diameter Yellow Nylon With Sealer Rocker Moulding Retainers Toyota # 62955-50010	<b>25 Pcs.</b>		
<b>15513PK</b>	5/16" (8mm) Hole Size 8mm Stem Diameter 15mm Flange Diameter White Nylon Wheel Opening Moulding Retainers Toyota # 90467-08225	<b>25 Pcs.</b>		
<b>12521PK</b>	5/16" (8mm) Hole Size 9mm Stem Length 8.00 x 8.00mm Head Size 15mm Flange Size Butterscotch Nylon With Sealer Door Moulding Retainers Toyota # 90467-10077, 90080-46269	<b>15 Pcs.</b>		
<b>15946PK</b>	5/16" (8mm) Hole Size 10mm Stem Length 10mm Top Head Diameter White Nylon With Sealer Lower Door Moulding Retainers Toyota # 90467-A0032	<b>25 Pcs.</b>		
<b>11123PK</b>	5/16" (8mm) Hole Size 10mm Stem Length 13mm Top Head Diameter Black Nylon Rocker Moulding Retainers Toyota # 75867-02010	<b>25 Pcs.</b>		

22

NEW!

# Toyota

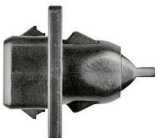









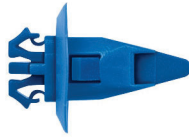

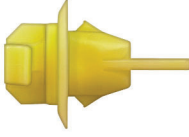

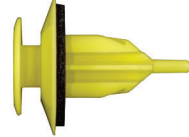



## Retainers Moulding

<b>12921PK</b>	5/16" (8mm) Hole Size 11mm Stem Length 13mm Head Diameter Blue Nylon Garnish Moulding Retainers G.M. # 88970345 Toyota # 90467-10167	<b>25 Pcs.</b>		
<b>13441PK</b>	5/16" (8mm) Hole Size 13mm Stem Length 13mm Top Head Diameter White Nylon With Sealer Rocker Moulding Retainers Toyota # 75867-30130	<b>25 Pcs.</b>		
<b>18782PK</b>	5/16" (8mm) Hole Size 13mm Top Head Diameter 14.50mm Stem Length White Nylon Rocker Panel & Wheel Opening Moulding Retainers Toyota # 75867-68010	<b>50 Pcs.</b>		
<b>9076PK</b>	5/16" (8mm) Hole Size 13mm Stem Length 18mm Flange Diameter Black & White Nylon Garnish Retainers Toyota # 90467-10168	<b>5 Pcs.</b>		
<b>10751PK</b>	21/64" (8.50mm) Hole Size 11mm Stem length 13mm Top Head Diameter White Nylon Garnish Moulding Retainers Toyota # 62217-13010	<b>25 Pcs.</b>		
<b>10839PK</b>	21/64" (8.50mm) Hole Size 13mm Stem Length 18mm Head Diameter White Nylon With Sealer Moulding Retainers Toyota # 75395-0T010	<b>25 Pcs.</b>		
<b>10392PK</b>	23/64" (9mm) Hole Size 9mm Stem Length 18mm Head Diameter White Nylon With Sealer Rocker Panel Moulding Retainers Suzuki # 77553-65D00 Toyota # 90467-11063	<b>15 Pcs.</b>		
<b>9946PK</b>	23/64" (9mm) Hole Size 13mm Stem Length 17mm Head Diameter Red Nylon Fender Moulding Retainers Toyota # 90904-67037	<b>10 Pcs.</b>		
<b>11144PK</b>	23/64" (9mm) Hole Size 13mm Stem Length 18.00 x 18.00mm Head Size Black Nylon Front Fender Upper Seal Moulding Retainers Toyota # 61118-35010	<b>15 Pcs.</b>		
<b>10492PK</b>	23/64" (9mm) Hole Size 17mm Stem Length 17mm Head Diameter Orange Nylon With Sealer Wheel Flare Moulding Retainers Toyota # 75397-35010	<b>10 Pcs.</b>		

22













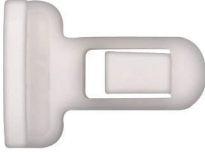



# Toyota

## Retainers Moulding

<b>10113PK</b>	23/64" (9mm) Hole Size 17mm Stem Length 17mm Head Diameter Blue Nylon Fender & Wheel Flare Moulding Retainers Toyota # 90904-67036	<b>10 Pcs.</b>		
<b>10112PK</b>	23/64" (9mm) Hole Size 17mm Stem Length 17mm Head Diameter Yellow Nylon Fender & Wheel Flare Moulding Retainers Toyota # 90467-11100	<b>10 Pcs.</b>		
<b>16353PK</b>	23/64" (9mm) Hole Size 19mm Stem Length 13mm Top Head Size Yellow Nylon With Sealer Rocker Moulding Retainers Toyota # 75868-60020	<b>25 Pcs.</b>		
<b>18805PK</b>	25/64" (9.50mm) Hole Size 11mm Stem Length 13mm Top Head Diameter White Nylon With Sealer Stop Lamp Housing Retainers Toyota # 81496-28010	<b>25 Pcs.</b>		 <b>NEW!</b>
<b>10490PK</b>	25/64" (10mm) Hole Size 11mm Stem Length 17mm Head Diameter Blue Nylon With Sealer Rocker Moulding Retainers Toyota # 75396-35020, 75495-35010	<b>10 Pcs.</b>		
<b>17944PK</b>	25/64" (10mm) Hole Size 19mm Stem Length 10.30 x 16.50mm Top Head Size Yellow Nylon With Sealer Rocker Moulding Retainers Toyota # 75494-42010, 75395-42020	<b>25 Pcs.</b>		
<b>10394PK</b>	9.00 x 12.00mm Hole Size 20mm Stem Length 20mm Head Diameter White Nylon Garnish Moulding Retainers Toyota # 75498-42010	<b>10 Pcs.</b>		
<b>12012PK</b>	10.00 x 16.00mm Hole Size 12mm Stem Length 14mm Top Head Diameter Dark & Light Gray Nylon With Sealer Front Fender Retainers Toyota # 53867-47020	<b>10 Pcs.</b>		
<b>15497PK</b>	1/2" (12.40mm) Overall Height White Nylon Door & Garnish Moulding Retainers Toyota # 67771-58010	<b>25 Pcs.</b>		
<b>15515PK</b>	14mm Height White Nylon Rear Door, Side Garnish & Front Body Moulding Retainers Toyota # 90467-09204	<b>25 Pcs.</b>		

# Toyota

## Retainers Moulding

<b>9340PK</b>	21mm Overall Height 7.50mm Width Pink Nylon Door Trim, Instrument Panel, Rear Deck & Roof Garnish Trim Moulding Retainers Toyota # 90467-12080	<b>25 Pcs.</b>		
<b>13443PK</b>	24mm Stem Length 27mm Overall Length 10.00 x 20.00mm Head Size White Nylon Front & Rear Spoiler Moulding Retainers Toyota # 75392-35220	<b>25 Pcs.</b>		
<b>12517PK</b>	13.00 x 26.00mm Head Size 24mm Stem Length Blue Nylon Fender Flare & Bumper Retaining Clips Toyota # 75392-35200, 75392-04010	<b>15 Pcs.</b>		
<b>9338PK</b>	13.00 x 26.00mm Head Size 25mm Stem Length White Nylon Front & Rear Bumper Retaining Clips Toyota # 76853-10010	<b>25 Pcs.</b>		
<b>10806PK</b>	13/64" (5mm) Hole Size 8mm Stem Length 47mm Overall Length Gray Nylon Front Bumper Moulding Retainers Toyota # 52115-48040	<b>10 Pcs.</b>		
<b>17909PK</b>	9/32" (7mm) Hole Size 10mm Stem Length 20.00 x 30.00mm Head Size Black Nylon With Sealer Front Fender Moulding Retainers Toyota # 53857-12010	<b>15 Pcs.</b>		
<b>10989PK</b>	23/64" (9mm) Square Hole 12mm Stem Length 21.00 x 30.00mm Head Size White Nylon Bumper Cover Clips Toyota # 90084-46020	<b>10 Pcs.</b>		
<b>11973PK</b>	9/16" (14mm) Hole Size 11mm Stem Length 25mm Head Diameter Black Nylon Rocker Moulding Retainers Toyota # 76924-13020	<b>25 Pcs.</b>		

# Toyota

## Retainers Moulding

<b>18231PK</b>	17.00 x 22.00mm Hole Size 10mm Stem Length 28.00 x 37.00mm Head Size Black Nylon Rocker & Quarter Moulding Retainers Toyota # 76924-12030	<b>25 Pcs.</b>		
<b>15155PK</b>	7/8" (22mm) Hole Size 10mm Stem Length 32mm Head Diameter Black Nylon Rocker Moulding Retainers G.M. # 88970495, 88973654 Toyota # 76924-52021, 76924-02010, 76924-02020	<b>25 Pcs.</b>		
<b>11419PK</b>	7/8" (22mm) Hole Size 10mm Stem Length 43.00 x 54.00mm Head Size Black Nylon Rocker Panel Moulding Retainers Toyota # 76924-47010	<b>5 Pcs.</b>		
<b>18252PK</b>	7/8" (22mm) Hole Size 11mm Stem Length 38mm Head Diameter Black Nylon With Sealer Rocker Moulding Retainers Toyota # 90467-22014	<b>10 Pcs.</b>		
<b>15149PK</b>	7/8" (22mm) Hole Size 12mm Stem Length 32mm Head Diameter Black Nylon Moulding Retainers Toyota # 76924-47020	<b>15 Pcs.</b>		

# Toyota

## Retainers Moulding

**18253PK** 7/8" (22mm) Hole Size  
35mm Stem Length  
47mm Head Diameter  
Black Nylon With Sealer  
Rocker Panel Moulding Retainers  
Toyota #90467-22015

10 Pcs.

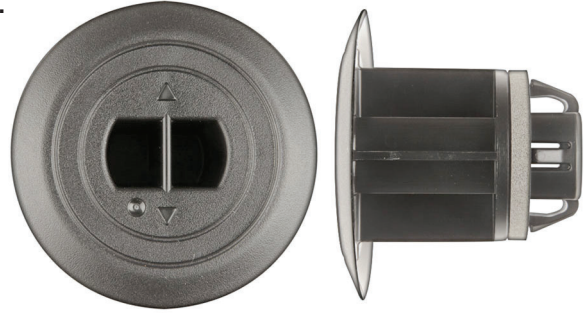

Not Actual Size

**10971PK** 17mm Overall Height  
30mm Overall Length  
Black Nylon  
Bumper Filler Clips  
Toyota # 53935-35020

10 Pcs.



**10807PK** 23/64" (9mm) Square Hole Size  
13mm Stem Length  
30mm Head Diameter  
Black Nylon With Sealer  
Front Bumper Moulding Retainers  
Toyota # 52197-52010

10 Pcs.



**11249PK** 9.00 x 31.00mm Head Size  
30mm Overall Height  
Black Nylon  
Front Fender Sheet Metal  
Upper Seal Moulding Retainers  
Toyota # 61991-35010

10 Pcs.

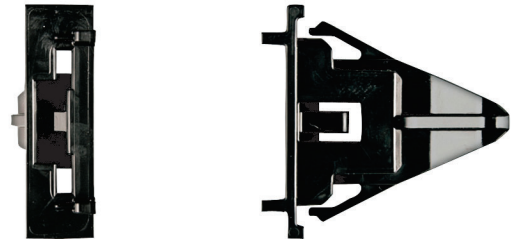

**11248PK** 13.00 x 31.00mm Head Size  
34mm Overall Height  
Black Nylon  
Front Fender Sheet Metal  
Upper Seal Moulding Retainers  
Toyota # 61992-35010

10 Pcs.

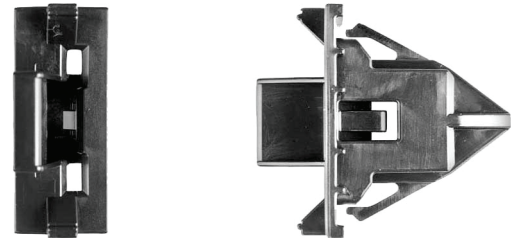

22

# Toyota

## Retainers Moulding

**11418PK** 15/64" (6mm) Square Hole Size  
15mm Stem Length  
25.00 x 74.00mm Head Diameter  
Black Nylon  
Front Bumper Moulding Retainers  
Toyota # 52115-0C090



**16390PK** 1/2" (12.70mm) Hole Size  
23mm Stem Length  
17.00 x 37.00mm Head Size  
Black Nylon  
Bumper to Fender Retainers  
Use With Disco # 16098  
Toyota # 47749-33030, 47749-02020



**16098PK** 43mm Overall Length  
39mm Overall Width  
Black Nylon  
Bumper to Fender Liner Clips  
Use With Disco # 16390  
Toyota # 53879-02150, 53879-33030



## Clips Window Regulators

**13684PK** Natural Nylon  
Window Regulator Dowels  
Ford Explorer 2002-2005

