

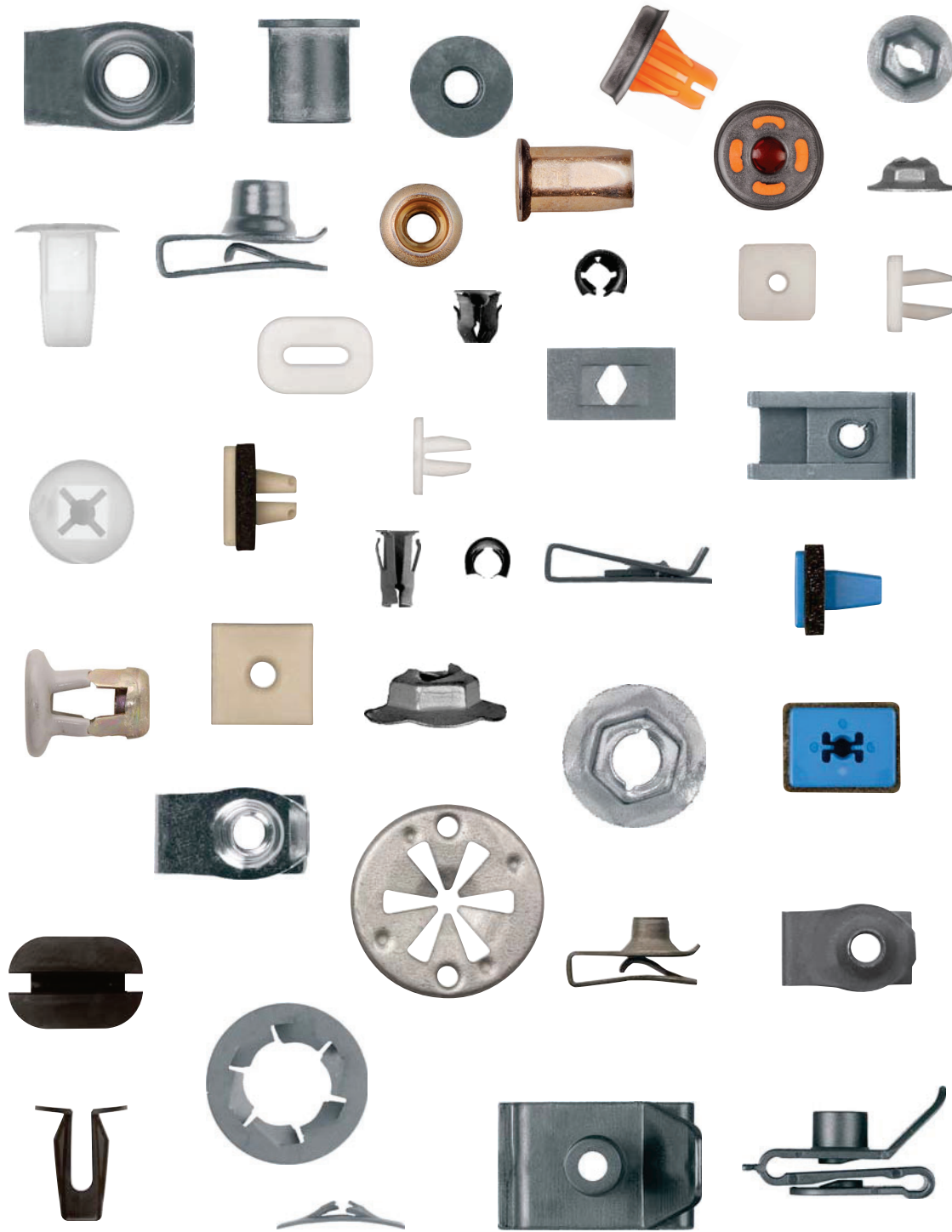











Specialty Nuts







Specialty Nuts





Nuts Barrel

708PK	1/8" Stud Size 5/32" Hole Size Black Finish Barrel Nuts	100 Pcs.		
709PK	1/8" Stud Size 3/16" Hole Size Black Finish Barrel Nuts Ford # 375890-S100	100 Pcs.		
710PK	1/8" Stud Size 1/4" Hole Size Black Finish Barrel Nuts Ford # 375480-S100, 3783794	100 Pcs.		
711PK	3/16" Stud Size 7/32" Hole Size Black Finish Barrel Nuts Chrysler # 6000558	100 Pcs.		
9878PK	3/16" Stud Size 17/64" Hole Size Black Nylon Barrel Nuts Ford # D7VY-6050074-A Renault # 8934-201-767	100 Pcs.		
9941PK	1/4" Stud Size 9/32" Hole Size Black Finish Barrel Nuts Ford # 354341-S	100 Pcs.		

Nuts Flat Type Speed

690PK	3/16" Stud Size 3/8 x 5/8" Plate Size Black Finish Flat Type Speed Nuts	100 Pcs.		
9894PK	#10-24 Stud Size 7/16 x 3/4" Plate Size Black Phosphate Finish Flat Type Speed Nuts	100 Pcs.		



Nuts Push On Type Non-Threaded Stud

1684PK	1/8" Stud Size 3/8" Outside Diameter Flange Zinc Finish Push On Type Retainers	100 Pcs.	
1685PK	5/32" Stud Size 7/16" Outside Diameter Flange Zinc Finish Push On Type Retainers	100 Pcs.	
1686PK	3/16" Stud Size 7/16" Outside Diameter Flange Zinc Finish Push On Type Retainers Chrysler # 6031147	100 Pcs.	
1687PK	1/4" Stud Size 17/32" Outside Diameter Flange Zinc Finish Push On Type Retainers	100 Pcs.	
12655PK	3/8" Screw Size 3/4" Outside Diameter Flange Zinc Finish Push On Retainers	100 Pcs.	

5

Specialty Nuts







Nuts Push On Type Non-Threaded Stud Metric

9850PK	3.20mm Stud Size 9.50mm Outside Diameter Flange Zinc Finish Push On Type Retainers G.M. # 11502794	100 Pcs.	
1691PK	4mm Stud Size 11mm Outside Diameter Flange Black Finish Push On Type Retainers	100 Pcs.	

Nuts Specialty

16383PK	3.50mm Stud Size 12mm Outside Diameter Stainless Steel Emblem Push Nuts Mazda # 9957-83-000	50 Pcs.	
----------------	---	----------------	---









Nuts Push On Type Threaded Stud

9852PK	#8 (5/32") Screw Size 3/8" Outside Diameter Flange Black Finish Push On Type Retainers	100 Pcs.	
12912PK	#10 (3/16") Screw Size 7/16" Outside Diameter Flange Black Finish Push On Type Retainers Chrysler # 6029348	100 Pcs.	
1273PK	1/4" Screw Size 1/2" Outside Diameter Flange Black Finish Push On Type Retainers Chrysler # 6026958	100 Pcs.	
1274PK	5/16" Screw Size 5/8" Outside Diameter Flange Zinc Finish Push On Type Retainers Chrysler # J4004354, J4005293	100 Pcs.	
989PK	3/8" Screw Size 25/32" Outside Diameter Flange Black Finish Push On Type Retainers Chrysler # J4004354	100 Pcs.	
990PK	7/16" Screw Size 27/32" Outside Diameter Flange Black Finish Push On Type Retainers Chrysler # J4004175	100 Pcs.	
991PK	1/2" Screw Size 15/16" Outside Diameter Flange Black Finish Push On Type Retainers Chrysler # 6026430	100 Pcs.	

5

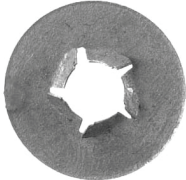
Specialty Nuts

Nuts Push On Type Threaded Stud Metric

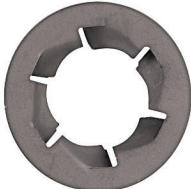
12023PK	5-.80mm Screw Size 11mm Outside Diameter Flange Zinc Finish Push On Type Retainers Chrysler # 6100839	100 Pcs.	
1275PK	6-1.00mm Screw Size 12.70mm Outside Diameter Flange Zinc Finish Push On Type Retainers	100 Pcs.	
1621PK	6-1.00mm Screw Size 17mm Outside Diameter Flange Zinc Plated Push On Type Retainers Chrysler # 6501178, 6501192 Ford # N801192S36 G.M. # 11503736, 11609738, 14093869	100 Pcs.	
1043PK	8-1.25mm Screw Size 16mm Outside Diameter Flange Zinc Finish Push On Type Retainers Chrysler # 6501025 G.M. # 11502504, 11502853	100 Pcs.	
3010PK	8-1.25mm Screw Size 24mm Outside Diameter Flange Zinc Finish Bumper Strip Retainers Chrysler # 6501825 G.M. # 10009923	50 Pcs.	
9335PK	10-1.50mm Screw Size 20mm Outside Diameter Flange Black Finish Push On Type Retainers G.M. # 11502759	50 Pcs.	
1276PK	10-1.50mm Screw Size 24mm Outside Diameter Flange Dacromet Finish Push On Type Retainers G.M. # 11501849	50 Pcs.	
1044PK	12-1.75mm Screw Size 21.40mm Outside Diameter Flange Black Finish Push On Type Retainers G.M. # 11502737	50 Pcs.	
9952PK	14-2.00mm Screw Size 25mm Outside Diameter Flange Black Finish Push On Type Retainers G.M. # 11504119	50 Pcs.	

5

Specialty Nuts

Nuts Push On Type Threaded Stud Metric

17093PK 16mm Screw Size
35mm Outside Diameter Flange
Zinc Finish
Push On Type Retainers
Ford # W721197-S437M

25 Pcs.



Nuts Thread Cutting

265PK 1/8" Stud Size
5/16" Hex Size
17/32" Flange Diameter
Zinc Finish
Thread Cutting Nuts

100 Pcs.



264PK 5/32" Stud Size
3/8" Hex Size
9/16" Flange Diameter
Zinc Finish
Thread Cutting Nuts

100 Pcs.

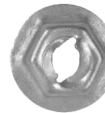

9847PK 3/16" Stud Size
3/8" Hex Size
1/2" Flange Diameter
Zinc Finish
Thread Cutting Nuts
Chrysler # 6006264

200 Pcs.



263PK 3/16" Stud Size
3/8" Hex Size
5/8" Flange Diameter
Zinc Finish
Thread Cutting Nuts

100 Pcs.



262PK 1/4" Stud Size
7/16" Hex Size
19/32" Flange Diameter
Zinc Finish
Thread Cutting Nuts

100 Pcs.



9226PK 1/4" Stud Size
7/16" Hex Size
11/16" Flange Diameter
Zinc Finish
Thread Cutting Nuts

100 Pcs.



856PK 5/16" Stud Size
1/2" Hex Size
7/8" Flange Diameter
Zinc Finish
Thread Cutting Nuts

50 Pcs.



Nuts Thread Cutting Metric

1040PK 4mm Stud Size
9mm Hex Size
15mm Flange Diameter
Zinc Finish
Thread Cutting Nuts

100 Pcs.





5

Specialty Nuts

Nuts Thread Cutting Metric

5	1041PK	5mm Stud Size 10mm Hex Size 15mm Flange Diameter Black Finish Thread Cutting Nuts G.M. # 11501835, 11508900, 11510062, 11501932 Ford # W707501-S300	50 Pcs.		
	1042PK	6.30mm Stud Size 11mm Hex Size 18mm Flange Diameter Zinc Finish Thread Cutting Nuts G.M. # 11501836, 11503432	50 Pcs.		
	1622PK	8mm Stud Size 13mm Hex Size 20mm Flange Diameter Zinc Finish Thread Cutting Nuts G.M. # 11502507, 11509535, 11514282	100 Pcs.		
	16368PK	8mm Stud Size 13mm Hex Size 20mm Flange Diameter Black Finish Thread Cutting Nuts	100 Pcs.		



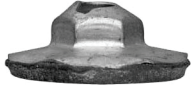



Nuts Lock Zinc Plated

11865PK	1/4-20 Screw Size 7/16" Hex Size 19/32" Flange Diameter Zinc Finish Washer Lock Nuts	100 Pcs.		
11140PK	6-1.00mm Stud Size 11mm Hex Size 24mm Flange Diameter Metallic Gray Finish With Sealer Locking Washer Nuts G.M. # 11505865	25 Pcs.		

Nuts Miscellaneous





18451PK	5mm Stud Size 10mm Hex 15mm Flange Zinc Finish Locking Teeth Emblem Nuts Ford # W706675-S439	50 Pcs.		
----------------	---	----------------	--	---

Nuts Hex Flange Type Standard









259PK	10-24 Screw Size 3/8" Hex Size 31/64" Outside Diameter Serrated Flange Bright Zinc Finish Hex Flange Nuts	100 Pcs.			
11331PK	10-24 Screw Size 3/8" Hex Size 31/64" Outside Diameter Serrated Flange Black Finish Hex Flange Nuts	100 Pcs.			

Specialty Nuts



Nuts Hex Flange Type Standard

9883PK	1/4-20 Screw Size 7/16" Hex Size 19/32" Outside Diameter Flange Black Nylon Hex Flange Nuts	50 Pcs.		
18316PK	3/8-16 (USS) Screw Size 9/16" Hex Size 29/32" Outside Diameter Flange Zinc Finish Serrated Flange Nuts	50 Pcs.		

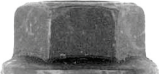

Nuts Hex Flange Type Metric

5797PK	5-.80mm Screw Size 8mm Hex Size 11.80mm Outside Diameter Flange Black Finish Metric Hex Flange Nuts G.M. # 11502722, 11502702	50 Pcs.		
5800PK	6-1.00mm Screw Size 10mm Hex Size 16mm Outside Diameter Serrated Flange Black Finish Metric Hex Flange Nuts	100 Pcs.		
11191PK	8-1.25mm Screw Size 13mm Hex Size 17mm Outside Diameter Flange Black Finish Metric Hex Flange Nuts G.M. # 11501889, 11507036, 11502609, 11514518, 11514596	25 Pcs.		
5805PK	8-1.25mm Screw Size 13mm Hex Size 19mm Outside Diameter Serrated Flange Black Finish Metric Hex Flange Nuts	100 Pcs.		
1017PK	10-1.50mm Screw Size 15mm Hex Size 21mm Outside Diameter Flange Black Finish Metric Hex Flange Nuts G.M. # 11501850	25 Pcs.		

Nuts Hex Loose Washer Standard

17921PK	1/4-20 Screw Size 7/16" Hex Size 5/8" Outside Diameter Loose Washer Yellow Zinc Finish Hex Nuts G.M. # 3866846 Ford # 385400, 45334 Chrysler # 6023204, 6025004, 6033560	50 Pcs.		
----------------	---	----------------	---	---

















Nuts Hex Loose Washer Metric

12053PK	5-.80mm Thread Size 8mm Hex Size 10mm Outside Diameter Loose Washer Yellow Zinc Finish Metric Hex Nuts Ford # N802775-S36	50 Pcs.		
----------------	--	----------------	---	---

5

Specialty Nuts

Nuts Hex Loose Washer Metric

1639PK	5-.80mm Screw Size 10mm Hex Size 15mm Outside Diameter Loose Washer Black Finish Metric Hex Nuts AMC # 4200408 Ford # N621903-S61, N621903-S2 G.M. # 11504614	50 Pcs.		
12892PK	5 - .80mm Screw Size 10mm Hex Size 19mm Outside Diameter Loose Washer Black Finish Metric Hex Nuts G.M. # 11504614	50 Pcs.		
5910PK	6-1.00mm Screw Size 10mm Hex Size 16mm Outside Diameter Loose Barbed Washer Black Finish Metric Hex Nuts G.M. # 11505329, 11503752 V.W. # N90100001	25 Pcs.		
13503PK	6-1.00mm Thread Size 10mm Hex Size 18mm Outside Diameter Loose Washer Black Finish Metric Hex Nuts Chrysler # 6100048, 6500284	50 Pcs.		
5915PK	6-1.00mm Screw Size 10mm Hex Size 19mm Outside Diameter Loose Barbed Washer Black Phosphate Finish Metric Hex Nuts Chrysler # 6100049, 34201358	25 Pcs.		
11896PK	6-1.00mm Screw Size 11mm Hex Size 19mm Outside Diameter Loose Washer Black Finish Metric Hex Nuts G.M. # 11503754, 11503756, 11505005, 11517293, 11609411	25 Pcs.		
12055PK	6-1.00mm Screw Size 11mm Hex Size 24mm O.D. Loose Washer Yellow Zinc Finish Metric Hex Nuts Ford # N621907, N621907-S55	25 Pcs.		
10838PK	8-1.25mm Screw Size 13mm Hex Size 18mm Outside Diameter Loose Barbed Washer Black Phosphate Finish Metric Hex Nuts Chrysler # 6100050	25 Pcs.		

5

Specialty Nuts

Nuts Hex Loose Washer Metric

5916XPK 8-1.25mm Screw Size
13mm Hex Size
24mm Outside Diameter
Loose Barbed Washer
Black Finish
Metric Hex Nuts
Ford # N621940-S424
G.M. # 11503695, 11506117, 11516780,
11500401

25 Pcs.



11909PK 10-1.50mm Screw Size
15mm Hex Size
24mm Outside Diameter Loose Washer
Black Finish
Metric Hex Nuts
Chrysler # 6100053
Ford # N621942-S301, N621942-S441,
N621942-S2

25 Pcs.



Nuts Short Type "J"

10053PK #6 (3.50mm) Screw Size
.090 - .110" Panel Range
9/32" Center of Hole to Edge
Black Finish
Short Type "J" Nuts

25 Pcs.



Nuts Speed Type "U" for Sheet Metal Screws

9892PK #6 (3.50mm) Screw Size
.025 - .125" Panel Range
3/8" Center of Hole to Edge
Black Finish
Speed Type "U" Nuts

50 Pcs.

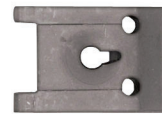

1350PK #8 (4.20mm) Screw Size
.020 - .150" Panel Range
3/8" Center of Hole to Edge
Black Finish
Speed Type "U" Nuts
Ford # 381818-S2, 15650655
G.M. # 9424837, 9431530, 15650655

100 Pcs.

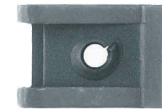

11136PK #8 (4.20mm) Screw Size
.025 - .125" Panel Range
3/8" Center of Hole to Edge
Black Finish
Speed Type "U" Nuts

25 Pcs.

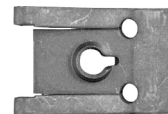

5750PK #8 (4.20mm) Screw Size
.025 - .150" Panel Range
5/8" Center of Hole to Edge
Black Finish
Speed Type "U" Nuts
Ford # 381863-S2
G.M. # 9440178, 9433155, 11504531

100 Pcs.

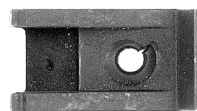

11040PK #8 (4.20mm) Screw Size
.045 - .062" Panel Range
3/8" Center Of Hole To Edge
Black Finish
Speed Type "U" Nuts
G.M. # 445429, 9422552

50 Pcs.



13350PK #8 (4.20mm) Screw Size
.50 - 2.50mm Panel Range
14mm Center Of Hole To Edge
Zinc Finish
Speed Type "U" Nuts
Mercedes # 123-994-08-45

25 Pcs.



1510PK #8 (4.20mm) Screw Size
.125 - .250" Panel Range
3/8" Center of Hole to Edge
Black Finish
Speed Type "U" Nuts
G.M. # 9433156











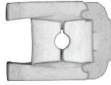



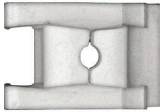



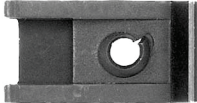

100 Pcs.

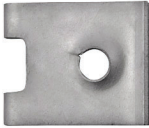

5

Specialty Nuts









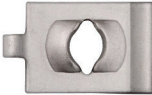

Nuts Speed Type "U" for Sheet Metal Screws

16076PK	#8 (4.20mm) Screw Size 2.00 - 3.40mm Panel Range 9.50mm Center of Hole to Edge Zinc Organic Finish Metric "U" Nuts Ford # W708991-S439	25 Pcs.		 NEW!
11954PK	#8 (4.20mm) Screw Size 3 - 4mm Panel Range 7mm Center of Hole to Edge Zinc Finish Speed Type "U" Nuts BMW # 0712-9-925-708 Mercedes # 000-994-25-45	50 Pcs.		
18795PK	#8 (4.20-1.41mm) Screw Size 0.50 - 1.80mm Panel Range 7.92mm Center of Hole to Edge Zinc Finish Bumper Cover & Wheel Moulding U-Nuts Ford # W704277-S496	25 Pcs.		 NEW!
5751PK	#10 (4.80mm) Screw Size .025 - .150" Panel Range 11/32" Center of Hole to Edge Black Finish Speed Type "U" Nuts	25 Pcs.		
5752PK	#10 (4.80mm) Screw Size .025 - .150" Panel Range 19/32" Center of Hole to Edge Black Finish Speed Type "U" Nuts	50 Pcs.		
11286PK	#10 (4.80mm) Screw Size .50 - 1.70mm Panel Range 7mm Center of Hole to Edge Zinc Finish Speed Type "U" Nuts BMW # 0712-9-925-737, 07-12-9-901-651 Mercedes # 000-994-06-45, 003-994-30-45	50 Pcs.		
13301PK	#10 (4.80mm) Screw Size .80 - 1.70mm Panel Range 11mm Center of Hole to Edge Zinc Finish Speed Type "U" Nuts BMW # 0711-9-916-945, 07-11-9-901-294, 07-11-9-901-299 Mercedes # 000-994-14-45	50 Pcs.		
11915PK	#10 (4.80mm) Screw Size .90 - 2mm Panel Range 8mm Center of Hole to Edge Zinc Finish Speed Type "U" Nuts Mercedes # 000-994-14-45	25 Pcs.		
13434PK	#10 (4.80mm) Screw Size 2.30 - 3.50mm Panel Range 8.50mm Center of Hole to Edge Zinc Finish Speed Type "U" Nuts BMW # 07129904150	25 Pcs.		
17089PK	5 - 1.81mm Screw Size 2.00 - 3.50mm Panel Range 8.00mm Center of Hole to Edge Zinc Finish "U" Nuts Use With # 10246 Acura # 90331-S3Y-003 Honda # 90331-S3Y-003	50 Pcs.		 NEW!

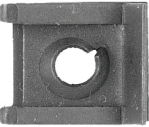
5

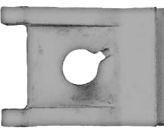

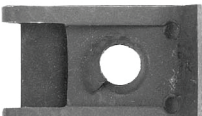



Specialty Nuts

Nuts Speed Type "U" for Sheet Metal Screws



10246PK	5 - 1.81 x 20mm Phillips Flat Top 13mm Head Diameter Black Finish Trim Screws Honda 90103-SDA-A00, 90103-TA0-000	100 Pcs.		
18881PK	#14 (6-1.81mm) Screw Size 1.50mm Panel Range 10mm Center of Hole to Edge Zinc Finish Speed Type "U" Nuts Hyundai # 13355-06016 Kia # 13355-06016			
1192PK	#14 (6.30mm) Screw Size .025 - .150" Panel Range 3/8" Center of Hole to Edge Black Finish Speed Type "U" Nuts G.M. # 9431532	25 Pcs.		
11128PK	#14 (6.30mm) Screw Size .025 - .150" Panel Range 3/8" Center of Hole to Edge Zinc Organic Finish Speed Type "U" Nuts Nissan # 08967-1065A	25 Pcs.		
5753PK	#14 (6.30mm) Screw Size .025 - .150" Panel Range 5/8" Center of Hole to Edge Black Finish Speed Type "U" Nuts	25 Pcs.		

5

Nuts Speed Type "U" for Machine Screws

9866PK	8-32 Screw Size .110 - .125" Panel Range 9/32" Center of Hole to Edge Black Finish Speed Type "U" Nuts	25 Pcs.		
9897PK	10-24 Screw Size .045 - .062" Panel Range 17/32" Center of Hole to Edge Black Finish Speed Type "U" Nuts	100 Pcs.		
9848PK	1/4-20 Screw Size .064 - .125" Panel Range 9/16" Center of Hole to Edge Black Finish Speed Type "U" Nuts G.M. # 9431647, 22529733	100 Pcs.		

Nuts Extruded Type "U" Standard

938PK	10-24 Screw Size .025 - .125" Panel Range 15/32" Center of Hole to Edge Black Finish Extruded "U" Nuts Chrysler # 149251 G.M. # 152273	50 Pcs.		
938ZPK	10-24 Screw Size .025 - .125" Panel Range 15/32" Center of Hole to Edge Bright Zinc Finish Extruded "U" Nuts	50 Pcs.		

Specialty Nuts

Nuts Extruded Type "U" Standard







2969PK	1/4-20 Screw Size .010 - .165" Panel Range 17/32" Center of Hole to Edge Black Finish Extruded "U" Nuts Ford # 45263-S2 G.M. # 1494252, 1480627	25 Pcs.		
2969ZYPK	1/4-20 Screw Size .010 - .165" Panel Range 17/32" Center of Hole to Edge Yellow Zinc Finish Extruded "U" Nuts	25 Pcs.		
5480PK	1/4-20 Screw Size .010 - .165" Panel Range 25/32" Center of Hole to Edge Black Finish Extruded "U" Nuts Ford # 45267 G.M. # 1494257	25 Pcs.		
1835PK	5/16-18 Screw Size .025 - .125" Panel Range 5/8" Center of Hole to Edge Black Finish Extruded "U" Nuts Chrysler # 6023171 Ford # 45264 G.M. # 1494253	25 Pcs.		
1836PK	5/16-18 Screw Size .010 - .170" Panel Range 27/32" Center of Hole to Edge Black Finish Extruded "U" Nuts Ford # 379831-S G.M. # 1494258, 10008002, 12338146, 45268-S2	25 Pcs.		
5412PK	3/8-16 Screw Size .035 - .205" Panel Range 3/4" Center of Hole to Edge Black Finish Extruded "U" Nuts Ford # 45265-S2 G.M. # 1494254, 12337873	25 Pcs.		
5466PK	3/8-16 Screw Size .035 - .220" Panel Range 1 1/8" Center of Hole to Edge Black Finish Extruded "U" Nuts Ford # 45269, 45269-S	25 Pcs.		
			Not Actual Size	
16095PK	6-1.00mm Screw Size .50mm - 4.00mm Panel Range 13mm Center of Hole to Edge Silver Finish Extruded "U" Nuts Chrysler # 6105242-AA	25 Pcs.		

Hardware Skid Plate

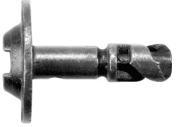
16990PK	4.50mm Stud Size 13mm Center of Hole to Edge Zinc Finish Skid Plate "U" Nuts Use With # 16991 Audi # 8K0-805-922A	15 Pcs.		
----------------	--	---------	--	--









Specialty Nuts

Hardware Skid Plate

16991PK	11/64" (4.50mm) Hole Size 18.50mm Stem Length 16mm Head Diameter Black Finish Phillips Drive Cowl Fasteners Use With #16990 V.W. # 8K0-805-121	10 Pcs.		
13254PK	6mm Stud Size 12.20mm Center of Hole to Edge Zinc Finish Speed Type "U" Nuts For Nylon Screws Use With # 13253 & 1655 V.W. # 8D0805960	10 Pcs.		
1655PK	8mm Bolt Size 8.40mm Inside Diameter 17mm Outside Diameter Bright Zinc Finish Metric Flat Washers Use With # 13253 & 13254	100 Pcs.		
13253PK	9/32" (7mm) Hole Size 20mm Stem Length 18mm Head Diameter Black Finish Steel Slotted Drive Cowl Fasteners Use With # 13254 & 1655 V.W. # 8D0-805-121B	10 Pcs.		

5



Nuts Splash Shield Retaining Metric

15730PK	5mm Stud Size 30mm Outside Diameter Flange Dacromet Finish Splash Shield & Wheel Well Push Type Retainers V.W. # N90-335-006	25 Pcs.		
13260PK	5-2.12x19mm 14mm Head Diameter T25 Drive Size Black Finish Torx® Truss Head Screws Use with #10937 & 13256 V.W. # N90892001, N90775001	25 Pcs.		
10937PK	5mm Torx Screw Size 30mm Outside Diameter Flange Zinc Finish Splash Shield Retainers Use with #13260 & 13256 V.W. # N90-796-502, N90-335-004	25 Pcs.		
13256PK	5-2.12 Screw Size 8mm Stem Length 7.50 x 13mm Hole Size Zinc Finish Splash Shield Retaining Nuts Use with # 13260 & 10937 V.W. # N10327101, N10327102	25 Pcs.		

Specialty Nuts



Nuts Splash Shield Retaining Metric

17932PK	14mm Hex Size 30mm Flange Diameter Black Nylon Wheel Well Liner & Splash Shield Nuts Hyundai # 84145-26000	15 Pcs.		
----------------	---	----------------	--	---

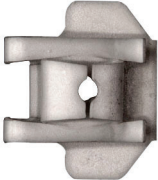

15868PK	8.50mmx11.00mm Hole Size 36mm Stem Length 18mm Head Diameter Black Nylon Rocker Panel & Splash Shield Screw Grommet With Specialty Screw Chrysler # 6510123AA	5 Pcs.		
----------------	---	---------------	--	---

Nuts Extruded Type "U" Metric

5

11981PK	#8 (4.20-1.41mm) Screw Size 9.50mm Center of Hole to Edge 1.80 - 3.50mm Panel Range Zinc Organic Extruded "U" Nuts Ford # W716567-S439	25 Pcs.		
----------------	---	----------------	--	---



16078PK	#8 (4.20-1.41mm) Screw Size 9.50mm Center of Hole to Edge 2.00 - 3mm Panel Range Zinc Organic Prevailing Torque Extruded "U" Nuts G.M. # 11548579	25 Pcs.		
----------------	--	----------------	---	--

10726PK	#8 (4.20-1.41mm) Screw Size 10mm Center of Hole to Edge .50 - 2.00mm Panel Range Zinc Organic Prevailing Torque Extruded "U" Nuts G.M. # 11516397 Ford # W707291-S439	50 Pcs.		
----------------	---	----------------	--	---

11339PK	#8 (4.20-1.41mm) Screw Size 10.10mm Center of Hole to Edge 2.00 - 3mm Panel Range Prevailing Torque 6.28 In-lbs Black Finish Extruded "U" Nuts G.M. # 11513700	25 Pcs.		
----------------	--	----------------	--	---



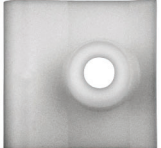







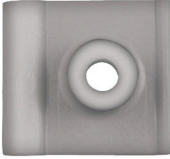

11043PK	#8 (4.20-1.41mm) Screw Size 15mm Center of Hole to Edge .65 - 3.80mm Panel Range Zinc Organic Prevailing Torque Extruded "U" Nuts G.M. # 11515638	25 Pcs.		
----------------	--	----------------	--	---

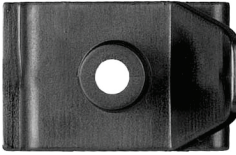
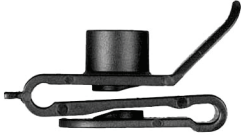
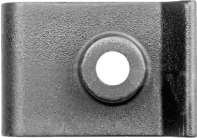
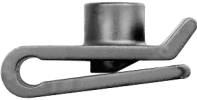
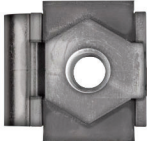
1021PK	4-.70mm Screw Size 13.50mm Center of Hole to Edge .80 - 4mm Panel Range Black Finish Extruded "U" Nuts G.M. # 11500655	50 Pcs.		
---------------	---	----------------	--	---

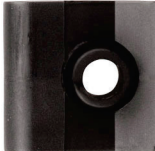
12898PK	#10 (4.80mm) Screw Size Up to 1.50mm Panel Range 8mm Center of Hole to Edge White Nylon "U" Type Nuts Nissan # 76882-0M000	15 Pcs.		
----------------	---	----------------	--	---

Specialty Nuts









Nuts Extruded Type "U" Metric

15214PK	#10 (4.80mm) Screw Size Up to 1.00mm Panel Range 11mm Center of Hole to Edge Gray Nylon "U" Type Nuts Mazda # B455-56-135	25 Pcs.		
18105PK	#10 (4.80mm) Screw Size Up to 1.00mm Panel Range 11mm Center of Hole to Edge Gray Nylon Front Bumper "U" Type Nuts Mazda # C274-50-133	25 Pcs.		
1601PK	#10 (4.80mm) Screw Size Up to 1.00mm Panel Range 11mm Center of Hole to Edge Black Nylon Fender Wheel Housing "U" Type Nuts G.M. # 94841226 Mazda LA01-56-135 Toyota # 53879-14010-A, 53879-14020, 53879-22030	15 Pcs.		
12494PK	#10 (4.80mm) Screw Size Up to 3mm Panel Range 14mm Center of Hole to Edge Black Nylon "U" Type Nuts Toyota # 90179-05060	10 Pcs.		
17941PK	5.00- .80mm Screw Size Panel Range Up to 3mm Center of Hole to Edge 10mm Black Nylon With Metal Insert Splash Guard "U" Nuts Subaru # 91086AA000	10 Pcs.		
11161PK	#12 (5.50mm) Screw Size Up to 1.00mm Panel Range 9mm Center of Hole to Edge Black Nylon "U" Type Nuts Nissan # 63848-D0100	15 Pcs.		
9530PK	#12 (5.50mm) Screw Size Up to 2mm Panel Range 9mm Center of Hole to Edge Black Nylon Inner Fender "U" Type Nuts Nissan # 63848-D4000, 63848D4001	10 Pcs.		
15729PK	#12 (5.50mm) Screw Size Up To 2mm Panel Range 12mm Center Of Hole to Edge Red Nylon "U" Type Nuts Use With # 10123 G.M. # 24449408	25 Pcs.		

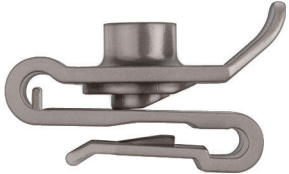

5

Specialty Nuts







Nuts Extruded Type "U" Metric

10123PK	5.50 x 20mm Torx® Truss Head 15mm Outside Diameter Washer Black Zinc Finish Screws Use With # 15729 G.M. # 13144822	25 Pcs.		
11421PK	#12 (5.50mm) Screw Size Up to 1.00mm Panel Range 14mm Center of Hole to Edge Black Nylon "U" Type Nuts Toyota # 90467-05114	10 Pcs.		
1012PK	5-.80mm Screw Size 8mm Center of Hole to Edge .80 - 4mm Panel Range Black Finish Extruded "U" Nuts G.M. # 11500657, 11504693	50 Pcs.		
12893PK	5-.80mm Screw Size 11mm Center of Hole to Edge .60 - 3.80mm Panel Range Black Finish Extruded "U" Nuts Ford # N623331-S2, W520821-S439, W520821-S426 G.M. # 11505596, 11500656	50 Pcs.		
18893PK	6-1.00 Screw Size 1.50mm Panel Range 8mm Center of Hole to Edge Black Finish Bumper Cover Extruded 'U' Nuts Hyundai # 13341-06007-B Kia # 13341-06007-B	25 Pcs.		

Nuts Nylon "U" Type with Metal Insert Metric



















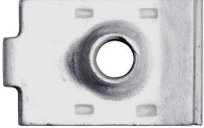

16369PK	6-1.00 Screw Size 3.50mm Panel Range 13.50mm Center of Hole to Edge Black Nylon & Black Metal License Plate Bracket "U" Nuts	25 Pcs.		
----------------	--	----------------	--	---

Nuts Extruded Type "U" Metric

16400PK	6-1.00mm Screw Size 9mm Center of Hole to Edge 1.80 - 2.50mm Panel Range Zinc Finish Extruded "U" Nuts Ford # N806728-S439 G.M. # 11517841	15 Pcs.		
16365PK	6-1.00 Screw Size 9.20mm Center of Hole to Edge 1.80 - 2.20mm Panel Range Zinc Organic Extruded "U" Nuts Chrysler # 68073566AA	15 Pcs.		
16328PK	6-1.00 Screw Size 12mm Center of Hole to Edge .70 - 2.00mm Panel Range Zinc Finish Extruded "U" Nuts Ford # W712324-S439	10 Pcs.		

Specialty Nuts

Nuts Extruded Type "U" Metric

16079PK	6-1.00mm Screw Size 13.50mm Center of Hole to Edge .80 - 4.00mm Panel Range Zinc Organic Extruded U Nuts Ford # W520822-S439 Chrysler # 6510185-AA, 6101956, 6503694	25 Pcs.		
10836PK	6-1.00mm Screw Size 13.50mm Center of Hole to Edge .80 - 4.00mm Panel Range Black Phosphate Organic Finish Prevailing Torque Extruded "U" Nuts Chrysler # 6101308 Ford # N800854-S1 G.M. # 11509005	25 Pcs.		
5596PK	6-1.00mm Screw Size 13.50mm Center of Hole to Edge .80 - 4.00mm Panel Range Black Finish Extruded "U" Nuts Ford # N623332, N623332-S2, N623332-S53, N623332-S100 G.M. # 11503957, 11503716, 1016937	25 Pcs.		
9512PK	6-1.00mm Screw Size 13.50mm Center of Hole to Edge 3.40 - 6.30mm Panel Range Black Finish Extruded "U" Nuts Ford # N802331-S53 G.M. # 11504047	25 Pcs.		
9949PK	6-1.00mm Screw Size 14mm Center of Hole to Edge .50 - 2.30mm Panel Range GM 4435-M Finish Prevailing Torque Extruded "U" Nuts G.M.	25 Pcs.		
16081PK	6-1.00mm Screw Size 14mm Center of Hole to Edge .70 - 2.00mm Panel Range Zinc Organic Extruded "U" Nuts G.M. # 11611321	10 Pcs.		
11030PK	6-1.00mm Screw Size 14mm Center of Hole to Edge .80 - 2.00mm Panel Range Zinc Organic Extruded "U" Nuts G.M. # 11570097	15 Pcs.		
16471PK	6-1.00mm Screw Size 14.50mm Center of Hole to Edge .50 - 2.30mm Panel Range Zinc Organic Extruded "U" Nuts Ford # W705958-S439	10 Pcs.		
13432PK	6-1.00mm Screw Size 14.50mm Center of Hole to Edge 2.00 - 4.00mm Panel Range Zinc Finish Extruded "U" Nuts Honda # 90675-SA5-003	25 Pcs.		
5650PK	6-1.00mm Screw Size 19.50mm Center of Hole to Edge 1.00 - 2.50mm Panel Range Black Finish Extruded "U" Nuts Ford # W520832-S424, W520832-S426 G.M. # 11503715, 11506099, 11508241	25 Pcs.		

Specialty Nuts

Nuts Extruded Type "U" Metric

5559PK	6.3-1.00mm Screw Size 13.50mm Center of Hole to Edge .80 - 4.00mm Panel Range Black Finish Extruded "U" Nuts G.M. # 11500658, 9433043, 11502785	25 Pcs.		
10785PK	#14 (6.30mm) Screw Size 8mm Center of Hole to Edge Up to 1.50mm Panel Range Black Nylon Wheel Guard "U" Type Nuts Hyundai # 86825-28800	25 Pcs.		
11388PK	#14 (6.30mm) Screw Size 12mm Center of Hole to Edge Up to 2mm Panel Range Dark Red Nylon Front Bumper "U" Type Nuts Toyota # 90467-A0018, 90467-05081, 90084-46019	15 Pcs.		
15083PK	#14 (6.30mm) Screw Size Up to 3mm Panel Range 14mm Center of Hole to Edge Black Nylon Front Bumper & Fender Liner "U" Type Nuts Toyota # 90467-05138	15 Pcs.		
Not Actual Size				
1606PK	#14 (6.30mm) Screw Size Up to 1.00mm Panel Range 15mm Center of Hole to Edge Black Nylon Fender Wheel Housing "U" Type Nuts Toyota # 53879-22010	15 Pcs.		
16075PK	8-1.25mm Screw Size .80 - 4.00mm Panel Range 14.5mm Center of Hole to Edge Zinc Finish Extruded "U" Nuts Ford # W520823-S439, N800296-S439	15 Pcs.		
5560PK	8-1.25mm Screw Size 14.50mm Center of Hole to Edge .80 - 4.00mm Panel Range Black Finish Extruded "U" Nuts Chrysler # 6100042, 6101283 Ford # N623333-S2, N623333-S100 G.M. # 11500660, 11508925, 11502617	25 Pcs.		
5557PK	8-1.25mm Screw Size 20mm Center of Hole to Edge .80 - 4.50mm Panel Range Black Finish Extruded "U" Nuts Ford # N623343-S100, N623343-S2 G.M. # 11500661, 11503317, 11516150	25 Pcs.		
16080PK	8-1.25 Screw Size 21mm Center of Hole to Edge .80 - 4.00mm Panel Range Zinc Organic Extruded "U" Nuts Ford # W520813-S439 G.M. # 11516150	15 Pcs.		

Specialty Nuts

Nuts Extruded Type "U" Metric

16099PK	8-1.25mm Screw Size 3mm Panel Range 27.30mm Center of Hole to Edge Silver Magni Finish Fender Panel Extruded "U" Nuts G.M. # 11569971	5 Pcs.		
			Not Actual Size	
5558PK	10-1.50mm Screw Size 19mm Center of Hole to Edge .90 - 6.00mm Panel Range Black Finish Extruded "U" Nuts G.M. # 11500662, 22531616	25 Pcs.		

Retainers Grommets

16380PK	2.50mm Stud Size 8mm Head Diameter 6mm Hole Size Clear Nylon With Sealer Emblem Tubular Nuts Mazda # LA01-51-958	25 Pcs.		
----------------	---	----------------	--	--

5

Nuts Nylon

9665PK	#4 (2.80mm) Screw Size 16mm Stem Length 12mm Head Diameter 7.00 x 7.00mm Square Hole White Nylon With Sealer Screw Grommets Nissan # 01281-01121	10 Pcs.		
11414PK	#4 (2.90mm) Screw Size 7mm Stem Length 13mm Head Size 8.40 x 8.60mm Hole Size Natural Nylon Door Trim Grommets Honda # 90866-SA0-000	25 Pcs.		
12634PK	#4 (2.90mm) Screw Size 14mm Stem Length 9mm Head Size 7mm Hole Size Natural Nylon Side Moulding Screw Grommets Lexus # 90189-04207	25 Pcs.		
2157PK	#4 (2.90mm) Screw Size 17mm Stem Length 13mm Head Diameter 7mm Hole Size Natural Nylon Center Pillar Screw Grommets Honda # 91620-SR2-003	10 Pcs.		
11193PK	#6 (3.50mm) Screw Size 6.50mm Stem Length 9.60mm Head Size 6.00 x 6.50mm Hole Size Natural Nylon With Sealer Rear Bumper Grommets G.M. # 11589183	50 Pcs.		
16473PK	#6 (3.50mm) Screw Size 7mm Stem Length 10mm Head Size 7.00 x 7.00mm Hole Size White Nylon Screw Grommets Toyota # 81137-22530, 90075-10004, 81150-1A750	25 Pcs.		



















Specialty Nuts

Nuts Nylon

18855PK	#6 (3.50mm) Screw Size 7mm Stem Length 12mm Head Diameter 8.50mm Hole Size Natural Nylon License Plate Screw Grommets Hyundai # 14910-04000, 92561-25000	25 Pcs.		
10808PK	#6 (3.50mm) Screw Size 7mm Stem Length 12.00 x 18.00mm Head Size 6.00 x 14.00mm Hole Size White Nylon Rocker Trim Screw Grommets Lexus # 90189-04059	25 Pcs.		
1297PK	#6 (3.50mm) Screw Size 5/16" Stem Length 13/32" Head Size 9/32" Hole Size Natural Nylon Headlight Screw Grommets Chrysler # 6029501 G.M. # 1370853 V.W. # 179-813-883, 155-809-966	50 Pcs.		
9112PK	#6 (3.50mm) Screw Size 8mm Stem Length 12mm Head Size 7.00 x 7.50mm Hole Size Natural Nylon Screw Grommets Toyota # 90189-04011, 90189-04057	25 Pcs.		
1978PK	#6 (3.50mm) Screw Size 8mm Stem Length 12.00 x 16.00mm Head Size 6.00 x 10.00mm Hole Size Natural Nylon Screw Grommets Isuzu # 8941340270 Toyota # 90189-05012	50 Pcs.		
9873PK	#6 (3.50mm) Screw Size 8mm Stem Length 12.50mm Head Diameter 7.00 x 7.50mm Hole Size Natural Nylon Headlight Door to Radiator Grille Grommets G.M. # 1355003	50 Pcs.		
1227PK	#6 (3.50mm) Screw Size 8.50mm Stem Length 9.00 x 13.00mm Head Size 6.50 x 9.00mm Hole Size Black Nylon Front Fender Screw Grommets Ford # N-800503S	50 Pcs.		
9111PK	#6 (3.50mm) Screw Size 8.50mm Stem Length 10mm Head Size 6.50 x 7.50mm Hole Size Natural Nylon Headlight Screw Grommets AMC # 400141 G.M. # 380382 Mitsubishi # MS480001	50 Pcs.		
1202PK	#6 (3.50mm) Screw Size 8.50mm Stem Length 13.00 x 17.00mm Head Size 7.00 x 15.00mm Hole Size Natural Nylon Grille Attachment Screw Grommets G.M. # 14032291	50 Pcs.		

Specialty Nuts

Nuts Nylon

637PK	#6 (3.50mm) Screw Size 9mm Stem Length 14.00 x 21.00mm Head Size 7.00 x 18.50mm Hole Size Natural Nylon Rear Bumper Bar Screw Grommets G.M. # 1377030	100 Pcs.		
9085PK	#6 (3.50mm) Screw Size 3/8" Stem Length 15/64 x 23/64" Head Size 15/64" Hole Size White Nylon Marker Light Screw Grommets G.M. # 1254815	50 Pcs.		
15148PK	#6 (3.50mm) Screw Size 9.50mm Stem Length 11.50mm Head Diameter 7mm Hole Size Natural Nylon Screw Grommets Nissan # 96706-H2500	25 Pcs.		
11147PK	#6 (3.50mm) Screw Size 10mm Stem Length 12mm Head Diameter 6.60mm Hole Size Gray Nylon With Sealer Rear Hatch Screw Grommets Acura # 91601-STX-A00	10 Pcs.		
9591PK	#6 (3.50mm) Screw Size 10mm Stem Length 14mm Head Diameter 7mm Hole Size Natural Nylon With Sealer Screw Grommets Honda # 90662-693-0030, 90662-693-003, 90662-693-0031 Toyota # 90189-04066	25 Pcs.		
17939PK	#6 (3.50mm) Screw Size 12mm Stem Length 8.00 x 10.00mm Head Size White Nylon Bumper Grommet Hyundai # 86518-3M000	25 Pcs.		
10619PK	#6 (3.50mm) Screw Size 12mm Stem Length 12.00 x 16.00mm Head Size Blue Nylon With Sealer Windshield Moulding Grommets Nissan # 76848-50Y00	10 Pcs.		
13344PK	#6 (3.50mm) Screw Size 14mm Stem Length 9.50mm Head Size 6.50 x 7.00mm Hole Size Black Nylon Cowl Vent Nuts Mercedes # 639-998-01-85 Replaces # 000-988-16-25	25 Pcs.		
1636PK	#6 (3.50mm) Screw Size 15mm Stem Length 14.50mm Head Diameter 7mm Hole Size Natural Nylon Screw Grommets Honda # 90672-671-8110M1 Toyota # 90189-04013	25 Pcs.		

5

Specialty Nuts

Nuts Nylon

10715PK	#6 (3.50mm) Screw Size 16mm Stem Length 22.00 x 23.50mm Head Size 15mm Hole Size Black Nylon Headlight Screw Grommets Ford # W712160-S300	15 Pcs.		
2156PK	#6 (3.50mm) Screw Size 16.50mm Stem Length 8mm Head Size 7mm Hole Size Natural Nylon With Sealer Body Side Screw Grommets Nissan # 01281-00501	15 Pcs.		
1407PK	#6 (3.50mm) Screw Size 16.50mm Stem Length 14.70 x 20.80mm Head Size 7.10 x 20.30mm Hole Size Black Nylon High Torque Screw Grommets AMC # 8934-201-602 Chrysler # 6031869 G.M. # 10032838, 1264963	25 Pcs.		

Retainers Grommets

16359PK	4mm Screw Size 11/32" (8.50mm) Hole Size 9.70mm Stem Length 9.50mm Flange Diameter Gray Nylon With Sealer Screw Grommets Honda # 90656-SJK-J01	15 Pcs.		
----------------	--	----------------	--	--

















Nuts Nylon

11863PK	#6 to #8 Screw Size 8.30mm Stem Length 11.00 x 13.60mm Head Size Black Nylon Cowl Vent Nuts Chrysler # 6035274 G.M. # 15596280	25 Pcs.		
18794PK	#8 (4.20mm) Screw Size 5mm Stem Length 12.75mm Head Diameter 7.87mm Square Hole Size White Nylon Grille Trim Screw Grommets Ford # W711612-S300	25 Pcs.		
11185PK	#8 (4.20mm) Screw Size 5mm Stem Length 15mm Head Diameter 8mm Hole Size Gray Nylon Rear Bumper Fascia Grommets Honda # 90651-SL9-013, 90651-SL9-0130	15 Pcs.		
10993PK	#8 (4.20mm) Screw Size 6.40mm Stem Length 10.00 x 16.00mm Head Size 7.00 x 11.40mm Hole Size Black Nylon Front Fascia Grommets Honda # 90107-SOX-A01	15 Pcs.		

5

Specialty Nuts



Nuts Nylon

15038PK	#8 (4.20mm)Screw Size 6.50mm Stem Length 9.50mm Head Size 7.00 x 7.00mm Hole Size Black Nylon Side Marker Light Screw Grommet Honda # 75522-611-000 Mazda # 9991-00-412 Mitsubishi # MS-480001	50 Pcs.		
1577PK	#8 (4.20mm) Screw Size 6.50mm Stem Length 10mm Head Size 6.00 x 7.00mm Hole Size Natural Nylon Side Marker Light Screw Grommets Honda # 75522-611-000, 75522-611-0000 Mazda # 9991-00-412 Mitsubishi # MS-480001 Nissan # 96706-B0700, 97606-B0700 Toyota # 90189-04042, 95900-04036	50 Pcs.		
2940PK	#8 (4.20mm) Screw Size 17/64" Stem Length 31/64" Head Size 5/16" Hole Size Natural Nylon Headlamp Screw Grommets G.M. # 14013246	50 Pcs.		
9050PK	#8 (4.20mm) Screw Size 17/64" Stem Length 17/32" Head Size 11/32" Hole Size Natural Nylon Grille Screw Grommets G.M.	50 Pcs.		
12902PK	#8 (4.20mm) Screw Size 7mm Stem Length 10mm Head Size 7mm Hole Size Natural Nylon Screw Grommets Toyota # 90189-04014	50 Pcs.		
1574PK	#8 (4.20mm) Screw Size 9/32" Stem Length 7/16" Head Size 5/16" Hole Size Natural Nylon Grille Screw Grommets G.M. # 3919773, 22649878, 22649879	100 Pcs.		
2980PK	#8 (4.20mm) Screw Size 9/32" Stem Length 7/16" Head Size 5/16" Hole Size Natural Nylon Grille Screw Grommets G.M. # 3893980, 347347	50 Pcs.		
1997PK	#8 (4.20mm) Screw Size 8mm Stem Length 13mm Head Diameter 7.50mm Hole Size Black Nylon Tail Light Screw Grommets G.M. # 3997391 V.W. # 179-813-881	25 Pcs.		

5

Specialty Nuts



Nuts Nylon



11143PK	#8 (4.20mm) Screw Size 8mm Stem Length 17mm Head Diameter 9mm Hole Size Natural Nylon Headlight Mounting Nuts Toyota # 90189-05142	25 Pcs.		
----------------	--	----------------	--	---



Retainers Grommets

16399PK	23/64" (9mm) Hole Size 8mm Stem Length 17mm Head Diameter Yellow Nylon Headlamp Assembly Grommets Toyota # 90189-06238	25 Pcs.		
----------------	---	----------------	--	---



Nuts Nylon



12667PK	#8 (4.20mm) Screw Size 8.50mm Stem Length 9.70mm Head Diameter 6.50 x 7.50mm Hole Size Natural Nylon With Sealer Screw Grommets G.M. # 9669486 Renault # 8934-201-262	25 Pcs.		
----------------	--	----------------	--	---

9113PK	#8 (4.20mm) Screw Size 9mm Stem Length 10mm Head Size 7mm Hole Size Natural Nylon Radiator Grille Screw Grommets Chrysler # 6000943 Renault # 8934-201-263	100 Pcs.		
---------------	---	-----------------	--	---

12465PK	#8 (4.20mm) Screw Size 9.50mm Head Size 6mm Hole Size White Nylon Screw Grommets Honda # 34301-692A-0000	50 Pcs.		
----------------	---	----------------	--	---

9683PK	#8 (4.20mm) Screw Size 9mm Stem Length 12.00 x 12.00mm Square Head 10mm Hole Size Natural Nylon Door Handle Nuts Hyundai # 14910-05000	25 Pcs.		
---------------	--	----------------	--	---

11898PK	#8 (4.20mm) Screw Size 10mm Stem Length 12.50 x 14.50mm Head Size Black Nylon Radiator Grille Nuts Chrysler # 6031234	25 Pcs.		
----------------	--	----------------	--	---



















10783PK	#8 (4.20mm) Screw Size 10mm Stem Length 14mm Head Size 8.00 x 12.00mm Hole Size White Nylon With Sealer Body Moulding Screw Grommets Hyundai #87756-3D000	15 Pcs.		
----------------	---	----------------	--	---

10922PK	#8 (4.20mm) Screw Size 10mm Stem Length 14.50 x 16.70mm Head Size Maroon Nylon Scuff Plate Screw Grommets V.W. # 1J0-853-120	15 Pcs.		
----------------	---	----------------	--	---

5

Specialty Nuts

Nuts Nylon

10636PK	#8 (4.20mm) Screw Size 10mm Stem Length 16mm Head Diameter 8.50mm Hole Size Natural Nylon Screw Grommets	25 Pcs.		
9688PK	#8 (4.20mm) Screw Size 10mm Stem Length 16mm Head Diameter 9mm Hole Size Natural Nylon Bumper, Fender & Light Screw Grommets Nissan # 01281-00831	25 Pcs.		
18856PK	#8 (4.20mm) Screw Size 10mm Stem length 16mm Head Diameter 9mm Hole Size Black Nylon Door Trim Panel Screw Grommets Chrysler # 6035401	25 Pcs.		
10548PK	#8 (4.20mm) Screw Size 10mm Stem Length 16mm Head Size 9mm Hole Size Natural Nylon Door Trim Panel Screw Grommets Chrysler # 6035401	25 Pcs.		
10668PK	#8 (4.20mm) Screw Size 3/8" Stem Length 5/8" Head Size 11/32" Hole Size Tan Nylon With Sealer Tail Light Screw Grommets Chrysler # 6505703AA	15 Pcs.		
12021PK	#8 (4.20mm) Screw Size 13/32" Stem Length 3/8" Head Size Black Nylon Screw Grommets Chrysler # 6033677 Ford # 379830-S, 383356-S	25 Pcs.		
1842PK	#8 (4.20mm) Screw Size 13/32" Stem Length 3/8" Head Size 1/4" Hole Size Natural Nylon Grille Screw Grommets Ford # 379830-S	50 Pcs.		
10553PK	#8 (4.20mm) Screw Size 13/32" Stem Length 1/2" x 21/32" Head Size 19/64" x 15/32" Hole Size Black Nylon Door Panel & Fender Shield Screw Grommets Chrysler # 6035821 G.M. # 11517759	25 Pcs.		
10918PK	#8 (4.20mm) Screw Size 11mm Stem Length 7.00 x 12.00mm Head Size 7mm Hole Size Black Nylon Inside Fender Screw Grommets V.W. # 811-807-577C	25 Pcs.		

5













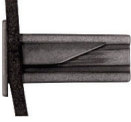

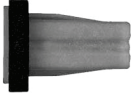

Specialty Nuts

Nuts Nylon

10556PK	#8 (4.20mm) Screw Size 11mm Stem Length 10mm Head Size 6.70mm Hole Size Natural Nylon Door Reveal Screw Grommets Ford # W710362 G.M. # 25647358	25 Pcs.		
9681PK	#8 (4.20mm) Screw Size 12mm Stem Length 11.50mm Hole Size Gray Nylon With Sealer Trim Moulding Grommets Hyundai # 87759-3S000	10 Pcs.		
11264PK	#8 (4.20mm) Screw Size 12mm Stem Length 20mm Head Diameter 9mm Hole Size Black Nylon Fender Apron Grommets Honda # 90682-SEA-003	25 Pcs.		
15308PK	#8 (4.20mm) Screw Size 13mm Stem Length 11mm Head Diameter 6.50 x 8.00mm Hole Size Natural Nylon Screw Grommets V.W. # 165-827-592	25 Pcs.		
12478PK	#8 (4.20mm) Screw Size 13mm Stem Length 15mm Head Diameter Black Nylon Fender Apron Screw Grommet V.W. # N908-338-01	15 Pcs.		
10384PK	#8 (4.20mm) Screw Size 13mm Stem Length 23.20mm Square Head Size 10.00 x 14.00mm Hole Size White Nylon Cowl Vent Grommets Ford # N807189-S100, N811353-S100	10 Pcs.		
10779PK	#8 (4.20mm) Screw Size 14mm Stem Length 16.70mm Head Size 8.00 x 10.00mm Hole Size White Nylon With Sealer Rocker Moulding Screw Grommets Hyundai #87758-37000	25 Pcs.		
10617PK	#8 (4.20mm) Screw Size 14mm Stem Length 20 x 28mm Head Size 7.50 x 12mm Hole Size Natural Nylon Bumper Screw Grommets Nissan # 71144-SR3-A00	25 Pcs.		
11281PK	#8 (4.20mm) Screw Size 15mm Stem Length 15mm Head Diameter 8mm Hole Size Natural Nylon With Sealer Screw Grommets Honda # 90664-SB3-003	10 Pcs.		

Specialty Nuts

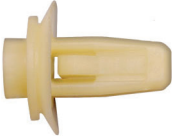



Nuts Nylon

9659PK	#8 (4.20mm) Screw Size 15mm Stem Length 20mm Head Diameter White Nylon Screw Grommets Mazda # GJ6A-58-975	10 Pcs.		
18825PK	4.2-1.41 Screw Size 16mm Stem Length 10.20mm Head Size Black Nylon Roof Lamp Grommets Chrysler # 68224180AC	25 Pcs.		
11028PK	#8 (4.20mm) Screw Size 15mm Stem Length 20mm Head Diameter 10mm Hole Size Natural Nylon With Sealer Rocker Moulding Screw Grommets Nissan # 01281-00711	10 Pcs.		
11202PK	#8 (4.20mm) Screw Size 16mm Stem Length 12mm Head Size 7mm Hole Size Natural Nylon With Sealer Bumper Cover Grommets G.M. # 11561847	25 Pcs.		
10658PK	#8 (4.20mm) Screw Size 16mm Stem Length 12mm Head Diameter 7mm Hole Size Natural Nylon With Sealer Door Panel Screw Grommets Honda # 90370-SG0-003, 91626-SH3-003	15 Pcs.		
12725PK	#8 (4.20mm) Screw Size 16mm Stem Length 12mm Head Size 10mm Hole Size Black Nylon Screw Grommets Mitsubishi # MB029111 Toyota # 90189-04008, 90467-12096, 94841130	15 Pcs.		
10772PK	#8 (4.20mm) Screw Size 16mm Stem Length 17.00 x 25.00mm Head Size 8.00 x 10.00mm Hole Size Yellow Nylon With Sealer Trim Screw Grommets Hyundai #87759-27000	25 Pcs.		
13318PK	#8 (4.20mm) Screw Size 16mm Stem Length 18mm Flange Diameter Natural Nylon Trim Screw Grommets Mercedes # 000-988-86-25	25 Pcs.		
1572PK	#8 (4.20mm) Screw Size 17mm Stem Length 16mm Head Diameter 8mm Hole Size Natural Nylon Screw Grommets Honda # 90661-SC7-0030, 90661-SC7-003 Mazda # H001-50-841, Mitsubishi # MS-480012 Nissan # 01651-00481, 74798-S90000, 01281-00231 Toyota # 90189-06042	25 Pcs.		

5

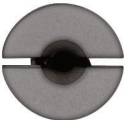
Specialty Nuts

Nuts Nylon

11994PK	#8 (4.20mm) Screw Size 18mm Stem Length 11.50mm Head Size Black Nylon Bumper & Tail Light Screw Grommets Ford # W708580-S300	25 Pcs.		
10552PK	#8 (4.20mm) Screw Size 18mm Stem Length 13.00 x 22.00mm Head Diameter 6.00 x 16.50mm Hole Size Natural Nylon With Sealer Back Glass Moulding & Inter. Trim Ford # W705590-S300, W710459-S300 G.M. # 25649667	15 Pcs.		
10943PK	#8 (4.20mm) Screw Size 18mm Stem Length 16mm Head Diameter 8mm Hole Size Black Nylon Interior Frame Grommets V.W. # 4A0-857-610	25 Pcs.		
10406PK	#8 (4.20mm) Screw Size 18mm Stem Length 16mm Head Diameter 9mm Hole Size Natural Nylon With Sealer Trunk Trim Screw Grommets Mitsubishi # MU480034	15 Pcs.		
10938PK	#8 (4.20mm) Screw Size 18.50mm Stem Length 16mm Head Diameter 8.50mm Hole Size Natural Nylon Screw Grommets V.W. # 321-813-998A	25 Pcs.		
10524PK	#8 (4.20mm) Screw Size 20mm Stem Length 15mm Head Size 8.50mm Hole Size Natural Nylon With Sealer Door Trim Screw Grommets Chrysler # 6507009-AA	25 Pcs.		
10926PK	#8 (4.20mm) Screw Size 20mm Stem Length 15mm Head Diameter 9mm Hole Size Black Nylon Bumper & Fender Screw Grommets V.W. # N908-214-01	15 Pcs.		
12051PK	#8 (4.20mm) Screw Size 20mm Stem Length 16mm Head Diameter Natural Nylon With Sealer Screw Grommets Nissan # 01281-00691	15 Pcs.		
9662PK	#8 (4.20mm) Screw Size 21mm Stem Length 18mm Head Size 8.50mm Hole Size Natural Nylon With Sealer Bumper Screw Grommets Hyundai # 86910-21010	15 Pcs.		



5

Specialty Nuts



Nuts Nylon

2117PK	#8 (4.20mm) Screw Size 23mm Stem Length 10mm Head Size 7mm Hole Size Natural Nylon Screw Grommets Ford # N804765-S	50 Pcs.		
---------------	--	----------------	---	---

Retainers Grommets & Pin



16447PK	1 1/64" (4.50mm) Hole Size 5mm Stem Length 28mm Head Diameter Black Nylon Bumper Cover Grommets G.M. # 15265199	25 Pcs.		
----------------	--	----------------	--	---

Nuts Nylon



9323PK	#10 (4.80mm) Screw Size 7mm Stem Length 13mm Head Diameter 8mm Hole Size Natural Nylon Screw Grommets Mitsubishi # MB383455 Nissan # 01281-00022, 72774-01F00	50 Pcs.		
---------------	--	----------------	---	---

1610PK	#10 (4.80mm) Screw Size 7mm Stem Length 14mm Head Size 9mm Hole Size Black Nylon Screw Grommets Toyota # 90189-06018	25 Pcs.		
---------------	--	----------------	--	--

13324PK	#10 (4.80mm) Screw Size 7mm Stem Length 14.00 x 14.00mm Head Size 9.50 x 8.50mm Hole Size Yellow Nylon Screw Grommets Subaru # 66117-9000, 90930-0007	25 Pcs.		
----------------	---	----------------	---	---

10978PK	#10 (4.80mm) Screw Size 7.30mm Stem Length 17mm Head Size 1.50 x 7.00mm Hole Size Natural Nylon Bumper Grommets Honda # 90107-SX0-003	15 Pcs.		
----------------	---	----------------	---	---



















14992PK	#10 (4.80mm) Screw Size 7.50mm Stem Length 11.50mm Head Size 8.00 x 8.00mm Hole Size Natural Nylon Spalsh Shield Grommets Mazda # 9991-00-501	25 Pcs.		
----------------	---	----------------	---	---

15829PK	#10 (4.80mm) Screw Size 8mm Stem Length 13mm Head Diameter 8mm Hole Size White Nylon License Plate Grommets G.M. # 3783006	50 Pcs.		
----------------	--	----------------	---	---

5

Specialty Nuts



















Nuts Nylon

1614PK	#10 (4.80mm) Screw Size 8mm Stem Length 13mm Head Size 8.50mm Hole Size Natural Nylon Screw Grommets Honda # 75521-611-0000, 91619-SA5-003 Mazda # 9991-00-601 Nissan # 96706-P0105 Toyota # 90189-06010	25 Pcs.		
10771PK	#10 (4.80mm) Screw Size 8mm Stem Length 14.70mm Head Diameter 8.50mm Hole Size Yellow Nylon Interior Trim Grommets Hyundai # 81385-38000	25 Pcs.		
1296PK	#10 (4.80mm) Screw Size 8mm Stem Length 16.50mm Head Size 8.00 x 8.50mm Hole Size Natural Nylon Screw Grommets Honda # 90662-671-0030, 90662-671-003, 90662-SB-003 Mazda # 9991-00-503 Nissan # 68425-H5000, 62698-V7000	25 Pcs.		
15343PK	#10 (4.80mm) Screw Size 8.70mm Stem Length 17.00 x 17.00mm Head Size White Nylon Arm Rest Screw Grommets Subaru # 94079AA000	15 Pcs.		
10549PK	#10 (4.80mm) Screw Size 9.50mm Stem Length 14.00 x 20.00mm Head Size White Nylon Cowl Vent Grommets Chrysler # 4860375-AB	50 Pcs.		
10659PK	#10 (4.80mm) Screw Size 10mm Stem Length 16mm Head Diameter 9mm Hole Size Natural Nylon Screw Grommets Nissan # 01281-00111 Toyota # 90189-06006	25 Pcs.		
12914PK	#10 (4.80mm) Screw Size 10mm Stem Length 16mm Head Size Black Nylon Wheel Well Moulding Screw Grommets Honda # 90107-S10-003	25 Pcs.		
10796PK	#10 (4.80mm) Screw Size 11mm Stem Length 12mm Head Size 9mm Hole Size White Nylon Bumper & Fender Screw Grommets Hyundai # 14913-05010	25 Pcs.		
17945PK	#10 (4.80mm) Screw Size 11mm Stem Length 9.50mm Head Size Natural Nylon Lower Door & Handle Interior Trim Grommets G.M. # 90230846, 94515248	25 Pcs.		

5

Specialty Nuts

Nuts Nylon

1560PK	#10 (4.80mm) Screw Size 11mm Stem Length 12mm Head Size 8.00 x 9.00mm Hole Size Natural Nylon Grille Screw Grommets G.M. # 94841764 Mitsubishi # MS480002, MS480009 Toyota # 90189-05013	50 Pcs.		
17833PK	#10 (4.80mm) Screw Size 11mm Stem Length 20mm Head Diameter 11.50 x 7.50mm Hole Size Black Nylon Radiator Grille Screw Grommets	25 Pcs.		
17908PK	#10 (4.80mm) Screw Size 11mm Stem Length 20mm Head Diameter 11.50 x 7.50mm Hole Size Red Nylon Radiator Grille Screw Grommets Ford # W702438-S300	25 Pcs.		
10777PK	#10 (4.80mm) Screw Size 12mm Stem Length 16mm Head Diameter 8.50mm Hole Size Black Nylon Fender Apron Screw Grommets Hyundai # 86848-22000, 86848-C8000	25 Pcs.		
12585PK	#10 (4.80mm) Screw Size 12.50mm Stem Length 12mm Head Diameter Black Nylon Screw Grommets Audi # 867-809-966 V.W. # 811-807-557-C	25 Pcs.		
10620PK	#10 (4.80mm) Screw Size 13mm Stem Length 16mm Head Diameter 8.50mm Hole Size Natural Nylon With Sealer Body Moulding Screw Grommets Nissan # 01281-00601	15 Pcs.		
10981PK	#10 (4.80mm) Screw Size 14mm Stem Length 14mm Head Size 8.50mm Hole Size Black Nylon Rear Bumper Screw Grommets Honda # 90682-SDA-A01	15 Pcs.		
10426PK	#10 (4.80mm) Screw Size 14mm Stem Length 25.00 x 26.00mm Head Size 9.50 x 23.00mm Hole Size Black Nylon Headlight To Grille Spacer Bracket Grommets Honda # 91635-SM4-003	10 Pcs.		
13322PK	#10 (4.80mm) Screw Size 15mm Stem Length 12mm Head Diameter 6.50 x 8.00mm Hole Size Black Nylon Screw Grommets V.W. # 6N0-809-966A	25 Pcs.		

5

Specialty Nuts

Nuts Nylon



















11156PK	#10 (4.80mm) Screw Size 16mm Stem Length 20mm Flange Diameter 8.50mm Hole Size White Nylon With Sealer Bumper Grommets Nissan # 63846-5V000	25 Pcs.		
15147PK	#10 (4.80mm) Screw Size 17mm Stem Length 12.00 x 19.00mm Head Size 8.00 x 15.00mm Hole Size White Nylon Screw Grommets Honda # 90683-693-0000 Nissan # 78856-R4301	25 Pcs.		
1576PK	#10 (4.80mm) Screw Size 17mm Stem Length 18mm Head Diameter 8.50mm Hole Size Natural Nylon Screw Grommets Mitsubishi # MB-098145 Nissan # 01281-00023, 01281-00231 Toyota # 90189-06001, 96706-U0100	25 Pcs.		
11036PK	#10 (4.80mm) Screw Size 17.50mm Stem Length 16mm Head Diameter 10mm Hole Size Natural Nylon Front Bumper Grommets Nissan # 01281-01081	15 Pcs.		
12611PK	#10 (4.80mm) Screw Size 18mm Stem Length 9.50 x 8.50mm Hole Size White Nylon With Sealer Bumper Cover Screw Nuts Hyundai # 86625-3S000	25 Pcs.		
10942PK	#10 (4.80mm) Screw Size 20mm Stem Length 16mm Head Diameter 8mm Hole Size Black Nylon Door Panel Screw Grommets V.W. # 357-827-998	15 Pcs.		
11229PK	#10 (4.80mm) Screw Size 24mm Stem Length 16mm Head Diameter 10mm Hole Size White Nylon With Sealer Front Bumper Screw Grommets Ford # W708319-S300	25 Pcs.		

Retainers Grommets

10977PK	5-.80mm Screw Size 8mm Stem Length 13mm Head Size 8mm Hole Size Natural Nylon Headlight Adjusting Grommets Honda # 90676-SA7-003, 90682-SB0-003	25 Pcs.		
----------------	---	----------------	--	--

Specialty Nuts

Nuts Nylon

10775PK	#12 (5.50mm) Screw Size 8.50mm Stem Length 13mm Head Size 9mm Hole Size White Nylon Rocker Moulding Screw Grommets Hyundai # 87756-35000	25 Pcs.		
18102PK	#12 (5.50mm) Screw Size 9mm Stem Length 10mm Top Head Size Yellow Nylon Front & Rear Bumper Screw Grommets Nissan # 85099-1MA0A	25 Pcs.		
10745PK	#12 (5.50-6mm) Screw Size 9mm Stem Length 17.00 x 30.00mm Head Size Black Nylon Front Bumper Screw Grommets Toyota # 52535-50060, 52535-0E010	5 Pcs.		
10794PK	#12 (5.50mm) Screw Size 10mm Stem Length 14.00 x 16.00mm Head Size 9.00 x 11.00mm Hole Size White Nylon Front Bumper Screw Grommets Toyota # 90189-06193, 90189-06237	25 Pcs.		
12073PK	#12 (5.50mm) Screw Size 10mm Stem Length 17mm Head Diameter 9mm Square Hole Size Black Nylon Rocker & Floor Screw Grommets Toyota # 90189-06211	25 Pcs.		
9503PK	#12 (5.50mm) Screw Size 11mm Stem Length 15.60mm Flange Size 9mm Hole Size Black Nylon License Plate Nuts Chrysler # 6032516	25 Pcs.		
10551PK	#12 (5.50mm) Screw Size 9/16" Stem Length 5/8 x 3/4" Head Size 11/32 x 1/2" Hole Size Natural Nylon Door Handle Screw Grommets G.M. # 11517873	15 Pcs.		
15839PK	#12 (5.50mm) Screw Size 15mm Stem Length 16mm Head Diameter 10mm Hole Size Natural Nylon Back Panel Attachment Grommets Ford # W700566-S300	25 Pcs.		
16470PK	#12 (5.50mm) Screw Size 17mm Stem Length 18mm Head Diameter 9mm Hole Size Natural Nylon With Sealer Rear Door Screw Grommets Hyundai # 86910-22000 Toyota # 90189-06029, 90189-06084, 90189-06116	10 Pcs.		

5

Specialty Nuts



















Nuts Nylon

18164PK	#12 (5.50mm) Screw Size 17mm Stem Length 20mm Flange Diameter 9mm Hole Size Black Nylon Fender Liner Screw Grommets Toyota # 90189-06236	25 Pcs.		
15812PK	#12 (5.50mm) Screw Size 17mm Stem Length 20mm Head Diameter 9mm Square Hole Size Black Nylon Screw Grommets Toyota # 90189-A0002	25 Pcs.		
10988PK	#12 (5.50mm) Screw Size 18mm Stem Length 16mm Head Diameter 9mm Hole Size Black Nylon Fender Liner Screw Grommets Toyota # 90189-06214	15 Pcs.		
13323PK	#12 (5.50mm) Screw Size 18mm Stem Length 20mm Head Diameter White Nylon With Sealer Screw Grommets Subaru # 91084AA010	15 Pcs.		
11389PK	#12 (5.50mm) Screw Size 18mm Stem Length 20mm Head Diameter 9mm Hole Size Black Nylon Fender & Hood Screw Grommets Toyota # 90189-06065	15 Pcs.		
9912PK	#12 (5.50mm) Screw Size 19mm Stem Length 16mm Head Diameter 8mm Square Hole Size Black Nylon Front & Rear Wheel Fender Liner Screw Grommets G.M # 94854203 Toyota # 90189-06028	15 Pcs.		
9136PK	#12 (5.50mm) Screw Size 13/16" Stem Length 1/2" Head Size 3/8" Square Hole Natural Nylon Windshield Washer Reservoir Mounting Screw Grommets Ford # F5RZ-17K657-A	25 Pcs.		
9913PK	#12 (5.50mm) Screw Size 22mm Stem Length 20mm Head Diameter 8mm Square Hole Size Black Nylon Front & Rear Wheel Fender Liner Screw Grommets Toyota # 90189-06157	15 Pcs.		

5

Specialty Nuts















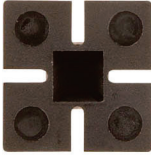

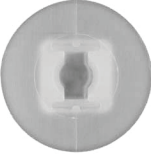
Nuts Nylon

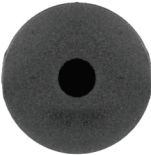
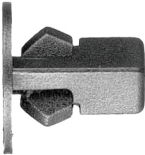
9481PK	#12 (5.50mm) Screw Size 24mm Stem Length 22.00 x 18.00mm Head Size White Nylon With Sealer Front Bumper Screw Grommets Lexus # 52197-30040	15 Pcs.		
18831PK	6-1.00mm Thread Size 25/64" (10mm) Hole Size 18mm Flange Diameter 10mm Height Black Nylon Wheel Apron Thumb Drive Nuts Toyota # 90467-06169	25 Pcs.		
9101PK	#14 (6.30mm) Screw Size 8mm Stem Length 13.00 x 15.00mm Head Size 8.50 x 10.50mm Hole Size Natural Nylon Screw Grommets Honda # 90656-671-6310M1	50 Pcs.		
9494PK	#14 (6.30mm) Screw Size 5/16" Stem Length 5/8 x 3/4" Head Size 3/8" Hole Size Natural Nylon License Plate Nuts Ford # 380707-S	50 Pcs.		
9872PK	#14 (6.30mm) Screw Size 8mm Stem Length 14.30mm Head Diameter 8.50mm Hole Size Natural Nylon License Plate Screw Grommets G.M. # 380370	50 Pcs.		
17927PK	#14 (6.30mm) Screw Size 8mm Stem Length 16mm Head Size Black Nylon With Sealer Bumper, License Plate & Tail Light Screw Grommets G.M. # 25832258	10 Pcs.		
1228PK	#14 (6.30mm) Screw Size 5/16" Stem Length 5/8" Head Size 13/32" Hole Size White Plastic License Plate Nuts Chrysler # 6023925 G.M. # 3907444	50 Pcs.		
10461PK	#14 (6.30mm) Screw Size 8mm Stem Length 16mm Head Size 9.50 x 10.00mm Hole Size Black Nylon With Sealer License Plate Grommets Ford # N811478-S100	15 Pcs.		
9678PK	#14 (6.30mm) Screw Size 10mm Stem Length 12.00 x 16.00mm Head Size Gray Nylon Wheel Well Opening Screw Grommets Use With # 9679 Nissan # 76848-JG00A	15 Pcs.		

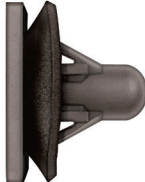
5

Specialty Nuts















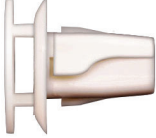

Nuts Nylon

9679PK	8 x 17mm Head Size 12mm Stem Length Yellow Nylon Wheel Well Opening Moulding Clips Use With # 9678 Nissan # 76847-JG00A	25 Pcs.		
12664PK	#14 (6.30mm) Screw Size 11mm Stem Length 15mm Head Diameter 9.50mm Hole Size Natural Nylon Screw Grommets G.M. # 4755299	50 Pcs.		
10525PK	#14 (6.30mm) Screw Size 14mm Stem Length 20mm Head Size 8mm Hole Size Black Nylon License Plate Grommets G.M. # 22546934	50 Pcs.		
11020PK	#14 (6.30mm) Screw Size 16mm Stem Length 20mm Head Diameter 10mm Hole Size Natural Nylon With Sealer Rocker Panel Screw Grommets Nissan # 01281-00331	25 Pcs.		
1605PK	#14 (6.30mm) Screw Size 17mm Stem Length 20mm Head Diameter 8mm Square Hole Size Black Nylon Screw Grommets Toyota # 90189-06013, 96706-W100	25 Pcs.		
10550PK	#14 (6.30mm) Screw Size 17mm Stem Length 24mm Head Size 15mm Hole Size Black Nylon With Sealer Light Housing Screw Grommets G.M. # 15745990, 15289020, 11609535	15 Pcs.		
13437PK	#14 (6.30mm) Screw Size 19mm Stem Length 16.00 x 18.00mm Head Size Black Nylon Bumper Side Bracket Screw Grommets Toyota # 52197-22020	15 Pcs.		
10119PK	#14 (6.30mm) Screw Size 3/8" Hole Size Natural Nylon License Plate Screw Grommets Chrysler # 6027958	10 Pcs.		
11391PK	#14 (6.30mm) Screw Size 23mm Stem Length 15.00 x 18.00mm Head Size White Nylon With Sealer Rear Bumper Screw Grommets G.M. # 25704358	10 Pcs.		

5

Specialty Nuts

Nuts Nylon

1608PK	#14 (6.30-1.81mm) Screw Size 16mm Stem Length 18mm Head Diameter 8mm Hole Size White Nylon Screw Grommets Toyota # 90189-06005	50 Pcs.		
15330PK	8mm Square Hole Size 10mm Stem Length 11.00 x 11.00mm Head Size Blue Nylon Screw Grommets Subaru # 62731-FA010	25 Pcs.		
13440PK	#14 (6.30-1.81mm) Screw Size 16mm Stem Length 15.00 x 19.00mm Head Size Brown Nylon With Sealer Screw Grommets Nissan # 26557-2U001	15 Pcs.		
17067PK	5/16" (8mm) Hole Size 14mm Stem Length 18mm Head Diameter Natural Nylon With Sealer Tail Light Grommets Mazda # GA7B-51-146	25 Pcs.		
9079PK	23/64" (9mm) Hole Size 15mm Stem Length 18mm Head Diameter White Nylon Front Fender Screw Grommets Toyota # 90189-06114	15 Pcs.		
17086PK	23/64" (9mm) Square Hole Size 17mm Stem Length 18mm Flange Size Yellow Nylon Bumper Cover W/Sealer Screw Grommets Toyota # 52188-33040	25 Pcs.		
16444PK	3/8" (9.40mm) Square Hole Size 12.50mm Stem Length 22mm Head Diameter Natural Nylon Front & Rear Door Panel Screw Grommets Ford # W711501-S300	25 Pcs.		
15341PK	25/64" (10mm) Hole Size 19.50mm Stem Length 25.00 x 33.00mm Head Size Black Nylon With Sealer Bumper Cover Grommets Subaru # 99011FC000NN	15 Pcs.		
10055PK	15/32" (12mm) Hole Size 12mm Stem Length 16mm Head Size Black Nylon Tail Light Grommets Chrysler # 6504072	25 Pcs.		

5

Specialty Nuts

Nuts Nylon

16308PK	15/64" (6.00mm) Screw Size 23mm Stem Length 15mm Square Head 10mm Square Hole Size Gray Nylon With Sealer License Plate Grommets Ford # W714172-S300	15 Pcs.		
13248PK	33/64" (13mm) Hole Size 21mm Stem Length 24mm Head Diameter Black Nylon Bumper Cover Grommet Mitsubishi # MB271999	10 Pcs.		
13299PK	5mm Stud Diameter 10mm Hex Size 16mm Flange Diameter Black Nylon Flange Nuts BMW # 16-13-1-176-747 Mercedes # 003-990-02-51	25 Pcs.		
12062PK	11mm Head Size 9mm Stem Length 8mm Hole Size White Nylon Front & Rear Bumper Cover Grommets Kia # 86699-2D000	25 Pcs.		
13083PK	16mm Head Diameter 12mm Stem Length 8mm Hole Size Black Nylon Screw Grommets Nissan # 76881-JG00A	15 Pcs.		
11397PK	18mm Top Head Diameter 9.50mm Stem Length 10mm Hole Size Natural Nylon Bumper Grommets Honda # 91509-SM4-000	10 Pcs.		
10999PK	18.00 x 20.00mm Head Size 19mm Stem Length 8.00 x 11.00mm Hole Size White Nylon Bumper Grommets Honda # 90106-SW3-003	10 Pcs.		
12075PK	25 x 30mm Head Size 15mm Stem Length 35mm Overall Length Black Nylon With Sealer Bumper Cover Grommet Kia # 86591-25000	5 Pcs.		
10971PK	17mm Overall Height 30mm Overall Length Black Nylon Bumper Filler Clips Toyota # 53935-35020	10 Pcs.		



5



Specialty Nuts

Nuts Nylon



11129PK	22mm Overall Length Natural Nylon Front Bumper Grommets Nissan # 01281-01321	50 Pcs.		
----------------	---	----------------	---	---



Retainers Grommets

15716PK	9/32" (7mm) Hole Size 5mm Stem Length 9mm Head Diameter White Nylon Moulding Grommet Mercedes # 000-987-10-81	50 Pcs.		
----------------	--	----------------	---	---

13333PK	9/32" (7mm) Stud Size 16mm Stem Length 16mm Head Diameter 8.50mm Hole Size Natural Nylon Tubular Nuts BMW # 51-44-7-780-135 Mercedes # 108-988-00-27	25 Pcs.		
----------------	---	----------------	---	---



16456PK	5/16" (8mm) Hole Size 13mm Stem Length 13mm Head Diameter White Nylon With Sealer Cowl & Wheelhouse Screw Grommets Honda # 90601-S30-003	25 Pcs.		
----------------	--	----------------	---	---



16455PK	5/16" (8mm) Hole Size 14mm Stem Length 18mm Head Diameter Blue Nylon With Sealer Tail Light Grommets Honda # 91626-TA0-A01	25 Pcs.		
----------------	---	----------------	--	--

18884PK	21/64" (8.50mm) Hole Size 14mm Stem Length 15mm x 19mm Head Size White Nylon Tail Light Grommets Subaru # 909220013	15 Pcs.		
----------------	--	----------------	---	---

10498PK	8.75 x 15.75mm Hole Size 17.50mm Stem Length 13.00 x 20.00mm Head Size Blue Nylon With Sealer Headlight Screw Grommets G.M. # 11561382, 11610198	10 Pcs.		
----------------	---	----------------	---	---

10973PK	23/64" (9mm) Hole Size 6mm Stem Length 13mm Head Diameter Black Nylon Inserts Grommets V.W. # 357-853-586D	25 Pcs.		
----------------	---	----------------	---	---



1404PK	23/64" (9mm) Hole Size 6.70mm Stem Length 10.50mm Head Diameter 4.50mm Pin Diameter Red Nylon Moulding Grommets Mercedes # 000-988-15-81	50 Pcs.		
---------------	--	----------------	---	---

12477PK	23/64" (9mm) Hole Size 12mm Stem Length 11.50mm Head Diameter White Nylon Moulding Insert Grommets Mercedes # 001-988-20-81, 001-988-76-81	25 Pcs.		
----------------	---	----------------	---	---



5

Specialty Nuts

Nuts Nylon

12626PK	23/64" (9mm) Hole Size 14mm Stem Length 4.50mm Inside Diameter Red Nylon Tubular Nuts Mercedes # 001-988-20-81	50 Pcs.		
----------------	---	----------------	--	---

Nuts Miscellaneous



18099PK	23/64" (9mm) Hole Size 9mm Overall Height 30mm Head Diameter Gray Nylon Sound Insulation Grommets BMW # 51-48-8-126-849	25 Pcs.		
----------------	--	----------------	--	---

5

Retainers Grommets



18261PK	9.80mm Hole Size 4.80mm Stud Size 17mm Head Diameter Black Rubber Tail Lamp Grommet G.M. # 11571225	10 Pcs.		
----------------	--	----------------	--	---



Nuts Push On Type Non-Threaded Stud



16450PK	5mm Stud 25/64" (10mm) Hole Size 8mm Stem Length 30mm Head Diameter Black Nylon Wheel House Liner Retainers G.M. # 94530387	25 Pcs.		
----------------	---	----------------	---	--

Retainers Grommets

12024PK	10.00 x 11.00mm Hole Size 10mm Stem Length 13.00 x 17.00mm Head Size Black Nylon Tail Light Grommets Ford # W711079-S300	25 Pcs.		
----------------	---	----------------	--	---





9355PK	25/64" (10mm) Hole Size 9mm Stem Length 13mm Head Diameter Black Nylon Grille & Side Marker Light Screw Grommets Ford # N807994-S, N811169S, W704740-S300, W705550S300	50 Pcs.		
---------------	--	----------------	--	---

10781PK	25/64" (10mm) Hole Size 8mm Stem Length 15mm Head Diameter Natural Nylon Headlight Assembly Grommets Hyundai # XG300/350 Kia # 92351-37000	25 Pcs.		
----------------	--	----------------	--	---

15816PK	25/64" (10mm) Hole Size 15mm Stem Length 18mm Head Diameter White Nylon With Sealer Tail Light Grommets G.M. # 22884291	10 Pcs.		
----------------	--	----------------	--	---



Specialty Nuts



Retainers Grommets

16374PK	7/16" (11mm) Hole Size 14mm Stem Length 16mm Flange Diameter Natural Nylon With Sealer Screw Grommets Honda # 90601-SNV-P01	25 Pcs.		
16309PK	25/64" (10mm) Hole Size 17.50mm Overall Length 19mm Head Diameter Orange Nylon With Sealer Tail Lamp Grommets G.M. # 84221533	10 Pcs.		
13368PK	7/16" (11mm) Hole Size 16mm Stem Length 16mm Head Diameter White Nylon Fog Light Grommets G.M. # 11570830	15 Pcs.		
9712PK	7/16" (11mm) Hole Size 9mm Stem Length 13mm Head Diameter White Nylon Park & Turn Signal Grommets Ford # N811169-S, W705550-S300 G.M. # 10423331 Toyota # 90075-10801, 90189-06111	50 Pcs.		
10526PK	7/16" (11mm) Hole Size 17mm Stem Length 15mm Head Diameter Black Nylon With Sealer Tail Light Grommets G.M. # 11561655, 11609862, 11610705	5 Pcs.		
9418PK	11.50 x 15.50mm Hole Size 26mm Length 22mm Width Black Nylon Grille Grommet Retainers Nissan # 62380-U7400	10 Pcs.		
15017PK	11.50 x 18.00mm Hole Size 10mm Stem Length 17.00 x 23.00mm Head Size Black Nylon Headlight Assembly Grommets Nissan # 76848-8J010	10 Pcs.		
11127PK	12mm Hole Size 11mm Stem Length 19mm Head Diameter Black Nylon Tail Light Assembly Grommets Chrysler # 68084593-AA	25 Pcs.		
10541PK	14.00 x 26.00mm Hole Size 20.00 x 31.00mm Head Size Receives 10mm Ball Stud Black Nylon Tail Light Grommets Chrysler # 55156879-AB	25 Pcs.		

Specialty Nuts

Retainers Grommets



11162PK	19/32" (15mm) Hole Size 21mm Stem Length 24mm Head Diameter .90mm Thick Panel Black Nylon With Sealer Tail Light Grommets G.M. # 11561987	15 Pcs.		
----------------	---	----------------	--	---

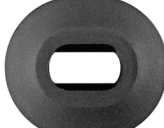
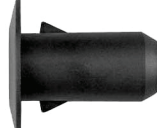

10554PK	9.00 x 16.00mm Hole Size 17mm Stem Length 13.00 x 20.00mm Head Size Black Nylon Rear Light Housing Screw Grommets Chrysler # 5113360-AA G.M. # 15284612, 11609536, 15745991	15 Pcs.		
----------------	--	----------------	--	---

5



11126PK	9.50 x 21.50mm Hole Size 18mm Stem Length 18.50 x 21.50mm Head Size Black Nylon Headlight & Tail Light Grommets Ford # F50Y-14603-A	25 Pcs.		
----------------	--	----------------	--	---



Retainers Grommets & Pin

12093PK	9/32" (7mm) Hole Size 7mm Stem Length 14mm Flange Diameter 3mm Pin Diameter Natural Nylon Cowl Grommets Use With #12094 Subaru # 91486-KJ000	25 Pcs.		
----------------	---	----------------	--	---

16387PK	9/32" (7mm) Hole Size 7.30mm Stem Length 16mm Head Diameter Gray Nylon Cowl Grille Grommets Use With Disco # 12094 Subaru # 91486FL020	25 Pcs.		
----------------	--	----------------	--	---

12094PK	3mm Pin Diameter 13mm Stem Length 16.00 x 18.00mm Head Size Black Nylon Cowl Retainers Use With #12093 or 16387 Subaru # 91486-KJ010	25 Pcs.		
----------------	--	----------------	--	---

10959PK	5/16" (8mm) Hole Size 11mm Stem Length 13.20mm Head Diameter 6mm Pin Diameter Natural Nylon Door Trim Panel Grommets Use With #10958 V.W. # 3B0-867-334	50 Pcs.		
----------------	--	----------------	--	---

10958PK	6mm Pin Diameter 12.50mm Top Head Diameter 16mm Stem Length Natural Nylon Door Trim Panel Retainers Use With #10959 V.W. # 3B0-867-333	25 Pcs.		
----------------	--	----------------	--	---

Specialty Nuts

Retainers Nylon Grommets & Pin

12376PK	23/64" (9mm) Hole Size 16mm Stem Length 18mm Head Diameter White Nylon Cowl Vent Grommets Use With # 12375 Toyota # 90467-10152	10 Pcs.		
12375PK	23/64" (9mm) Pin Size 17mm Stem Length 16mm Head Diameter Black Nylon Cowl Vent Pin Retainers Use With # 12376 Toyota # 90467-07126	10 Pcs.		
10467PK	23/64" (9mm) Hole Size 12mm Stem Length 19mm Head Diameter 3mm Pin Diameter White Nylon Door Panel Grommets Use With #10466 Chrysler # 6506655AA	25 Pcs.		
11169PK	23/64" (9mm) Hole Size 12mm Stem Length 19mm Head Diameter 3mm Pin Diameter Green Nylon Door Panel Grommets Use With #10466 Chrysler # 4784018-AA	25 Pcs.		
10466PK	3mm Pin Diameter 20mm Stem Length 13mm Top Head Diameter White Nylon Door Trim Panel Pin Retainers Use With #10467 & #11169	25 Pcs.		
18145PK	3/8" (9.50mm) Hole Size 21mm Stem Length Natural Rubber Rear Bumper Cover Grommets Use With # 17832	25 Pcs.		
18255PK	3/8" (9.50mm) Hole Size 21mm Stem Length Black Rubber Rear Bumper Cover Grommets Use With # 17832 Ford # W708045-S300	25 Pcs.		
17832PK	9/32" (7mm) Hole Size 25mm Stem Length 21mm Head Diameter Black Nylon Rear Bumper Cover Retainers Use With # 18145 & 18255 Ford # W708035-S300	25 Pcs.		
10618PK	8.00 x 9.00mm Hole Size 13mm Stem Length 13mm Head Size 4.10mm Pin Diameter White Nylon With Sealer Cowl Vent Screw Grommets Use With #10678 Nissan # 80874-0P00	15 Pcs.		

Specialty Nuts



Retainers Nylon Grommets & Pin



10678PK	4.10mm Pin Diameter 15mm Stem Length 10mm Head Diameter Black Nylon Cowl Screen Pin Retainers Use With #10618 Nissan # 66820-88E00	25 Pcs.		
13255PK	6mm Stud Size 20mm Overall Width 16mm Overall Height Black Nylon Skid Shield Grommets Use With # 12589 V.W. # 4A0805163	25 Pcs.		
12589PK	6mm Stud Size 22mm Stem Length 25mm Head Diameter Black Nylon Skid Plate Screws Use With # 13255 V.W. # 4A0-805-121A	25 Pcs.		
11189PK	9.50 x 13.50mm Hole Size 18mm Stem Length 17.50 x 21.50mm Head Size 5mm Pin Diameter Black Nylon Fascia Grommets Use With #11190 G.M. # 22603044	15 Pcs.		
11190PK	5mm Pin Diameter 19.70mm Pin Length 3.30mm Panel Range Black Nylon Front Bumper Fascia Hinged Pin Retainers Use With #11189 G.M. 22615352, 11588782, 22603043	15 Pcs.		
11984PK	5.80mm Stud Size 13mm Hex Size 25mm Washer Diameter Black Nylon Grille Retainer Nuts Use With # 11983 Camaro 2010 Cadillac SRS & SRX G.M. # 11610748	25 Pcs.		
11983PK	5.80mm Stem Diameter 25.50mm Stem Length 25mm Head Diameter Black Nylon Slotted Grille Retainers Use With # 11984 Camaro 2010 Cadillac SRS & SRX G.M. # 11610747	25 Pcs.		
16446PK	28mm Top Diameter 17.50mm Bottom Diameter 23mm Overall Height Black Nylon Body Mount Cushion Sleeves G.M. # 15924986	25 Pcs.		

5

Specialty Nuts

Retainers Nylon Grommets & Pin



18230PK	13.50 x 7.60mm Hole Size 16mm Stem Length 14.00 x 22.00mm Head Size Dark Gray Engine Cover Grommets Honda # 91548-TZ5-A02	25 Pcs.		
----------------	--	----------------	---	---

18229PK	17mm Stem Length 22mm Overall Length 13mm Top Head Diameter Black Nylon Engine Cover Retainers Honda # 91547-TZ5-A02	50 Pcs.		
----------------	---	----------------	---	---



Nuts Metal Miscellaneous

12273PK	#6 (3.50mm) Screw Size 10mm Width 18mm Overall Height Zinc Finish Bumper & Grille Fasteners Chrysler # 4806226-AA, 68004187-AA Ford # W710754-S439 G.M. # 11562364	15 Pcs.		
----------------	---	----------------	---	---

9199PK	#8 (4.20mm) Screw Size Zinc Finish Radiator Grille Nuts Ford # N802865-S100 G.M. # 15686142, 11561448	25 Pcs.		
---------------	---	----------------	---	---

11258PK	#8 (4.20mm) Screw Size 8.65mm Hole Size Zinc Finish Fender Bracket Push In Nuts G.M. # 11518531, 11609952	15 Pcs.		
----------------	---	----------------	--	--

12983PK	#8 (4.20mm) Screw Size 6.00 x 16.00mm Head Size 7mm Overall Height Silver Finish Front Bumper Nuts G.M. # 11609952	25 Pcs.		
----------------	---	----------------	---	---

11032PK	#8 (4.20mm) Screw Size .70 - 2.30mm Panel Range 8.70mm Hole Size Blue Finish Mid Panel Nuts Chrysler # 6509432AA Ford # W716529-S900 G.M. # 1570654	25 Pcs.		
----------------	--	----------------	---	---





















10733PK	#8 (4.20mm) Screw Size .70 - 1.50mm Panel Range 8.70mm Hole Size Gray Finish With Sealer Tail Light Quarter Panel Nuts Ford # W714171-S439 G.M. # 11569711	25 Pcs.		
----------------	--	----------------	---	---

18096PK	#8 (4.20mm) Screw Size 11.70mm Width 16.50mm Length Gray Finish With Sealer Specialty Nuts Ford # W713617-S439	15 Pcs.		
----------------	---	----------------	---	---

5

Specialty Nuts







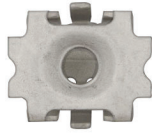

Nuts Metal Miscellaneous

11034PK	#8 (4.20mm) Screw Size 9.00 x 11.00mm Hole Size Black Finish Dash Panel Nuts Ford # N803685S G.M. # 14083173, 17997722, 17988488	25 Pcs.		
17071PK	#8 (4.20mm) Screw Size 10.50 x 12mm Head Size 11mm Stem Length Zinc Finish Radiator Grille Panel Nuts Chrysler # 6510197AA	25 Pcs.		
15983PK	#8 (4.80mm) Screw Size 7mm Stem Length 14 x 23mm Head Size Zinc Organic Front & Rear Bumper Specialty Nuts With Patisol Pad Ford # W715197-S439	10 Pcs.		
15864PK	#8 (4.20-1.41mm) Screw Size 1.40 - 5mm Panel Range 10.90 x 13.00mm Hole Size Green Metallic Finish Bracket Retainer Nuts G.M. # 11548673	15 Pcs.		
15691PK	#8 (4.20-1.41mm) Screw Size Zinc Organic Center Console Door, Front Lights, Grille, Lift Gate Nuts With Silicone Pad G.M. # 11610157	10 Pcs.		
16065PK	#8 (4.20mm) Screw Size .50 - 1.00mm Panel Range 8.55mm Square Hole Size Green Finish W/Silicone Pad Door Panel & Bumper Nuts G.M. # 11546868	15 Pcs.		
10143PK	17/32" (13.50mm) Hole Size 11mm Overall Length Zinc Finish Headlamp Assembly Nuts G.M. # 11570015	15 Pcs.		
16314PK	6-1.00 Screw Size 9/16" (14mm) Square Hole 16.25mm Overall Length Black Finish Bumper, Door Glass & Grille Nuts Chrysler # 6505223AA	10 Pcs.		
18265PK	6-1.00mm Screw Size 10mm Stem length 15mm Square Hole Size 14.50 x 21.00mm Head Size Magni-554 Finish Door & Fender Nuts Chrysler # 6506955AA	10 Pcs.		
18094PK	6-1.00 Screw Size .70-3.80mm Panel Range 9.25 x 13.75mm Hole Size Zinc Finish Rear Bumper Bracket Nuts G.M. # 11547582	25 Pcs.		

5

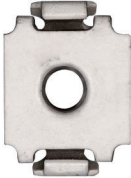



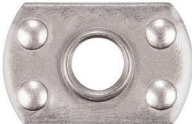



Specialty Nuts

Nuts Metal Miscellaneous

13423PK	6-1.00 Screw Size 11mm Overall Height Zinc Organic Radiator Grille & Front End Panel Nuts G.M. # 11518937	10 Pcs.		
15902PK	6-1.00mm Screw Size 12mm Overall Height Organic Zinc Finish Front Fender Panel Nuts G.M. # 11610544	10 Pcs.		
9597PK	6-1.00mm Screw Size Zinc Organic License Plate Nuts G.M. # 15707256	10 Pcs.		
12849PK	6-1.00mm Thread Size Black Nylon Metal Insert Threaded Hood Adjustment Nuts Ford 1989 - On	10 Pcs.		
9709PK	5/16"-18 Thread Size Plain Finish Slab Weld Nuts	25 Pcs.		









5

Nutserts Hex Type Automotive

12439PK	5-.80mm Thread Size 10mm Hex Size 10mm Flange Diameter .70 - 1.50mm Grip Range Silver and Wax Finish Hex Type Steel Nutserts Chrysler # 6503812, 6504601	15 Pcs.		
12444PK	6-1.00mm Thread Size 8mm Hex Size 12mm Flange Diameter .65 - 2mm Grip Range Zinc Finish W/Sealer Hex Type Steel Nutserts Ford # N803763-S100 G.M. # 15685099, 11518684	15 Pcs.		
12443PK	6-1.00mm Thread Size 9.50mm Hex Size 13mm Flange Diameter .50 - 4.20mm Grip Range Yellow Zinc W/Sealer Hex Type Steel Nutserts Ford # W706172-S309, W708384-S309	15 Pcs.		
12440PK	6-1.00mm Thread Size 9.50mm Hex Size 13mm Flange Diameter .70 - 4mm Grip Range Front Core Support Zinc Hex Type Steel Nutserts G.M. # 11519952	15 Pcs.		

Specialty Nuts

Nutserts Hex Type Automotive

12445PK	6-1.00mm Thread Size 9.50mm Hex Size 17mm Flange Diameter .70 - 3.20mm Grip Range Zinc Finish Hex Type Steel Nutserts Chrysler # 6506104AA	10 Pcs.		
12446PK	6-1.00mm Thread Size 9.50mm Hex Size 17mm Flange Diameter .70 - 3.17mm Grip Range Zinc Finish Hex Type Steel Nutserts Chrysler # 6509106-AA	15 Pcs.		
12441PK	8-1.25mm Thread Size 12.50mm Hex Size 17mm Flange Diameter .70 - 4mm Grip Range Zinc Finish Hex Type Steel Nutserts G.M. # 11519960	15 Pcs.		
11406PK	8-1.25mm Thread Size 12.70mm Hex Size 22mm Flange Diameter .70 - 3.80mm Grip Range Zinc Finish Hex Type Steel Nutserts Ford # W708513-S437	15 Pcs.		

Nutserts Thin Sheet

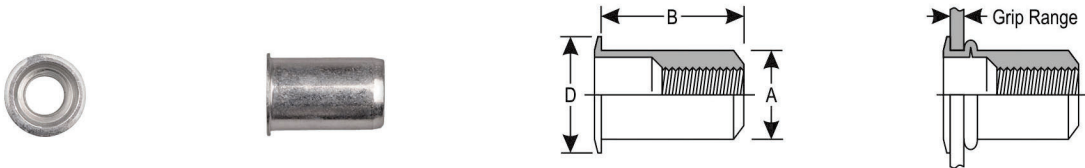

Part #	Thread Size	Grip Range	A	B	D	Drill Size	Qty.
13130PK	6-32	.020 - .080"	.249"	.385"	.295"	1/4"	50 Pcs.
13131PK	8-32	.020 - .080"	.249"	.385"	.295"	1/4"	50 Pcs.
13132PK	10-24	.020 - .130"	.280"	.440"	.320"	9/32"	50 Pcs.
13133PK	10-32	.020 - .130"	.280"	.440"	.320"	9/32"	50 Pcs.
13134PK	1/4-20	.030 - .165"	.347"	.580"	.425"	3/8"	25 Pcs.
13136PK	5/16-18	.030 - .165"	.499"	.690"	.560"	1/2"	25 Pcs.
13138PK	3/8-16	.040 - .200"	.499"	.690"	.560"	1/2"	15 Pcs.
13140PK	4-.70mm	.50 - 2.00mm	6.32mm	9.78mm	7.49mm	6.40mm	50 Pcs.
13141PK	5-.80mm	.50 - 3.30mm	7.11mm	11.18mm	8.13mm	7.20mm	50 Pcs.
13142PK	6-1.00mm	.75 - 4.20mm	9.50mm	14.73mm	10.80mm	9.60mm	25 Pcs.
13143PK	8-1.25mm	1.02 - 5.10mm	12.67mm	17.53mm	14.22mm	12.70mm	25 Pcs.
13144PK	10-1.50mm	1.02-5.10mm	12.67mm	17.53mm	14.22mm	12.70mm	15 Pcs.

Specialty Nuts

Nutserts Round Type

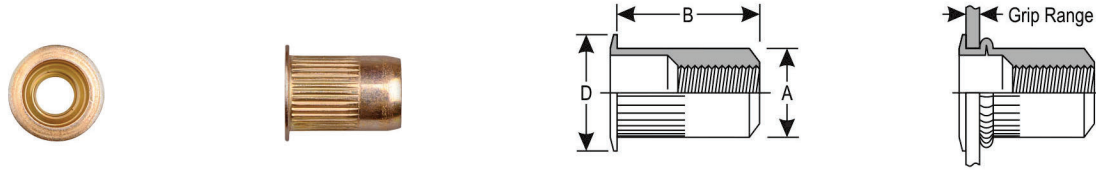

Part #	Thread Size	Grip Range	A	B	D	Drill Size	Qty.
12694PK	6-32	.020-.080"	.265"	.420"	.390"	17/64"	25 Pcs.
12696PK	8-32	.020-.080"	.265"	.420"	.390"	17/64"	25 Pcs.
12698PK	10-24	.020-.130"	.296"	.475"	.415"	19/64"	25 Pcs.
12699PK	10-32	.020-.130"	.296"	.475"	.415"	19/64"	25 Pcs.
12700PK	1/4-20	.027-.165"	.390"	.580"	.500"	25/64"	25 Pcs.
12702PK	5/16-18	.027-.150"	.530"	.690"	.685"	17/32"	10 Pcs.
12704PK	3/8-16	.027-.150"	.530"	.690"	.685"	17/32"	10 Pcs.
12706PK	1/2-13	.063-.200"	.685"	1.150"	.865"	11/16"	5 Pcs.
13411PK	3-50mm	.50-2.00mm	4.90mm	9.02mm	7.85mm	5mm	25 Pcs.
12674PK	4-.70mm	.50-2.00mm	6.73mm	10.67mm	9.91mm	6.75mm	25 Pcs.
12676PK	5-.80mm	.50-3.30mm	7.52mm	12.07mm	10.54mm	7.60mm	25 Pcs.
12678PK	6-1.00mm	.70-4.20mm	9.91mm	14.73mm	12.70mm	10mm	25 Pcs.
12680PK	8-1.25mm	.70-3.80mm	13.46mm	17.53mm	17.40mm	13.50mm	10 Pcs.
12682PK	10-1.50mm	.70-3.80mm	13.46mm	17.53mm	17.40mm	13.50mm	10 Pcs.

5

Nutserts Hex Type

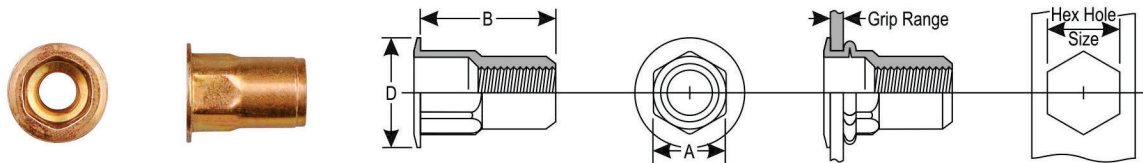

Part #	Thread Size	Grip Range	A	B	D	Drill Size	Qty.
12709PK	6-32	.020 - .080"	.249"	.385"	.375"	1/4"	25 Pcs.
12711PK	8-32	.020 - .080"	.249"	.385"	.375"	1/4"	25 Pcs.
12713PK	10-32	.020 - .130"	.280"	.435"	.390"	9/32"	25 Pcs.
12715PK	1/4-20	.027 - .165"	.374"	.585"	.510"	3/8"	15 Pcs.
12717PK	5/16-18	.027 - .150"	.499"	.685"	.655"	1/2"	10 Pcs.
12719PK	3/8-16	.027 - .150"	.499"	.685"	.655"	1/2"	10 Pcs.
12685PK	4-.70mm	.20 - .30mm	6.35mm	11.05mm	9.53mm	6.35mm	15 Pcs.
10210PK	5-.80mm	.50 - 3.30mm	7.10mm	11.05mm	9.91mm	7.14mm	15 Pcs.
10211PK	6-1.00mm	.70 - 4.20mm	9.50mm	14.86mm	12.96mm	9.53mm	15 Pcs.
12690PK	8-1.25mm	.70 - 3.80mm	12.70mm	17.40mm	16.64mm	12.70mm	15 Pcs.
12692PK	10-1.50mm	.70 - 3.80mm	12.70mm	17.40mm	16.64mm	12.70mm	10 Pcs.

Nuts Acorn With Brass Insert



13242PK
 4-.70mm Thread Size
 12mm Flange Diameter
 10mm Hex Size
 Black Nylon Coated
 Acorn Nuts With Brass Insert
 BMW # 07-13-0-702-715
 Honda # 75307-SN7-000

15 Pcs.







Specialty Nuts



Nuts Acorn With Washer

15862PK	5mm Stud Size 10mm Hex Size 18.50mm Flange Diameter 10.50mm Overall Height Black Nylon Moulding Flange Nuts Audi # 171-201-969	25 Pcs.		
----------------	--	----------------	--	---



Nuts Nylon

18841PK	6mm Stud Size 16mm Flange Outside Diameter 10mm Hex Size 10mm Height Black Nylon Fender Liner Self-Threading Flange Nuts Land Rover # RYH5007780	25 Pcs		
----------------	--	---------------	--	---

16445PK	4.20mm Screw Size 20mm Flange Diameter 13.50mm Over All Height White Nylon Bumper Deflector Flange Nuts G.M. # 11547637	25 Pcs.		
----------------	--	----------------	--	---



17074PK	#8 (4.20mm) Screw Size 20mm Flange Diameter 10mm Hex Size Black Nylon Wheelhouse Liner Nuts G.M. # 11612034	25 Pcs.		
----------------	--	----------------	---	--

16367PK	4.8-1.61mm Screw 30mm Flange Diameter 10mm Hex Size Black Nylon Fender Liner, Apron, & Under Cover Hex Flange Nuts Mercedes # 000-990-31-62	25 Pcs.		
----------------	---	----------------	--	---

18840PK	6mm Screw Size 10mm Hex Size Size 15mm Height 30mm Flange Diameter Black Nylon Splash Shield Nuts Ford # W719534-S300	25 Pcs.		
----------------	---	----------------	--	---

Nuts Jack

1282PK	1/4-20 Thread Size 11/16" Stem Length 1/64 - 3/16" Grip Range Without Sealer Steel Jack Nuts	25 Pcs.		
---------------	--	----------------	--	---

9371PK	1/4-20 Thread Size 5/8" Stem Length 3/16" - 3/8" Grip Range Raintite Sealer Type Steel Jack Nuts Chrysler # 6031438 G.M. # 367292	25 Pcs.		
---------------	---	----------------	--	---

5











Specialty Nuts

Nuts Jack

9541PK	1/4-20 x 1" 5/8" Outside Diameter Chrome Finish Outside Mirror Mounting Bolts Use With # 9371 G.M. # 367291, 10001670, 474821	25 Pcs.		
1793PK	6-1.00mm Thread Size Roof Rack Mounting Raintite Sealer Type Steel Jack Nuts G.M. # 14007940	10 Pcs.		
1589PK	6-1.00 x 26.00mm Chrome Finish Outside Mirror Mounting Bolts Use With # 1793 Ford # N801851-S, N800928-S45, N806345-S47, N806345-S433	25 Pcs.		
9561PK	1/4-20 x 1" Screw Size Mirror Mounting Screw & Jack Nut Assembly G.M. # 367292	10 Sets		

5

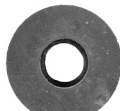
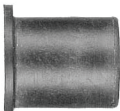
Nuts Brass Insert Rubber Well

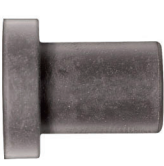
10035PK	8-32 Screw Size 5/16" Hole Size 7/16" Length .015 - .178" Grip Range Black Rubber With Brass Insert Well Nuts G.M. # 14048060	25 Pcs.		
15953PK	10-24 Screw Size 3/8" Hole Size 37/64" Length .030 - .227" Grip Range Black Rubber With Brass Insert Well Nuts G.M. # 3876130	25 Pcs.		
9891PK	10-32 Screw Size 3/8" Hole Size 33/64" Length .015 - .192" Grip Range Black Rubber With Brass Insert Well Nuts	25 Pcs.		
11284PK	10-32 Screw Size 3/8" Hole Size 5/8" Length .035 - .232" Grip Range Black Rubber With Brass Insert Well Nuts G.M. # 12338025	10 Pcs.		
1095PK	1/4-20 Screw Size 1/2" Hole Size 19/32" Length .015 - .111" Grip Range Black Rubber With Brass Insert Well Nuts AMC # 4003120 Chrysler # 2094869, 6033705 G.M. # 528846, 342271	25 Pcs.		
11386PK	1/4-20 Screw Size 1/2" Hole Size 41/64" Length 3/4" Head size Black Rubber With Brass Insert Well Nuts	10 Pcs.		

Specialty Nuts

Nuts Brass Insert Rubber Well

12836PK 5/16-18 Screw Size 15 Pcs.
 5/8" Hole Size
 19/32" Length
 27/32" Flange
 .015 - .156" Grip Range
 Black Rubber With Brass Insert Well Nuts



1284PK 6-1.00mm Screw Size 10 Pcs.
 12.70mm Hole Size
 14.50mm Length
 .015 - .111" Grip Range
 Black Rubber With Brass Insert Well Nuts
 AMC # 8934201293
 G.M. # 15505451



11899PK 6-1.00mm Screw Size 10 Pcs.
 12.70mm Hole Size
 15mm Length
 20mm Flange Diameter
 .015 - .094" Grip Range
 Roof Rack Mounting
 Black Rubber Well Nuts
 G.M. # 20130258, 14002811



5

Kits Brass Insert Rubber Well Nut

13363 6-1.00mm Screw Size 10 Sets
 1/2" Hole Size
 Screw, Washer & Nut
 Top Carrier
 Black Rubber With Brass Insert
 Well Nuts Anchor Kit



Nuts Square Type Cage Standard



Part #	Screw Size	Panel Range	Mounting Hole	Finish	Qty.
11005PK	10-24	.025" - .063"	3/8"	Zinc	50 Pcs.
11006PK	10-24	.064" - .105"	3/8"	Zinc	50 Pcs.
11007PK	10-32	.025" - .063"	3/8"	Zinc	50 Pcs.
11008PK	10-32	.064" - .105"	3/8"	Zinc	50 Pcs.
11009PK	1/4-20	.025" - .063"	3/8"	Zinc	50 Pcs.
11010PK	1/4-20	.064" - .105"	3/8"	Zinc	50 Pcs.
11011PK	5/16-18	.093" - .126"	1/2"	Zinc	50 Pcs.
11012PK	3/8-16	.093" - .126"	1/2"	Zinc	50 Pcs.

Nuts Square Type Cage Metric



Part #	Screw Size	Panel Range	Mounting Hole	Finish	Qty.
11013PK	5-.80mm	1.626" - 2.667"	3/8"	Zinc	50 Pcs.
11014PK	6-1.00mm	.635" - 1.60"	3/8"	Zinc	50 Pcs.
11015PK	6-1.00mm	1.626" - 2.667"	3/8"	Zinc	50 Pcs.

Specialty Nuts

Nuts Air Cleaner Wing

10243PK

1/4 (6.30mm) Screw Size
Natural Nylon
Air Cleaner Hold Down
Wing Nuts
Ford # 386285 AMC # 3230375

10 Pcs.

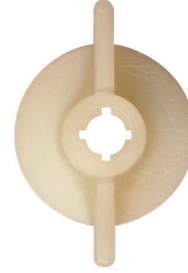

10245PK

1/4-20 Screw Size
Black Nylon
Air Cleaner Hold Down
Wing Nuts
Chrysler # 5240734

10 Pcs.

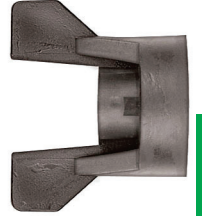

5